

The RF Line

NPN Silicon

RF Power Transistor

MRF6402

4.5 W, 1.88 GHz
RF POWER TRANSISTOR
NPN SILICON

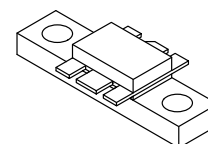

CASE 319-07, STYLE 2

The MRF6402 is designed for 1.8 GHz Personal Communications Network (PCN) base stations applications. It incorporates high value emitter ballast resistors, gold metallizations and offers a high degree of reliability and ruggedness. For ease of design, this transistor has an internally matched input.

- To be used in Class AB for PCN and Cellular Radio Applications
- Specified 26 V, 1.88 GHz Characteristics
 - Output Power — 4.5 Watts
 - Gain — 10 dB Typ
 - Efficiency — 45% Typ
- Circuit board photomaster available upon request by contacting RF Tactical Marketing in Phoenix, AZ.

MAXIMUM RATINGS

Rating	Symbol	Value	Unit
Collector–Emitter Voltage	V_{CER}	40	Vdc
Collector–Base Voltage	V_{CBO}	45	Vdc
Emitter–Base Voltage	V_{EBO}	3.5	Vdc
Collector–Current — Continuous	I_C	0.7	Adc
Total Device Dissipation @ $T_C = 25^\circ\text{C}$ Derate above 25°C	P_D	15 0.2	Watts W/ $^\circ\text{C}$
Storage Temperature Range	T_{stg}	-65 to +150	$^\circ\text{C}$
Operating Junction Temperature	T_J	200	$^\circ\text{C}$

THERMAL CHARACTERISTICS

Characteristic	Symbol	Max	Unit
Thermal Resistance, Junction to Case (1)	$R_{\theta JC}$	5	$^\circ\text{C}/\text{W}$

ELECTRICAL CHARACTERISTICS ($T_C = 25^\circ\text{C}$ unless otherwise noted.)

Characteristic	Symbol	Min	Typ	Max	Unit
Collector–Emitter Breakdown Voltage ($I_C = 10\text{ mA}$, $R_{BE} = 75\ \Omega$)	$V_{(BR)CER}$	40	—	—	Vdc
Emitter–Base Breakdown Voltage ($I_E = 5\text{ mAdc}$)	$V_{(BR)EBO}$	3.5	—	—	Vdc
Collector–Base Breakdown Voltage ($I_C = 10\text{ mAdc}$)	$V_{(BR)CBO}$	40	—	—	Vdc
Collector–Emitter Leakage ($V_{CE} = 26\text{ V}$, $R_{BE} = 75\ \Omega$)	I_{CER}	—	—	5	mA

(1) Thermal resistance is determined under specified RF operating condition.

(continued)

ELECTRICAL CHARACTERISTICS — continued ($T_C = 25^\circ\text{C}$ unless otherwise noted.)

Characteristic	Symbol	Min	Typ	Max	Unit
ON CHARACTERISTICS					
DC Current Gain ($I_C = 0.1 \text{ Adc}$, $V_{CE} = 20 \text{ Vdc}$)	h_{FE}	50	—	200	—
DYNAMIC CHARACTERISTICS					
Output Capacitance ($V_{CB} = 26 \text{ V}$, $I_E = 0$, $f = 1 \text{ MHz}$)	C_{ob}	—	6	—	pF
FUNCTIONAL TESTS					
Common-Emitter Amplifier Power Gain ($V_{CC} = 26 \text{ V}$, $P_{out} = 4 \text{ W}$, $I_{CQ} = 40 \text{ mA}$, $f = 1.88 \text{ GHz}$)	G_p	9	10	—	dB
Collector Efficiency ($V_{CC} = 26 \text{ V}$, $P_{out} = 4 \text{ W}$, $f = 1.88 \text{ GHz}$)	η	40	43	—	%
Load Mismatch ($V_{CC} = 26 \text{ V}$, $P_{out} = 4.5 \text{ W}$, $I_{CQ} = 40 \text{ mA}$, $f = 1.88 \text{ GHz}$, Load VSWR = 3:1, All Phase Angles at Frequency of Test)	Ψ	No Degradation in Output Power			

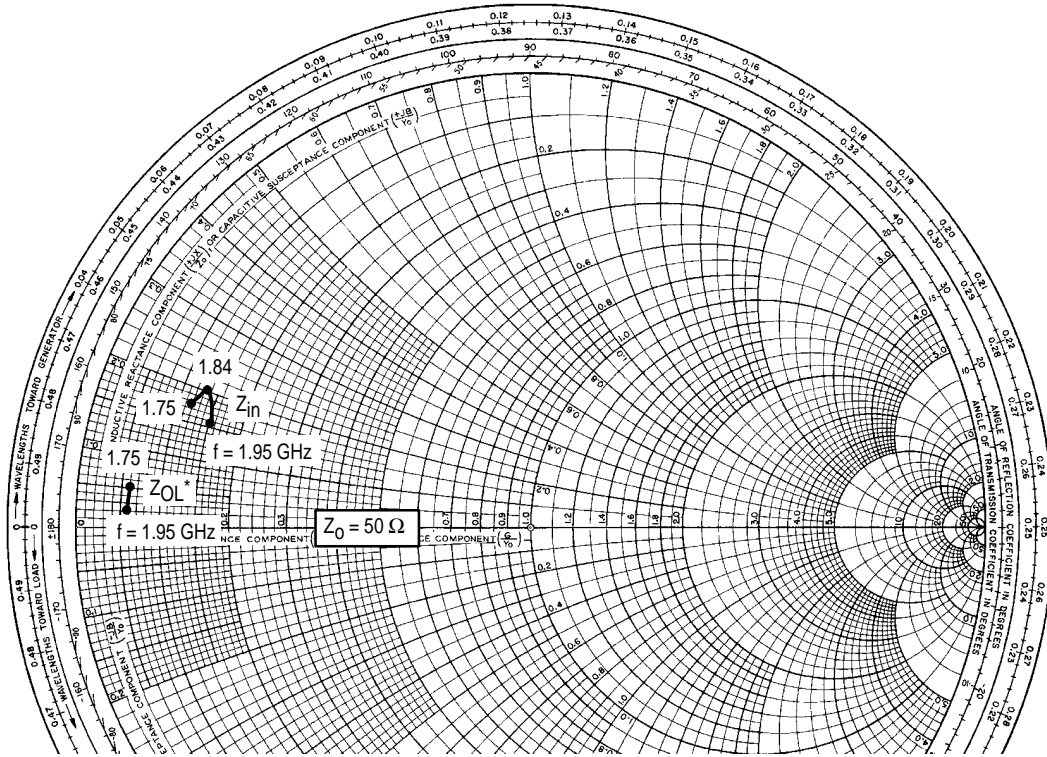

f (GHz)	Z_{in} (Ω)	Z_{OL}^* (Ω)
1.75	$0.12 + j0.18$	$0.06 + j0.05$
1.84	$0.13 + j0.2$	$0.06 + j0.04$
1.95	$0.15 + j0.16$	$0.06 + j0.02$

Z_{OL}^* : Conjugate of optimum load impedance into which the device operates at a given output power, voltage, current and frequency.

Figure 1. Input and Output Impedances with Circuit Tuned for Maximum Gain @ $V_{CE} = 26 \text{ V}$, $I_{CQ} = 40 \text{ mA}$, $P_{out} = 4.5 \text{ W}$

TYPICAL CHARACTERISTICS

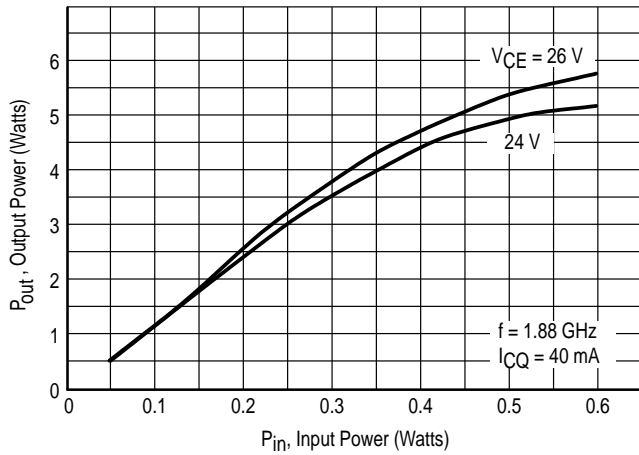

Figure 2. Typical Output Power versus Input Power

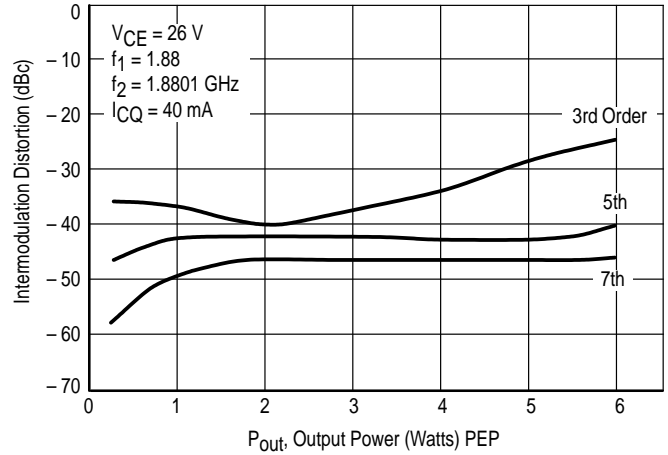
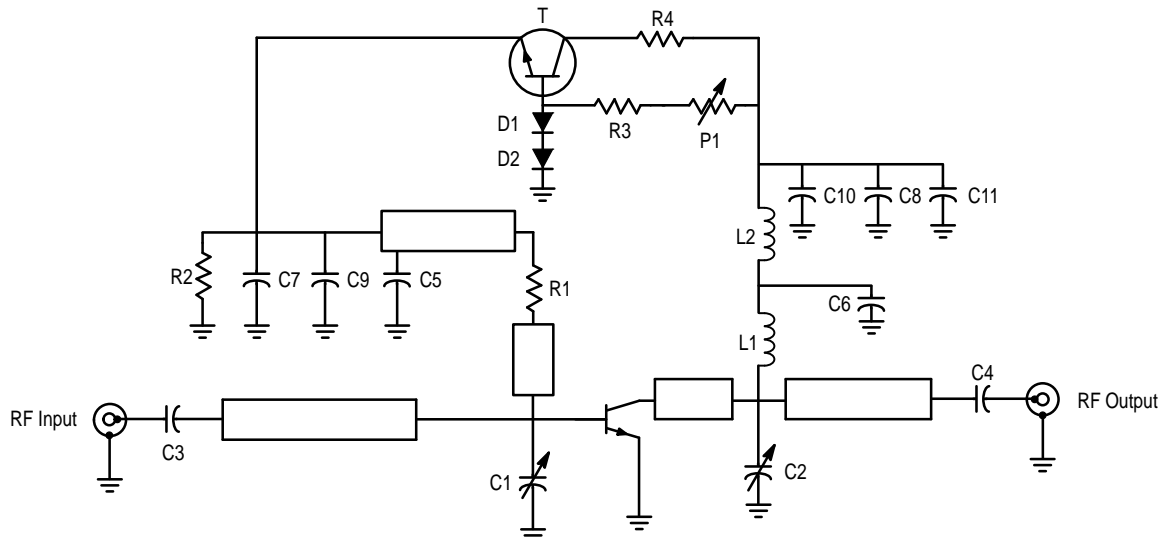

Figure 3. IMD versus Output Power



C1, C2	1 to 5 pF, Trimmer Capacitor, Johanson	L1	2 Turns, Wire 0.5 mm, ID 2 mm
C3, C4	100A, 68 pF, Chip Capacitor, ATC	L2	Ferrite Bead, SMD Fair-Rite
C5, C6	100A, 82 pF, Chip Capacitor, ATC	P1	10 kΩ, Trimmer
C7, C8	15 nF, Chip Capacitor, 0805	R1	2.2 Ω, Chip Resistor, 0805
C9, C10	330 pF, Chip Capacitor, 0805	R2	56 Ω, Chip Resistor, 1206
C11	4.7 μF, 35 V, Capacitor	R3	1.2 kΩ, 1/4 W, 5%, Resistor
D1, D2	Diode, 1N4148	R4	100 Ω, 3 W, Power Resistor
		T	Transistor, BD135

Figure 4. 1.80–1.88 GHz Test Circuit Electrical Schematic

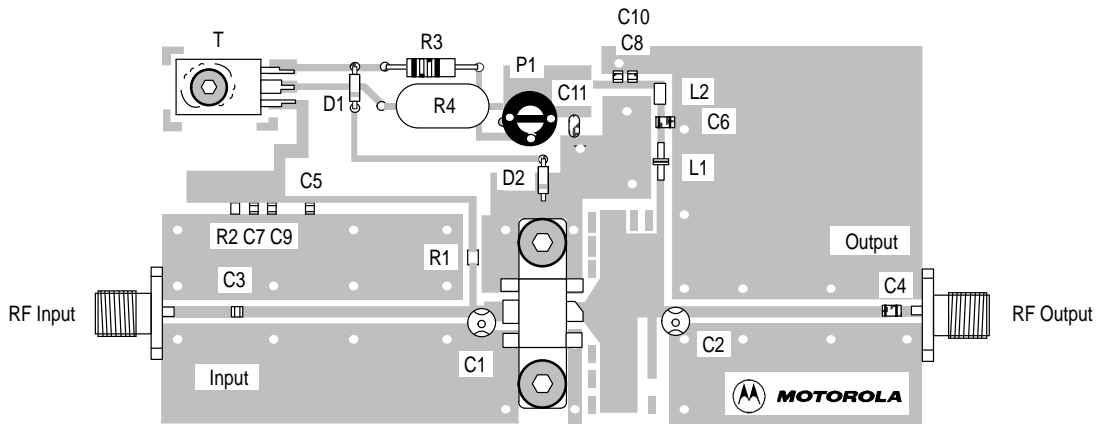
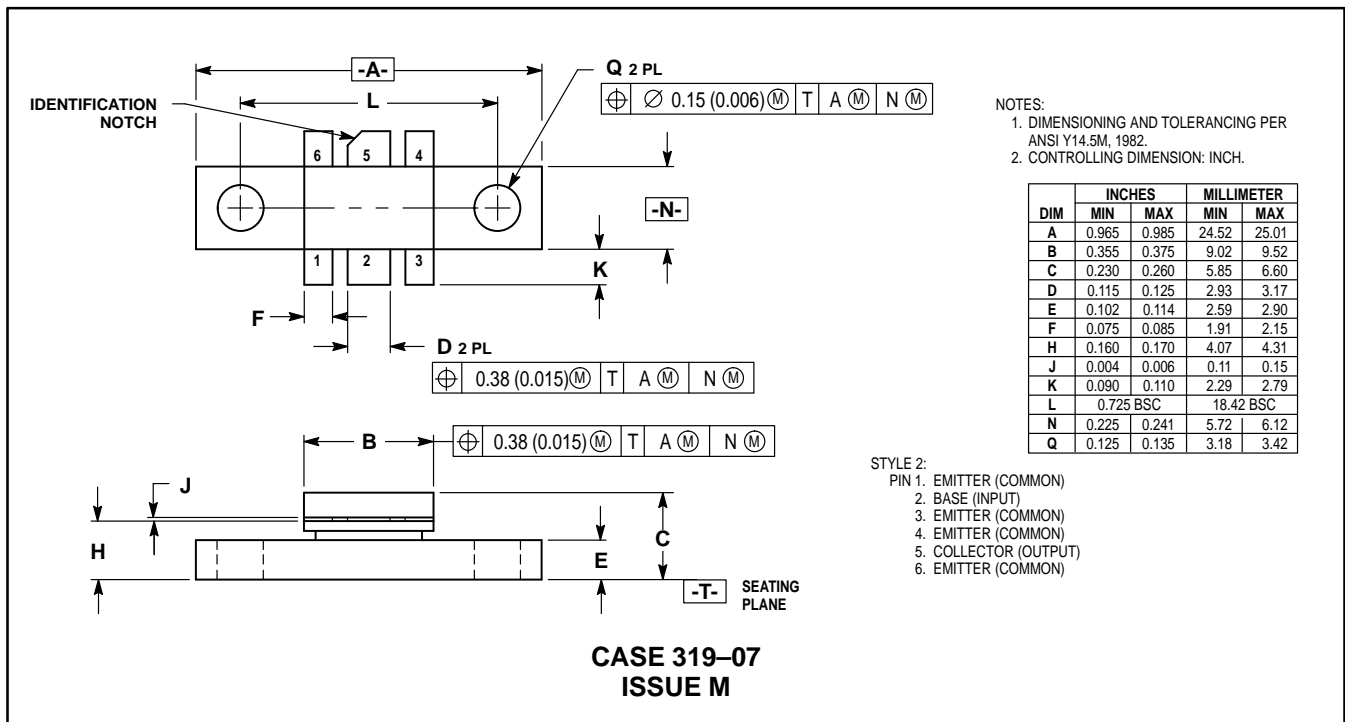

Figure 5. Test Circuit Components View and Parts List

PACKAGE DIMENSIONS



Motorola reserves the right to make changes without further notice to any products herein. Motorola makes no warranty, representation or guarantee regarding the suitability of its products for any particular purpose, nor does Motorola assume any liability arising out of the application or use of any product or circuit, and specifically disclaims any and all liability, including without limitation consequential or incidental damages. "Typical" parameters which may be provided in Motorola data sheets and/or specifications can and do vary in different applications and actual performance may vary over time. All operating parameters, including "Typicals" must be validated for each customer application by customer's technical experts. Motorola does not convey any license under its patent rights nor the rights of others. Motorola products are not designed, intended, or authorized for use as components in systems intended for surgical implant into the body, or other applications intended to support or sustain life, or for any other application in which the failure of the Motorola product could create a situation where personal injury or death may occur. Should Buyer purchase or use Motorola products for any such unintended or unauthorized application, Buyer shall indemnify and hold Motorola and its officers, employees, subsidiaries, affiliates, and distributors harmless against all claims, costs, damages, and expenses, and reasonable attorney fees arising out of, directly or indirectly, any claim of personal injury or death associated with such unintended or unauthorized use, even if such claim alleges that Motorola was negligent regarding the design or manufacture of the part. Motorola and are registered trademarks of Motorola, Inc. Motorola, Inc. is an Equal Opportunity/Affirmative Action Employer.

Mfax is a trademark of Motorola, Inc.

How to reach us:

USA/EUROPE/Locations Not Listed: Motorola Literature Distribution;
 P.O. Box 5405, Denver, Colorado 80217. 303-675-2140 or 1-800-441-2447

JAPAN: Nippon Motorola Ltd.: SPD, Strategic Planning Office, 4-32-1,
 Nishi-Gotanda, Shinagawa-ku, Tokyo 141, Japan. 81-3-5487-8488

Mfax™: RMFAX0@email.sps.mot.com – TOUCHTONE 602-244-6609
 – US & Canada ONLY 1-800-774-1848

ASIA/PACIFIC: Motorola Semiconductors H.K. Ltd.; 8B Tai Ping Industrial Park,
 51 Ting Kok Road, Tai Po, N.T., Hong Kong. 852-26629298

INTERNET: <http://motorola.com/sp>

