

**APPLICATION**

- ◆ Fast Switching
- ◆ Simple Drive Requirement
- ◆ Low Gate Charge

$V_{DSS}$	$R_{DS(ON)}$ Max.	$I_D$
30V	17.0mΩ	40A

**PIN CONFIGURATION**

TO-220  
Front View

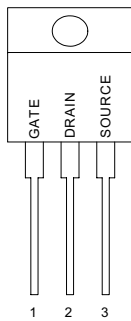

**FEATURES**

- ◆ Low ON Resistance
- ◆ Low Gate Charge
- ◆ Peak Current vs Pulse Width Curve
- ◆ Inductive Switching Curves

**SYMBOL**

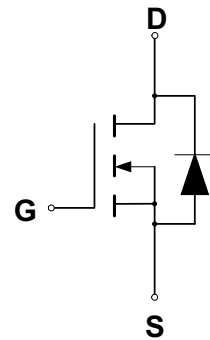

N-Channel MOSFET

**ABSOLUTE MAXIMUM RATINGS**

Rating	Symbol	Value	Unit
Drain to Source Voltage (Note 1)	$V_{DSS}$	30	V
Drain to Current — Continuous $T_c = 25^\circ\text{C}$ , $V_{GS}@10\text{V}$	$I_D$	40	A
	$I_D$	30	
	$I_{DM}$	170	
Gate-to-Source Voltage — Continue	$V_{GS}$	$\pm 20$	V
Total Power Dissipation	$P_D$	50	W
		0.4	W/°C
Peak Diode Recovery dv/dt (Note 3)	dv/dt	4.5	V/ns
Operating Junction and Storage Temperature Range	$T_J, T_{STG}$	-55 to 175	°C
Single Pulse Avalanche Energy $L=144\mu\text{H}, I_p=40$ Amps	$E_{AS}$	500	mJ
Maximum Lead Temperature for Soldering Purposes	$T_L$	300	°C
Maximum Package Body for 10 seconds	$T_{PKG}$	260	°C
Pulsed Avalanche Rating	$I_{AS}$	60	A

**THERMAL RESISTANCE**

Symbol	Parameter	Min	Typ	Max	Units	Test Conditions
$R_{\theta JC}$	Junction-to-case			2.5	°C	Water cooled heatsink, $P_D$ adjusted for a peak junction temperature of +175°C
$R_{\theta JA}$	Junction-to-ambient			62	°C/W	1 cubic foot chamber, free air

### ORDERING INFORMATION

Part Number	Package
IRF40N03	TO-220

### ELECTRICAL CHARACTERISTICS

Unless otherwise specified,  $T_J = 25^\circ\text{C}$ .

		IRF40N03				
Characteristic	Symbol	Min	Typ	Max	Units	
<b>OFF Characteristics</b>						
Drain-to-Source Breakdown Voltage ( $V_{GS} = 0\text{ V}$ , $I_D = 250\ \mu\text{A}$ )	$V_{DSS}$	30			V	
Breakdown Voltage Temperature Coefficient (Reference to $25^\circ\text{C}$ , $I_D = 1\text{ mA}$ )	$\Delta V_{DSS}/\Delta T_J$		0.037		$\text{V}/^\circ\text{C}$	
Drain-to-Source Leakage Current ( $V_{DS} = 30\text{ V}$ , $V_{GS} = 0\text{ V}$ , $T_J = 25^\circ\text{C}$ ) ( $V_{DS} = 24\text{ V}$ , $V_{GS} = 0\text{ V}$ , $T_J = 150^\circ\text{C}$ )	$I_{DSS}$			1 25	$\mu\text{A}$	
Gate-to-Source Forward Leakage ( $V_{GS} = 20\text{ V}$ )	$I_{GSS}$			100	nA	
Gate-to-Source Reverse Leakage ( $V_{GS} = -20\text{ V}$ )	$I_{GSS}$			-100	nA	
<b>ON Characteristics</b>						
Gate Threshold Voltage ( $V_{DS} = V_{GS}$ , $I_D = 250\ \mu\text{A}$ )	$V_{GS(th)}$	1.0	2.0	3.0	V	
Static Drain-to-Source On-Resistance (Note 4) ( $V_{GS} = 10\text{ V}$ , $I_D = 20\text{ A}$ )	$R_{DS(on)}$		14	17	m $\Omega$	
Forward Transconductance ( $V_{DS} = 10\text{ V}$ , $I_D = 20\text{ A}$ ) (Note 4)	$g_{FS}$		26		S	
<b>Dynamic Characteristics</b>						
Input Capacitance	$(V_{DS} = 25\text{ V}$ , $V_{GS} = 0\text{ V}$ , $f = 1.0\text{ MHz}$ )	$C_{iss}$		800	pF	
Output Capacitance		$C_{oss}$		380	pF	
Reverse Transfer Capacitance		$C_{rss}$		133	pF	
Total Gate Charge ( $V_{GS} = 10\text{ V}$ )	$(V_{DS} = 24\text{ V}$ , $I_D = 20\text{ A}$ , $V_{GS} = 5\text{ V}$ ) (Note 5)	$Q_g$		17	nC	
Gate-to-Source Charge		$Q_{gs}$		3	nC	
Gate-to-Drain ("Miller") Charge		$Q_{gd}$		10	nC	
<b>Resistive Switching Characteristics</b>						
Turn-On Delay Time	$(V_{DS} = 15\text{ V}$ , $I_D = 20\text{ A}$ , $V_{GS} = 10\text{ V}$ , $R_G = 3.3\ \Omega$ ) (Note 5)	$t_{d(on)}$		7.2	ns	
Rise Time		$t_{rise}$		60	ns	
Turn-Off Delay Time		$t_{d(off)}$		22.5	ns	
Fall Time		$t_{fall}$		10	ns	
<b>Source-Drain Diode Characteristics</b>						
Continuous Source Current (Body Diode)	Integral pn-diode in MOSFET	$I_S$			40	A
Pulse Source Current (Body Diode)		$I_{SM}$			170	A
Diode Forward On-Voltage ( $I_S = 40\text{ A}$ , $V_{GS} = 0\text{ V}$ )		$V_{SD}$			1.3	V
Reverse Recovery Time ( $I_F = 40\text{ A}$ , $V_{GS} = 0\text{ V}$ ,		$t_{rr}$		55	ns	
Reverse Recovery Charge $di/dt = 100\text{ A}/\mu\text{s}$ )		$Q_{rr}$		110	nC	

Note 1:  $T_J = +25^\circ\text{C}$  to  $150^\circ\text{C}$

Note 2: Repetitive rating; pulse width limited by maximum junction temperature.

Note 3:  $I_{SD} = 12.0\text{ A}$ ,  $di/dt \leq 100\text{ A}/\mu\text{s}$ ,  $V_{DD} \leq BV_{DSS}$ ,  $T_J = +150^\circ\text{C}$

Note 4: Pulse width  $\leq 250\ \mu\text{s}$ ; duty cycle  $\leq 2\%$

Note 5: Essentially independent of operating temperature.

TYPICAL ELECTRICAL CHARACTERISTICS

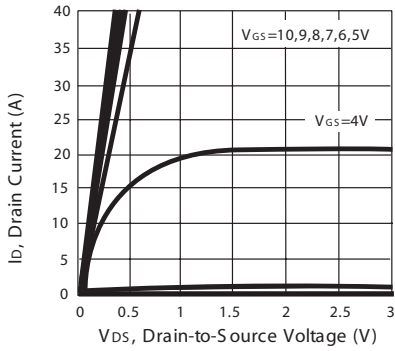

Figure 1. Output Characteristics

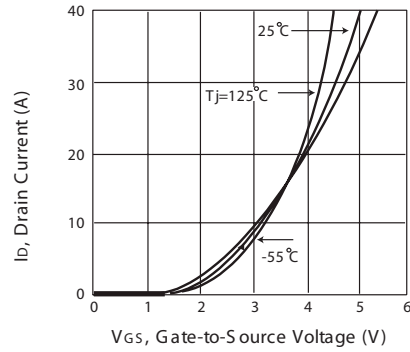

Figure 2. Transfer Characteristics

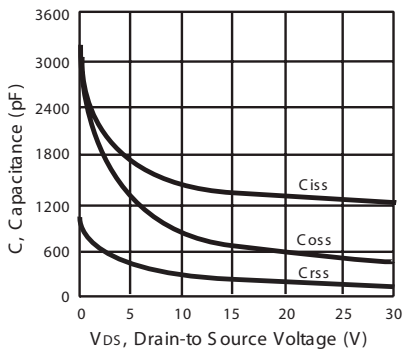

Figure 3. Capacitance

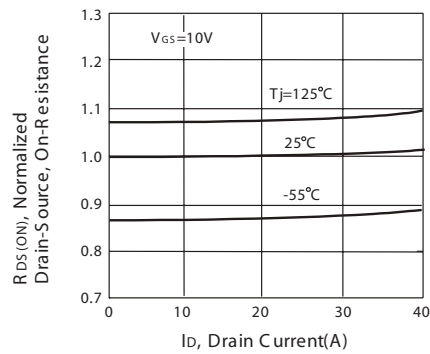

Figure 4. On-Resistance Variation with Drain Current and Temperature

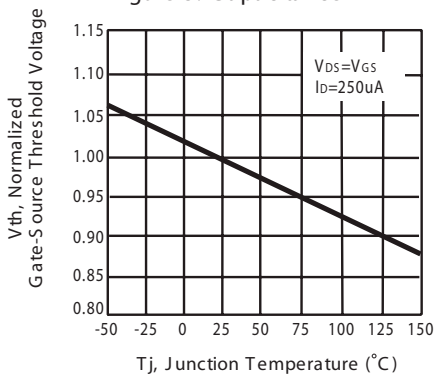

Figure 5. Gate Threshold Variation with Temperature

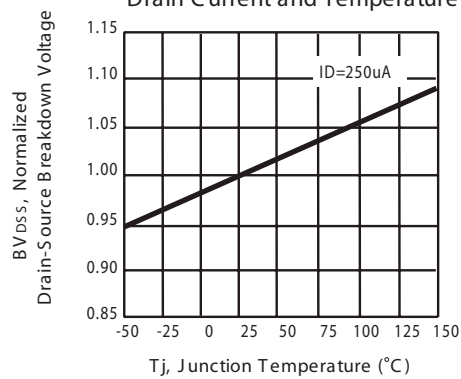

Figure 6. Breakdown Voltage Variation with Temperature

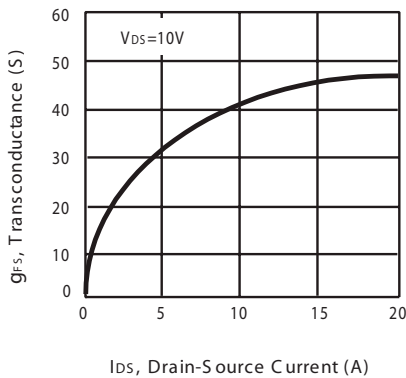

Figure 7. Transconductance Variation with Drain Current

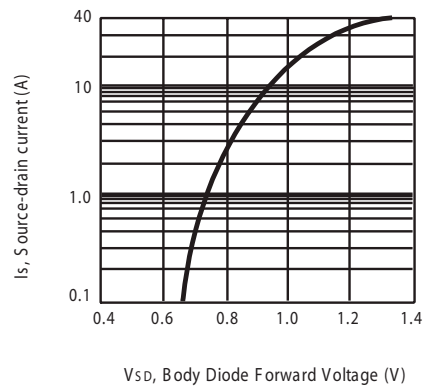

Figure 8. Body Diode Forward Voltage Variation with Source Current

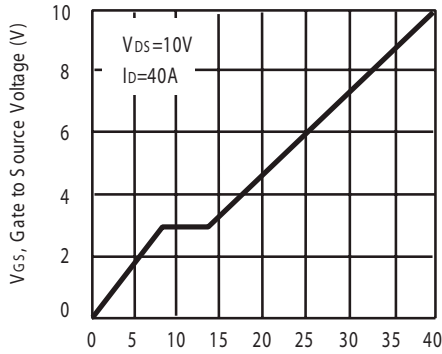

Figure 9. Gate Charge

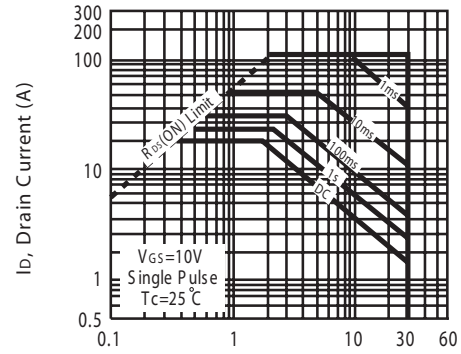

Figure 10. Maximum Safe Operating Area

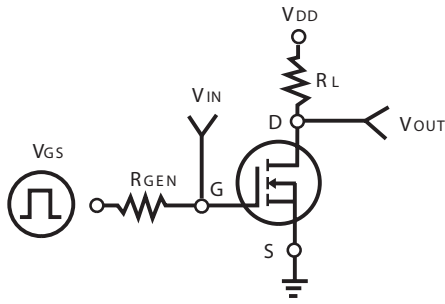

Figure 11. Switching Test Circuit

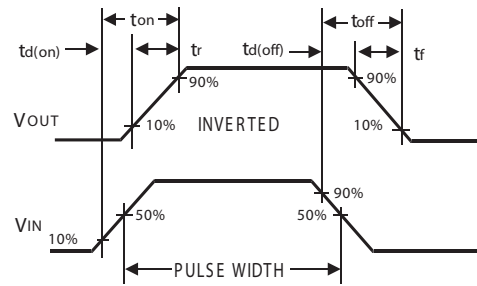

Figure 12. Switching Waveforms

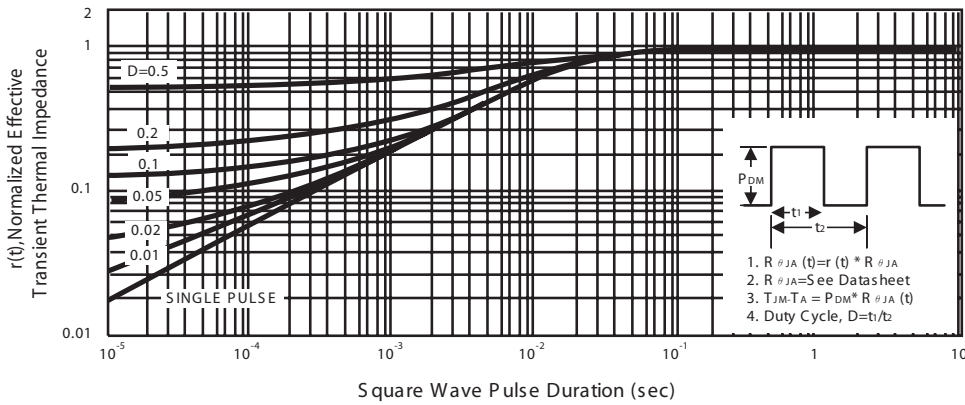

Figure 13. Normalized Thermal Transient Impedance Curve