

KSM - 60 ** LF · KSM - 70 ** LF

The KSM - 60**LF consist of a PIN Photodiode of high speed and a preamplifier IC in the package as an receiver for Infrared remote control systems

FEATURES

- One mold small package
- 5 Volt supply voltage, low power consumption
- Shielded against electrical field disturbance
- High immunity against ambient light
- Easy interface with the main board
- TTL and CMOS compatibility

APPLICATIONS

- TV, VTR, Acoustic Devices, Air Conditioners, Car Stereo Units, Computers, Interior controlling appliances, and all appliances that require remote controlling

DIMENSIONS

(Unit : mm)

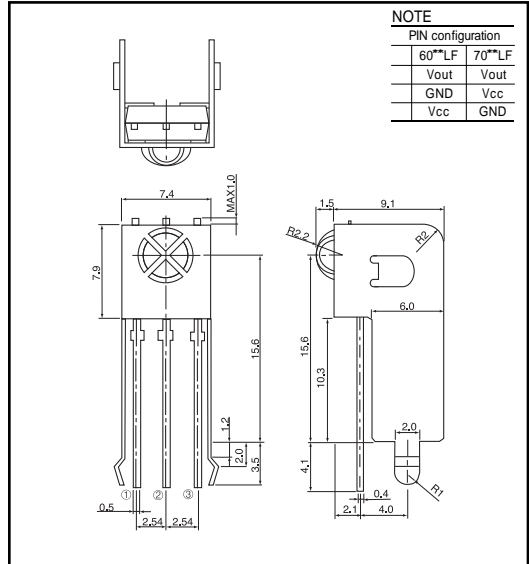

MAXIMUM RATINGS

(Ta=25 Unless otherwise noted)

Parameter	Symbol	Rating	Unit
Supply Voltage	Vcc	5.5	V
Operating Temperature	Topr.	- 10 ~ +60	
Storage Temperature	Tstg.	- 20 ~ +75	
Soldering Temperature	Tsol.	260(Max 5 sec)	

B.P.F CENTER FREQUENCY

Model NO.	B.P.F Center Frequency(kHz)
KSM - 1 LF	40.0
KSM - 2 LF	36.7
KSM - 3 LF	37.9
KSM - 4 LF	32.7
KSM - 5 LF	56.9

ELECTRO-OPTICAL CHARACTERISTICS

(Ta=25), Vcc=5.0V

Parameter	Symbol	Conditions	Min.	Typ.	Max.	Unit.
Supply Voltage	Vcc		4.5	5.0	5.5	V
Current Consumption	Icc	Input Signal=0	-	1.2	2.5	mA
Peak Wavelength *1	p		-	940	-	nm
B.P.F Center Frequency	fo		-	37.9	-	kHz
Transmission Distance *1	L	200 ± 50x	0p	10	-	m
			± 30p	7	-	m
H Level Output Voltage *1	V _{OH}	30cm over the ray axis	4.5	5.0	-	V
L Level Output Voltage *1	V _{OL}		-	0.1	0.5	V
H Level Output Pulse Width *1	T _{WH}	Burst Wave=600 μs Period=1.2ns	500	600	700	μs
L Level Output Pulse Width *1	T _{WL}		500	600	700	μs
Output Form			Active Low Output			

Note : *1. It specifies the maximum distance between emitter and detector that the output waveform satisfies the standard under the conditions below against the standard transmitter

1) Measuring place : Indoor without extreme reflection of light

2) Ambient light source : Detecting surface illumination shall be irradiate 200 ± 50lx under ordinary white fluorescence lamp without high frequency lightning

3) Standard transmitter : Burst wave of standard transmitter shall be arranged to 50mVp - p under the measuring circuit

Optic receiver modules

KSM - 60 * LF · KSM - 70 *** LF**

MEASURING METHOD

Output Pulse Width

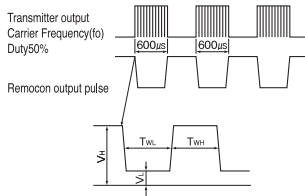

Standard Transmitter

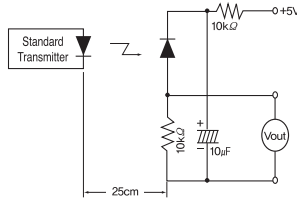

Test Condition of Transmission Distance

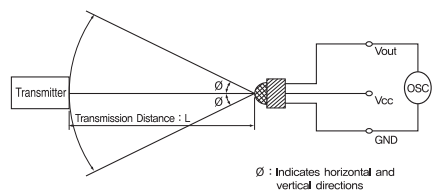

Relative reception distance Vs. Frequency(37.9kHz)

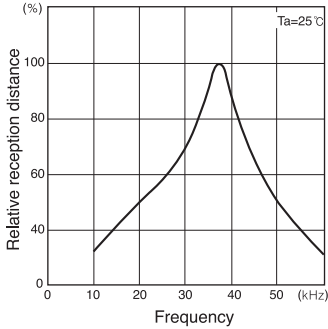

Relative reception distance Vs. Power supply voltage

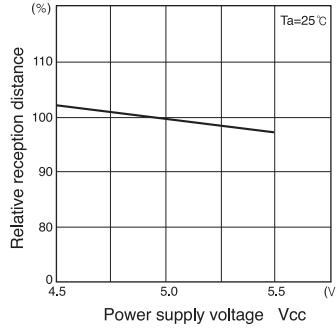

Relative distance Vs. Supply current

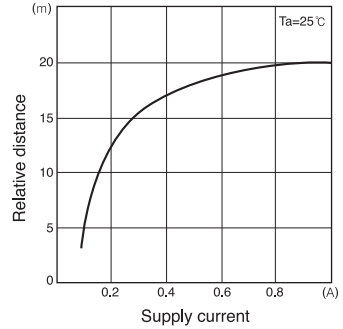

Relative reception distance Vs. Ambient temperature

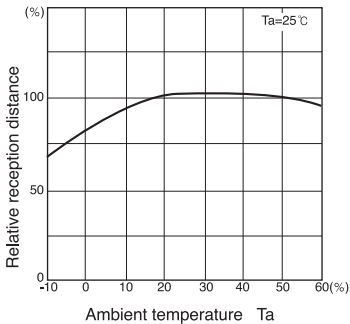

Radiant pattern

