

**MOC215-M**

**MOC216-M**

**MOC217-M**

**DESCRIPTION**

These devices consist of a gallium arsenide infrared emitting diode optically coupled to a monolithic silicon phototransistor detector, in a surface mountable, small outline, plastic package. They are ideally suited for high density applications, and eliminate the need for through-the-board mounting.

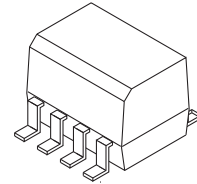

**FEATURES**

- UL Recognized (File #E90700, Volume 2)
- VDE Recognized (File #13616) (add option "V" for VDE approval, i.e., MOC215V-M)
- Convenient Plastic SOIC-8 Surface Mountable Package Style
- Low LED Input Current Required, for Easier Logic Interfacing
- Standard SOIC-8 Footprint, with 0.050" Lead Spacing
- Compatible with Dual Wave, Vapor Phase and IR Reflow Soldering
- High Input-Output Isolation of 2500 Vac (rms) Guaranteed

**APPLICATIONS**

- Low power Logic Circuits
- Interfacing and coupling systems of different potentials and impedances
- Telecommunications equipment
- Portable electronics

**Marking Information:**

- MOC215-M = 215
- MOC216-M = 216
- MOC217-M = 217

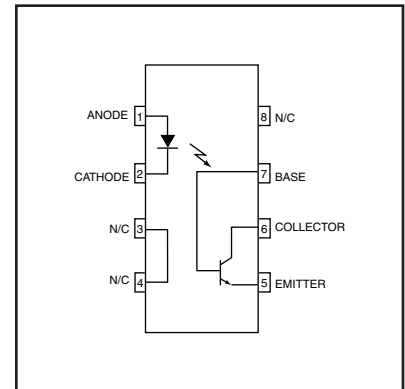

**MOC215-M**

**MOC216-M**

**MOC217-M**

<b>ABSOLUTE MAXIMUM RATINGS</b> ( $T_A = 25^\circ\text{C}$ Unless otherwise specified)			
<b>Rating</b>	<b>Symbol</b>	<b>Value</b>	<b>Unit</b>
<b>EMITTER</b>			
Forward Current - Continuous	$I_F$	60	mA
Forward Current - Peak (PW = 100 $\mu\text{s}$ , 120 pps)	$I_F$ (pk)	1.0	A
Reverse Voltage	$V_R$	6.0	V
LED Power Dissipation @ $T_A = 25^\circ\text{C}$ Derate above $25^\circ\text{C}$	$P_D$	90 0.8	mW mW/ $^\circ\text{C}$
<b>DETECTOR</b>			
Collector-Emitter Voltage	$V_{CEO}$	30	V
Collector-Base Voltage	$V_{CBO}$	70	V
Emitter-Collector Voltage	$V_{ECO}$	7.0	V
Collector Current-Continuous	$I_C$	150	mA
Detector Power Dissipation @ $T_A = 25^\circ\text{C}$ Derate above $25^\circ\text{C}$	$P_D$	150 1.76	mW mW/ $^\circ\text{C}$
<b>TOTAL DEVICE</b>			
Input-Output Isolation Voltage <sup>(1,2)</sup> (60 Hz, 1 minute duration)	$V_{ISO}$	2500	Vac(rms)
Total Device Power Dissipation @ $T_A = 25^\circ\text{C}$ Derate above $25^\circ\text{C}$	$P_D$	250 2.94	mW mW/ $^\circ\text{C}$
Ambient Operating Temperature Range	$T_A$	-40 to +100	$^\circ\text{C}$
Storage Temperature Range	$T_{stg}$	-40 to +125	$^\circ\text{C}$

**MOC215-M**

**MOC216-M**

**MOC217-M**

<b>ELECTRICAL CHARACTERISTICS</b> ( $T_A = 25^\circ\text{C}$ Unless otherwise specified)						
Characteristic		Symbol	Min	Typ**	Max	Unit
<b>EMITTER</b>						
Forward Voltage	( $I_F = 1.0\text{ mA}$ )	$V_F$	—	1.07	1.3	V
Reverse Leakage Current	( $V_R = 6.0\text{ V}$ )	$I_R$	—	0.001	100	$\mu\text{A}$
Capacitance		C	—	18	—	pF
<b>DETECTOR</b>						
Collector-Emitter Dark Current	( $V_{CE} = 5.0\text{ V}, T_A = 25^\circ\text{C}$ )	$I_{CEO}$	—	1.0	50	nA
	( $V_{CE} = 5.0\text{ V}, T_A = 100^\circ\text{C}$ )		—	1.0	—	$\mu\text{A}$
Collector-Emitter Breakdown Voltage	( $I_C = 100\ \mu\text{A}$ )	$BV_{CEO}$	30	100	—	V
Emitter-Collector Breakdown Voltage	( $I_E = 100\ \mu\text{A}$ )	$BV_{ECO}$	7.0	10	—	V
Collector-Emitter Capacitance	( $f = 1.0\text{ MHz}, V_{CE} = 0$ )	$C_{CE}$	—	7.0	—	pF
<b>COUPLED</b>						
Output Collector Current <sup>(4)</sup>	MOC215-M MOC216-M MOC217-M	$I_C$	20 50 100	— — —	— — —	%
	( $I_F = 1.0\text{ mA}, V_{CE} = 5.0\text{ V}$ )					
Collector-Emitter Saturation Voltage	( $I_C = 100\ \mu\text{A}, I_F = 1.0\text{ mA}$ )					
Turn-On Time	( $I_C = 2.0\text{ mA}, V_{CC} = 10\text{ V}, R_L = 100\ \Omega$ , fig. 10)	$t_{on}$	—	4.0	—	$\mu\text{s}$
Turn-Off Time	( $I_C = 2.0\text{ mA}, V_{CC} = 10\text{ V}, R_L = 100\ \Omega$ , fig. 10)	$t_{off}$	—	4.0	—	$\mu\text{s}$
Rise Time	( $I_C = 2.0\text{ mA}, V_{CC} = 10\text{ V}, R_L = 100\ \Omega$ , fig. 10)	$t_r$	—	3.0	—	$\mu\text{s}$
Fall Time	( $I_C = 2.0\text{ mA}, V_{CC} = 10\text{ V}, R_L = 100\ \Omega$ , fig. 10)	$t_f$	—	3.0	—	$\mu\text{s}$
Input-Output Isolation Voltage <sup>(1,2,3)</sup>	( $f = 60\text{ Hz}, t = 1.0\text{ min.}$ )	$V_{ISO}$	2500	—	—	Vac(rms)
Isolation Resistance <sup>(2)</sup>	( $V_{I-O} = 500\text{ V}$ )	$R_{ISO}$	$10^{11}$	—	—	$\Omega$
Isolation Capacitance <sup>(2)</sup>	( $V_{I-O} = 0, f = 1.0\text{ MHz}$ )	$C_{ISO}$	—	0.2	—	pF

\*\* Typical values at  $T_A = 25^\circ\text{C}$  unless otherwise noted.

1. Input-Output Isolation Surge Voltage,  $V_{ISO}$ , is an internal device dielectric breakdown rating.
2. For this test, Pins 1 and 2 are common and Pins 5, 6 and 7 are common.
3.  $V_{ISO}$  rating of 2,500  $V_{AC(RMS)}$  for  $t = 1$  minute is equivalent to a rating of 3,000  $V_{AC(RMS)}$  for  $t = 1$  second.
4. Current Transfer Ratio (CTR) =  $I_C/I_F \times 100\%$ .

**MOC215-M**

**MOC216-M**

**MOC217-M**

**Fig. 1 LED Forward Voltage vs. Forward Current**

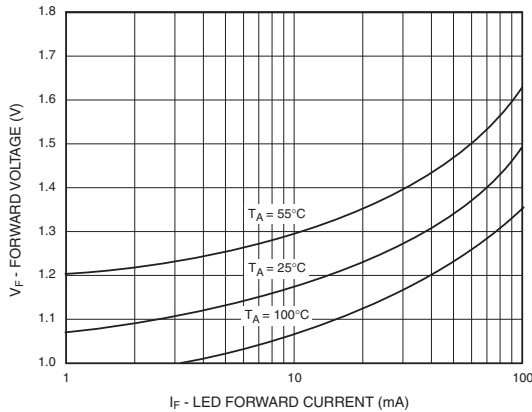

**Fig. 2 Output Current vs. Input Current**

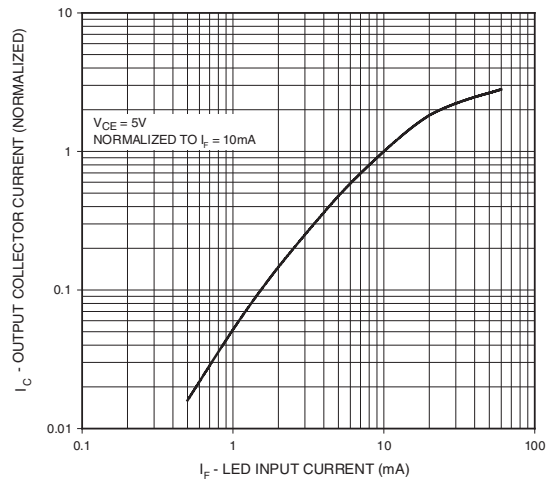

**Fig. 3 Output Current vs. Ambient Temperature**

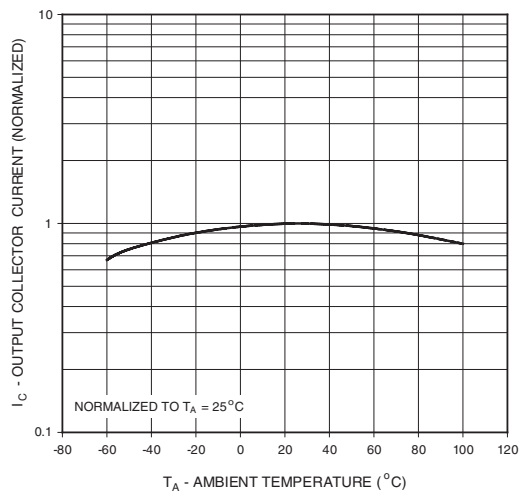

**Fig. 4 Output Current vs. Collector - Emitter Voltage**

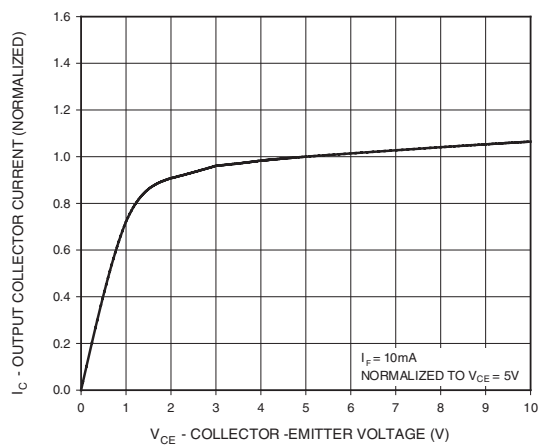

**Fig. 5 Dark Current vs. Ambient Temperature**

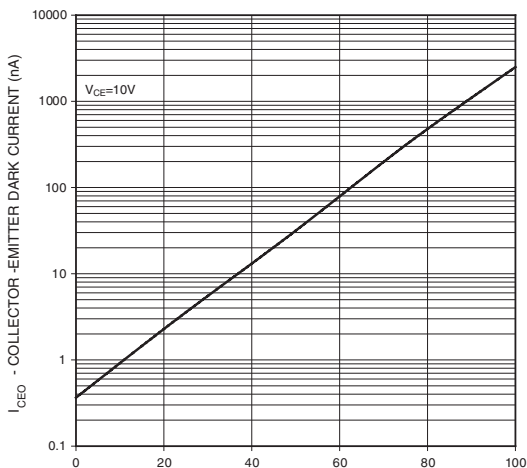

**Fig. 6 Normalized ton vs. RBE**

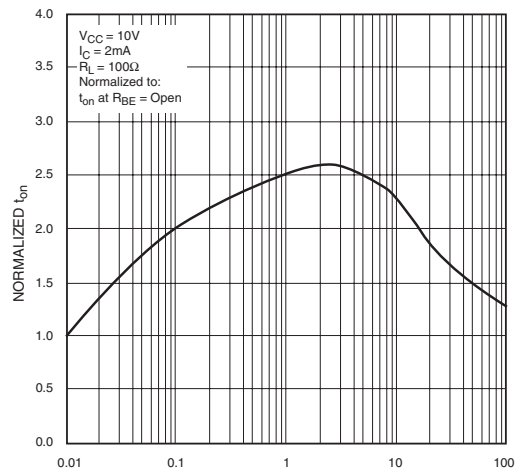

**MOC215-M**

**MOC216-M**

**MOC217-M**

Fig. 7 Normalized  $t_{off}$  vs.  $R_{BE}$

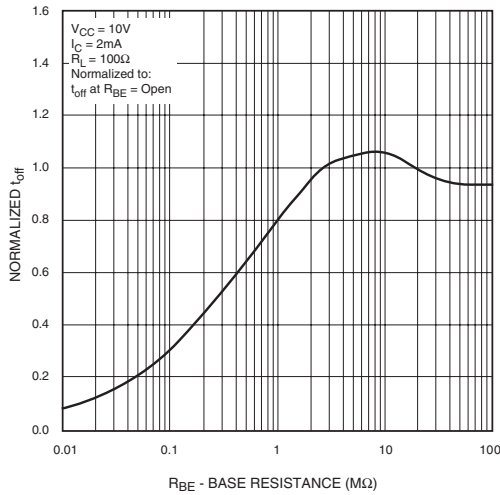

Fig. 8 CTR vs.  $R_{BE}$  (Saturated)

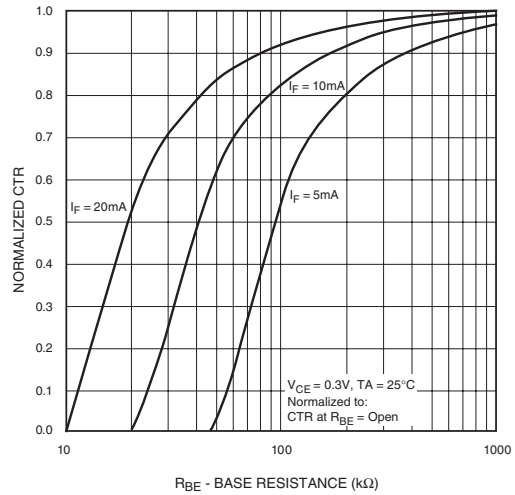
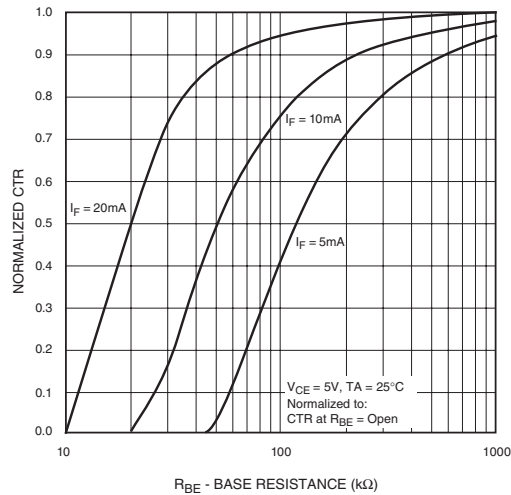

Fig. 9 CTR vs.  $R_{BE}$  (Unsaturated)



**MOC215-M**

**MOC216-M**

**MOC217-M**

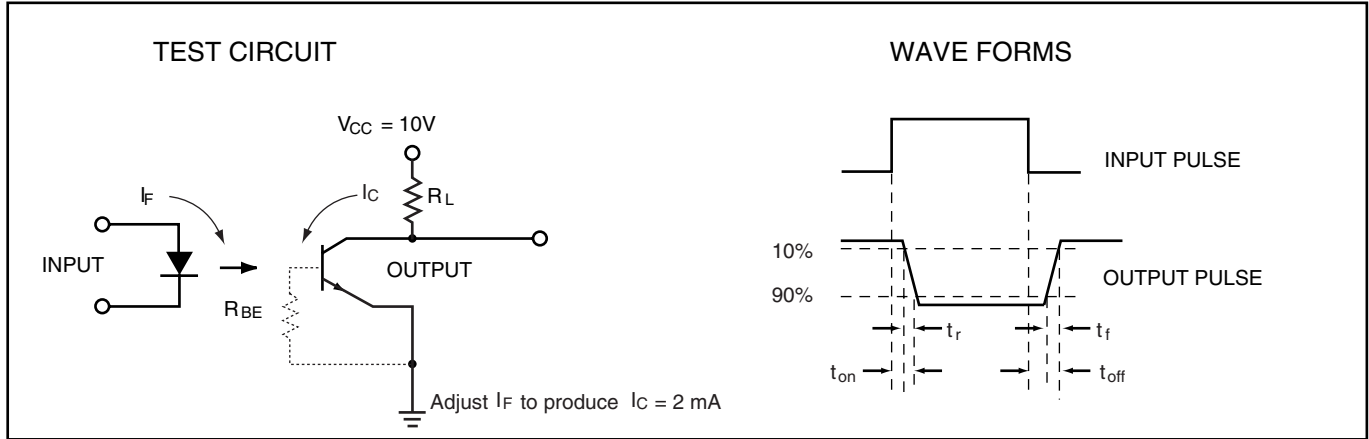
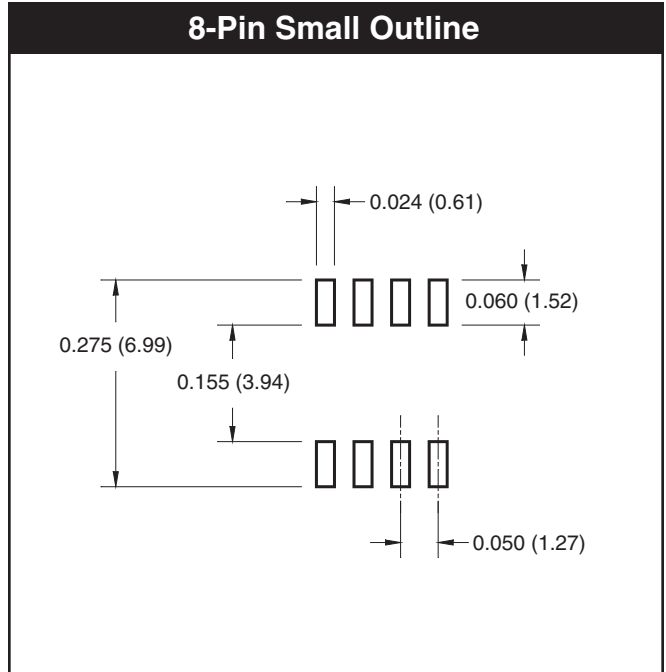
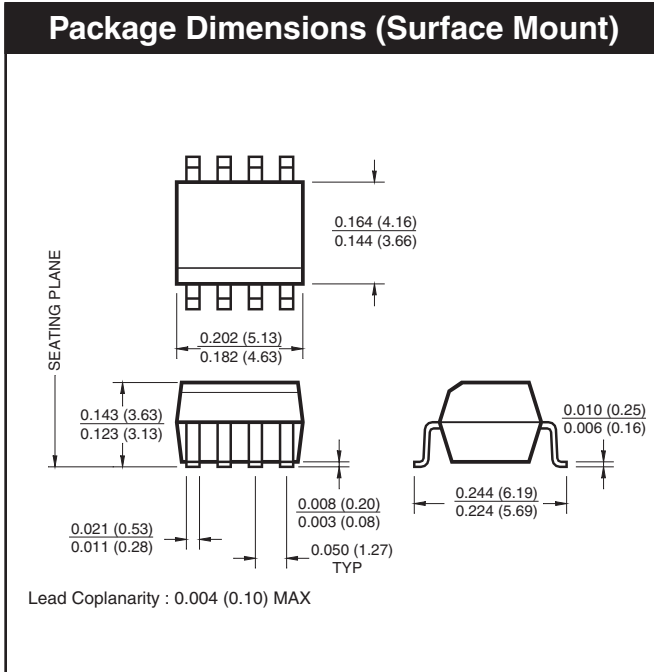

Figure 10. Switching Time Test Circuit and Waveforms



**MOC215-M**

**MOC216-M**

**MOC217-M**

**ORDERING INFORMATION**

Option	Order Entry Identifier	Description
V	V	VDE 0084
R1	R1	Tape and reel (500 units per reel)
R1V	R1V	VDE 0884, Tape and reel (500 units per reel)
R2	R2	Tape and reel (2500 units per reel)
R2V	R2V	VDE 0884, Tape and reel (2500 units per reel)

**MARKING INFORMATION**

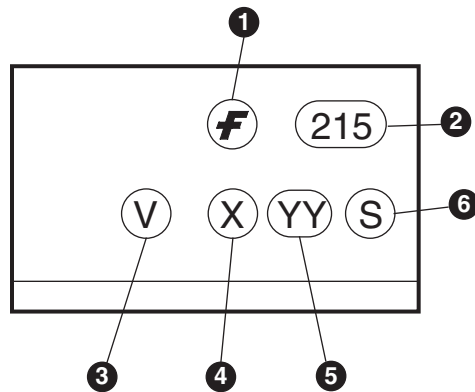

Definitions	
1	Fairchild logo
2	Device number
3	VDE mark (Note: Only appears on parts ordered with VDE option – See order entry table)
4	One digit year code, e.g., '3'
5	Two digit work week ranging from '01' to '53'
6	Assembly package code

**MOC215-M**

**MOC216-M**

**MOC217-M**

**Carrier Tape Specifications**

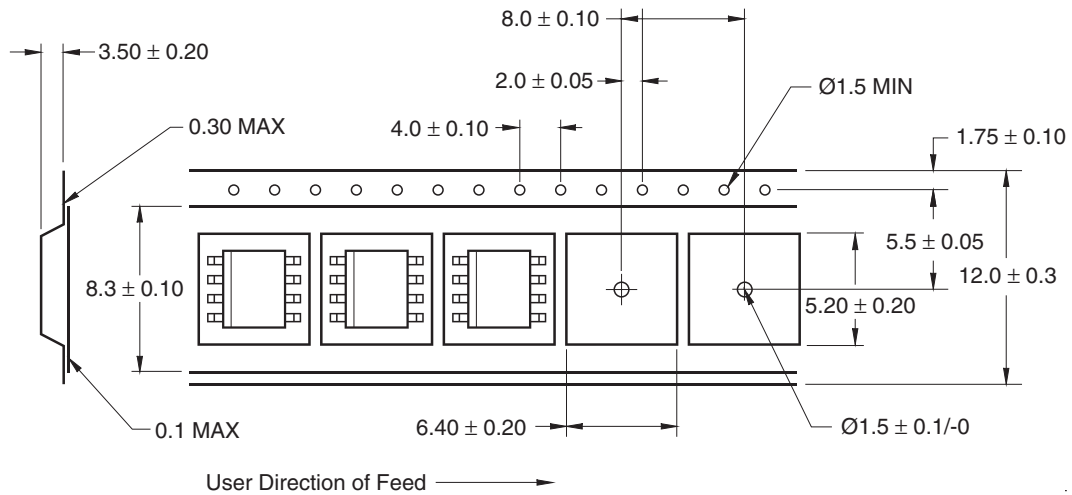

**Reflow Profile**

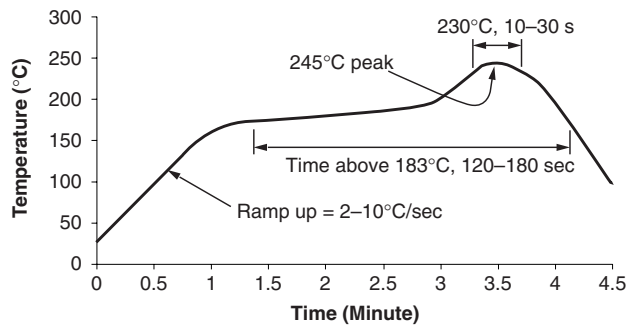

- Peak reflow temperature: 245°C (package surface temperature)
- Time of temperature higher than 183°C for 120-180 seconds
- One time soldering reflow is recommended



---

**MOC215-M**

**MOC216-M**

**MOC217-M**

---

**DISCLAIMER**

FAIRCHILD SEMICONDUCTOR RESERVES THE RIGHT TO MAKE CHANGES WITHOUT FURTHER NOTICE TO ANY PRODUCTS HEREIN TO IMPROVE RELIABILITY, FUNCTION OR DESIGN. FAIRCHILD DOES NOT ASSUME ANY LIABILITY ARISING OUT OF THE APPLICATION OR USE OF ANY PRODUCT OR CIRCUIT DESCRIBED HEREIN; NEITHER DOES IT CONVEY ANY LICENSE UNDER ITS PATENT RIGHTS, NOR THE RIGHTS OF OTHERS.

**LIFE SUPPORT POLICY**

FAIRCHILD'S PRODUCTS ARE NOT AUTHORIZED FOR USE AS CRITICAL COMPONENTS IN LIFE SUPPORT DEVICES OR SYSTEMS WITHOUT THE EXPRESS WRITTEN APPROVAL OF THE PRESIDENT OF FAIRCHILD SEMICONDUCTOR CORPORATION. As used herein:

1. Life support devices or systems are devices or systems which, (a) are intended for surgical implant into the body, or (b) support or sustain life, and (c) whose failure to perform when properly used in accordance with instructions for use provided in the labeling, can be reasonably expected to result in a significant injury of the user.
2. A critical component in any component of a life support device or system whose failure to perform can be reasonably expected to cause the failure of the life support device or system, or to affect its safety or effectiveness.