

TA7616P

T-77-05-05

CAR RADIO AM TUNER ONE CHIP AM SYSTEM

- . Stable Operation at High Input Signal .
- . Wide Operating Supply Voltage Range:
VCC=7~15V, Recommend VCC=9V
- . Small Noise at Detune.
- . AM RF, AM MIX. and AM OSC Amplifiers.
- . AM IF, Detector and AGC Circuits.

MAXIMUM RATINGS (Ta=25°C)

CHARACTERISTIC	SYMBOL	RATING	UNIT
Supply Voltage	VCC	16	V
Power Dissipation (Note)	P _D	750	mW
Operating Temperature	T _{opr}	-30 ~ 75	°C
Storage Temperature	T _{stg}	-55 ~ 150	°C

Note: Derated above Ta=25°C in the proportion of 6mW/°C.

Unit in mm

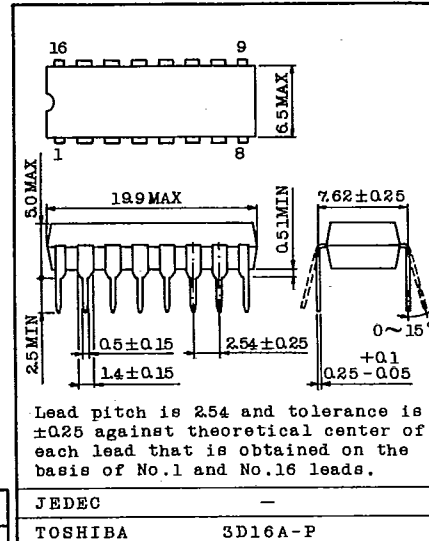

BLOCK AND TERMINAL DIAGRAMS

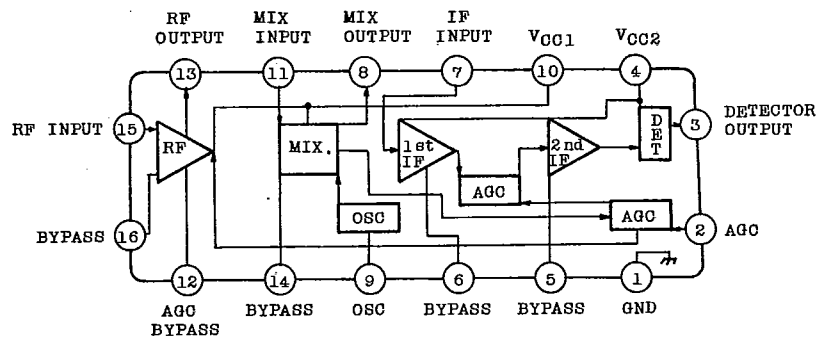

AUDIO LINEAR IC

ELECTRICAL CHARACTERISTICS

(Unless otherwise specified, $V_{CC}=9V$, $f_S=1MHz$, $f_M=400Hz$, $Mod=30%$, $f_{IF}=455kHz$, $T_a=25^{\circ}C$)

CHARACTERISTIC		SYMBOL	TEST CIR-CUIT	TEST CONDITION	MIN.	TYP.	MAX.	UNIT	
Supply Current		I_{CC}	1	-	9	13	20	mA	
Recovered Output Voltage		V_{OD}	1	$V_{IN}=74dB\mu V$	55	84	110	mV_{RMS}	
Maximum Sensitivity		MS	1	$V_{OD}=20mV_{RMS}$	-	9	-	$dB\mu V$	
Quieting Sensitivity		QS	1	$S/N=20dB$	-	24	30	$dB\mu V$	
Signal to Noise Ratio		S/N	1	$V_{IN}=74dB\mu V$	46	52.5	-	dB	
Total Harmonic Distortion		THD(1)	1	$V_{IN}=74dB\mu V$	-	0.3	3	%	
		THD(2)	1	$V_{IN}=74dB\mu V$ Mod=80%	-	0.6	-		
		THD(3)	1	$V_{IN}=120dB\mu V$	-	0.5	-		
Tweet		Tweet	1	$V_{IN}=74dB\mu V$	2IF	-	-35	-	dB
				Max. Point	3IF	-	-40	-	
Pin 15 Input Impedance	Parallel Input Resistance	R_{ip15}	2	$f=1000kHz$	-	6.6	-	$k\Omega$	
	Parallel Input Capacitance	C_{ip15}			-	3	-	pF	
Pin 13 Output Impedance	Parallel Output Resistance	R_{op13}	3	$f=1000kHz$	-	100	-	$k\Omega$	
	Parallel Output Capacitance	C_{op13}			-	1.4	-	pF	
Pin 11 Input Impedance	Parallel Input Resistance	R_{ip11}	4	$f=1000kHz$	-	2.2	-	$k\Omega$	
	Parallel Input Capacitance	C_{ip11}			-	7.5	-	pF	
Pin 8 Output Impedance	Parallel Output Resistance	R_{op8}	5	$f=455kHz$	-	100	-	$k\Omega$	
	Parallel Output Capacitance	C_{op8}			-	3.5	-	pF	
Pin 7 Input Impedance	Parallel Input Resistance	R_{ip7}	6	$f=455kHz$	-	3.5	-	$k\Omega$	
	Parallel Input Capacitance	C_{ip7}			-	8	-	pF	

TA7616P

T-77-05-05

TEST CIRCUIT

1. I_{CC} , V_{OD} , MS, QS, S/N, THD, Tweet

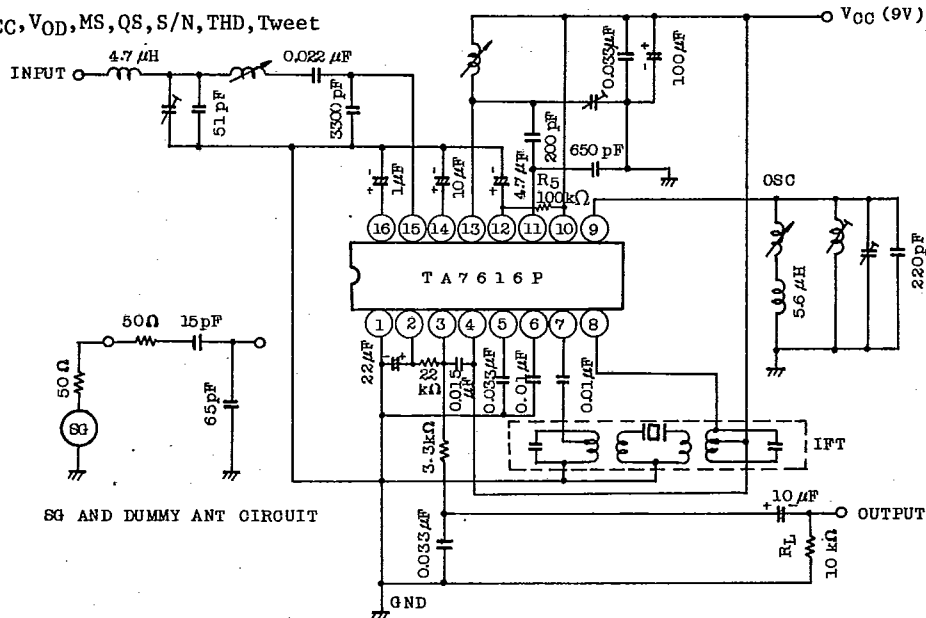

COIL DATA

1. OSC COIL "L"

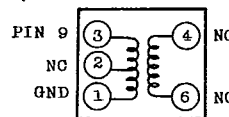

L = 220 μH STANDARD		
Q ≥ 80 at 796 kHz		
① ~ ② 10 T	① ~ ③ 98 T	④ ~ ⑥ 39 T

DENKEN Co., 4691 OR EQUIVALENT

2. IFT

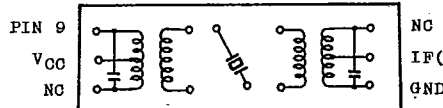

TOKO Co.,
CFT-455A OR EQUIVALENT IFT
LF (PIN 7) CENTER FREQUENCY 455 ± 3.5 kHz

3. AM TUNNER COIL

MITSUMI Co., CMM ZT-02 OR EQUIVALENT TUNNER COIL.
TUNING FREQUENCY RANGE $520 \sim 1660 \pm 40$ kHz

BOTTOM VIEW

AUDIO LINEAR IC

TA7616P

T-77-05-05

2. R_{ip15}, C_{ip15}

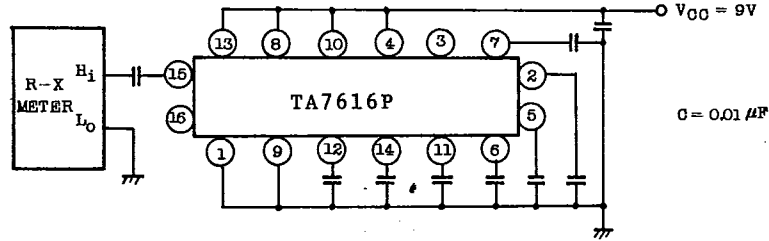

3. R_{op13}, C_{op13}

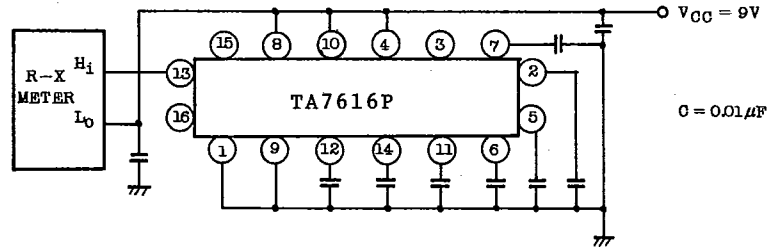

4. R_{ip11}, C_{ip11}

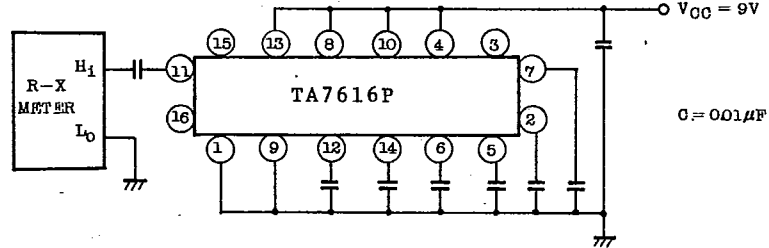

5. R_{op8}, C_{op8}

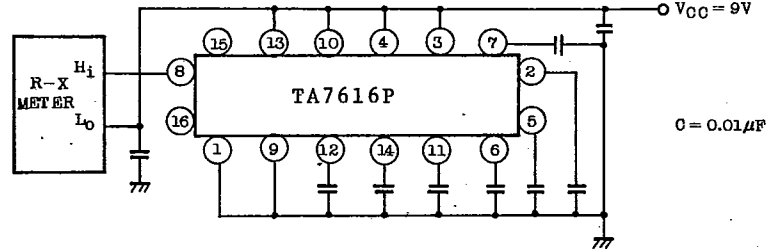

6. R_{ip7}, C_{ip7}

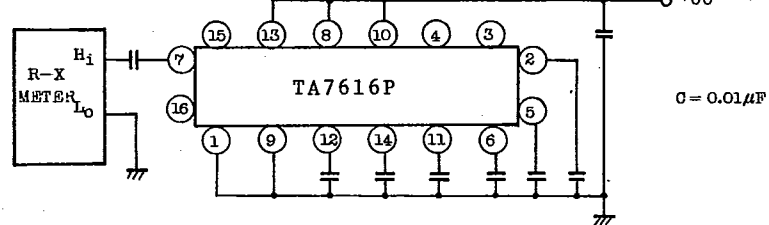

TOSHIBA

TA7616P

T-77-05-05

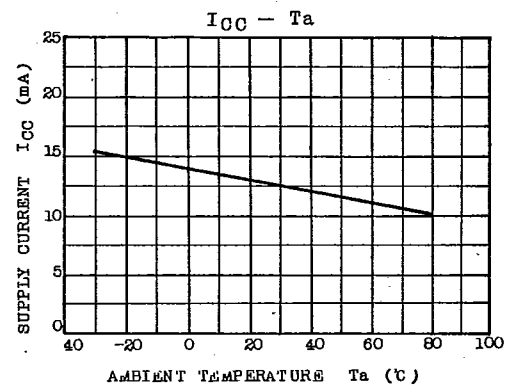
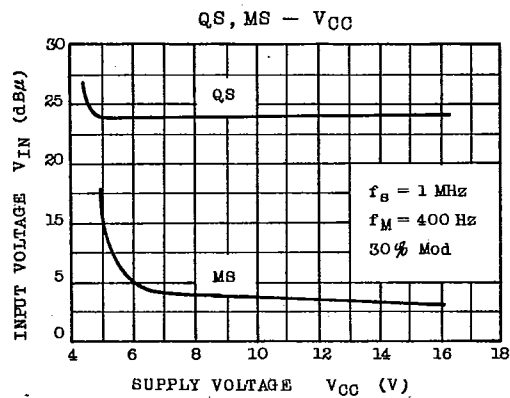
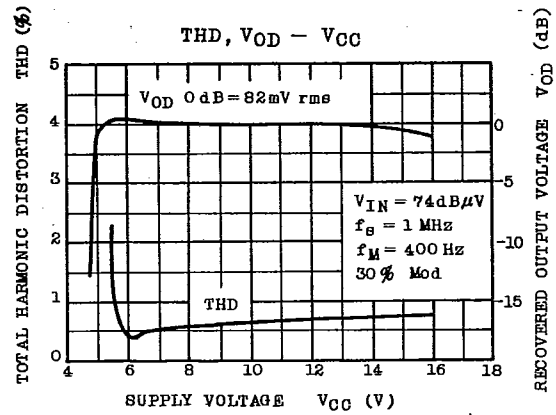
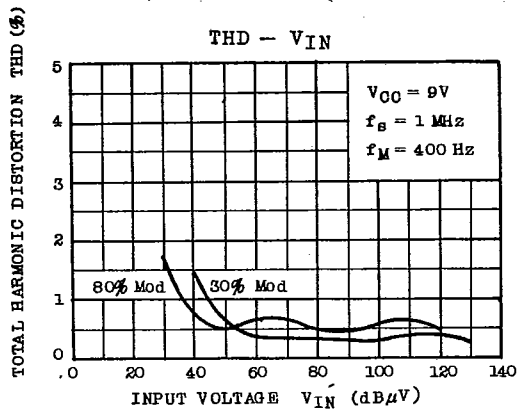
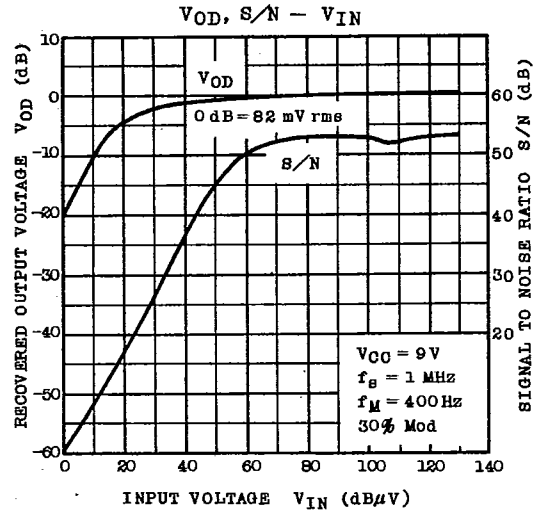
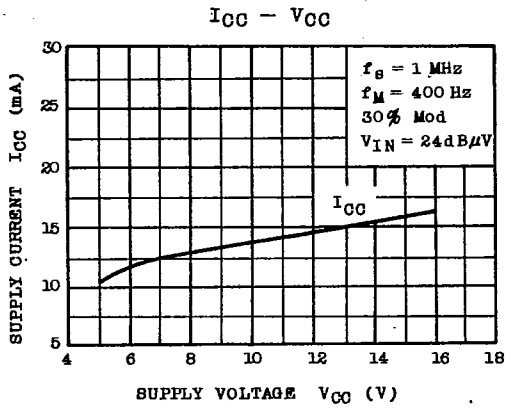

AUDIO LINEAR IC

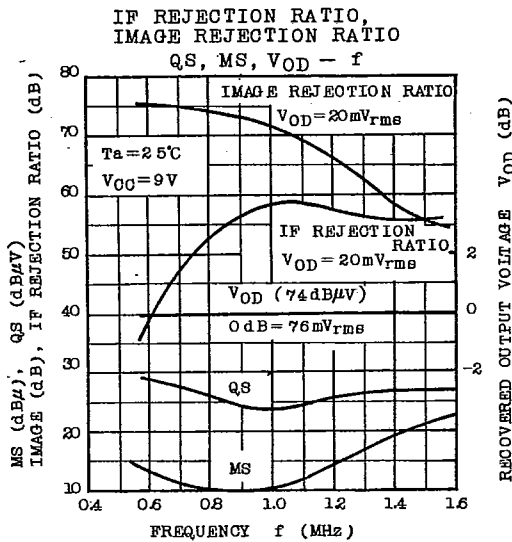
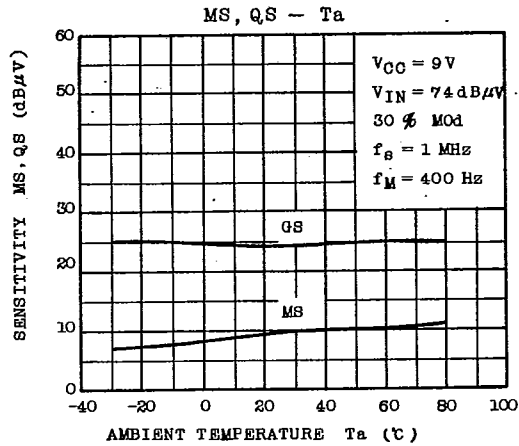
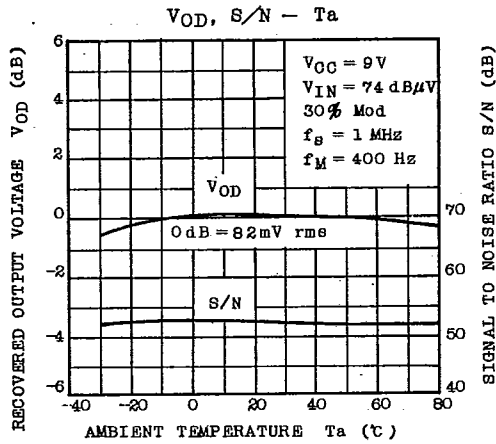

2 SIGNAL CHARACTERISTIC -3dB SIGNAL SUPPRESSION EFFECT

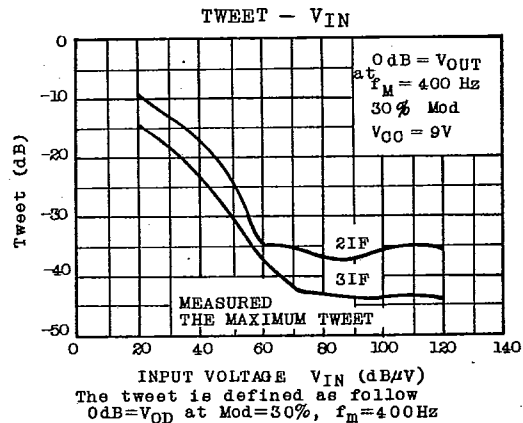
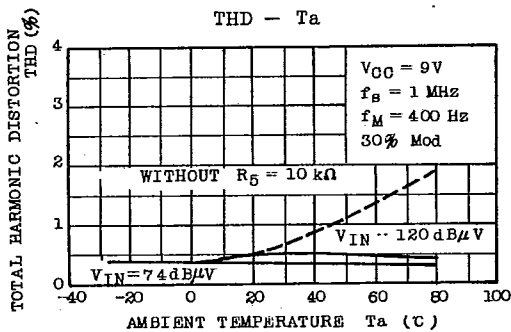
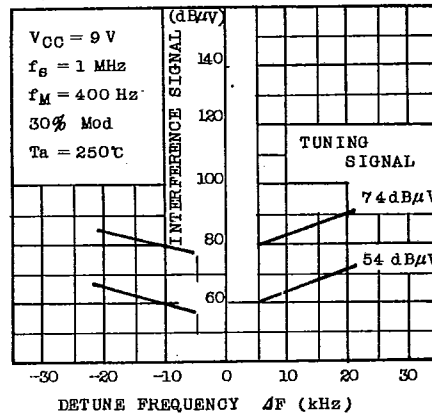

TA7616P

T-77-05-05

APPLICATION CIRCUIT

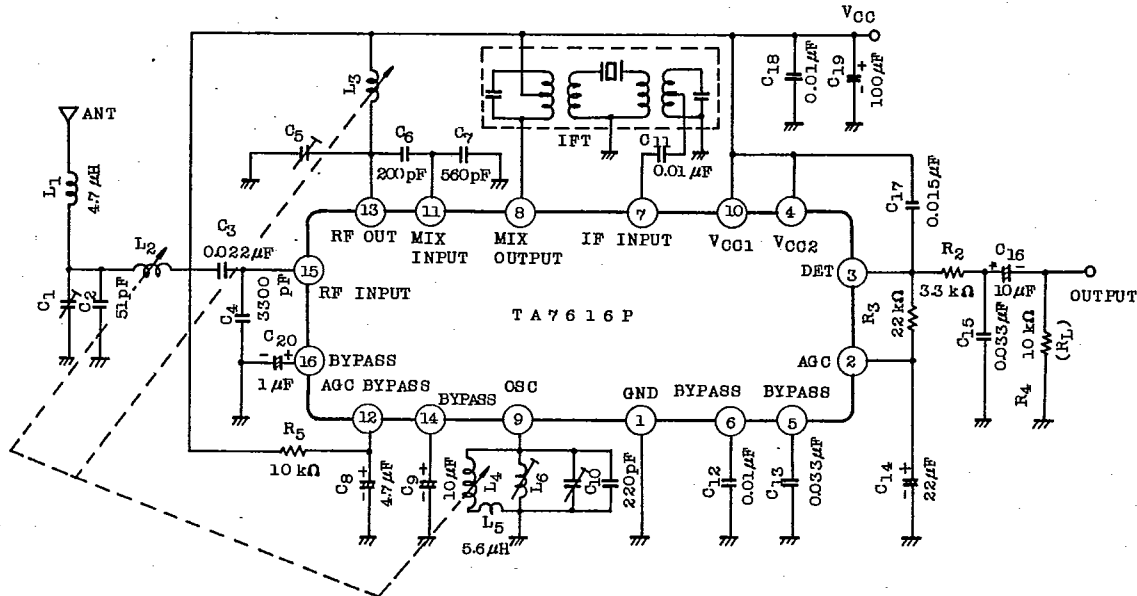

(NOTE) IFT : TOKO OFT-455A

NOTE :

1. To avoid the instability (especially tweet problem), capacitor C₁₇ must be placed near by 3 pin and 4 pin.
2. Inductor L₁ is the noise radiation suppressor from antenna.
3. Capacitor C₆ and C₇ must be selected so that the injection level of the mixer stage will be optimum value.
4. AGC by-passing capacitor C₁₄ and C₈ determine AGC response speed.
So, large value will cause slow response and too small value will cause poor distortion characteristics at low frequency.
5. Resistor R₅ assures low distortion characteristics (THD = 1%) at all operation temperature range.

AUDIO LINEAR IC