

## DUAL FULL-BRIDGE PWM MOTOR DRIVER

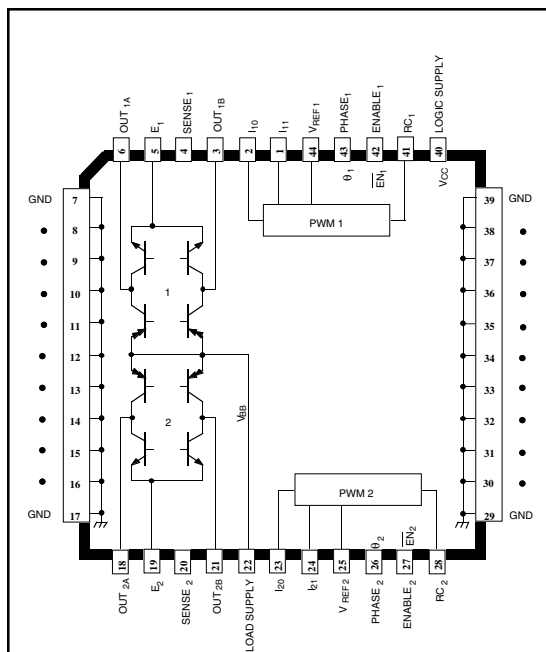

Dwg. PP-021

### ABSOLUTE MAXIMUM RATINGS at $T_j \leq +150^\circ\text{C}$

Motor Supply Voltage, $V_{BB}$ .....	<b>45 V</b>
Output Current, $I_{OUT}$ ( $t_w \leq 20 \mu\text{s}$ ) .....	<b><math>\pm 1.75 \text{ A}</math></b>
(Continuous) .....	<b><math>\pm 1.5 \text{ A}</math></b>
Logic Supply Voltage, $V_{CC}$ .....	<b>7.0 V</b>
Logic Input Voltage Range, $V_{IN}$ .....	<b>-0.3 V to +7.0 V</b>
Output Emitter Voltage, $V_E$ .....	<b>1.0 V</b>
Package Power Dissipation, $P_D$ .....	<b>See Graph</b>
Operating Temperature Range, $T_A$ .....	<b>-20°C to +85°C</b>
Storage Temperature Range, $T_S$ .....	<b>-55°C to +150°C</b>

Output current rating may be limited by duty cycle, ambient temperature, and heat sinking. Under any set of conditions, do not exceed the specified peak current rating or a junction temperature of +150°C.

The UDN2917EB motor driver is designed to drive both windings of a bipolar stepper motor or bidirectionally control two dc motors. Both bridges are capable of sustaining 45 V and include internal pulse-width modulation (PWM) control of the output current to 1.5 A.

For PWM current control, the maximum output current is determined by the user's selection of a reference voltage and sensing resistor. Two logic-level inputs select output current limits of 0, 33%, 67%, or 100% of the maximum level. A PHASE input to each bridge determines load current direction. Active-low ENABLE inputs control the four drivers in each bridge.

The bridges include both ground clamp and flyback diodes for protection against inductive transients. Internally generated delays prevent cross-over currents when switching current direction. Special power-up sequencing is not required. Thermal protection circuitry disables the outputs if the chip temperature exceeds safe operating limits.

The UDN2917EB is supplied in a 44-lead power PLCC for surface-mount applications. Its batwing construction provides for maximum package power dissipation in the smallest possible construction. The UDN2917EB is available for operation from -40°C to +85°C. To order, change the prefix from 'UDN' to 'UDQ'. This device is also available on special order for operation to +125°C.

### FEATURES

- 1.5 A Continuous Output Current
- 45 V Output Sustaining Voltage
- Internal Clamp Diodes
- Digital Control of Output Current
- Internal Thermal Shutdown Circuitry
- Similar to Dual PBL3770

Always order by complete part number: **UDN2917EB** .

# 2917 DUAL FULL-BRIDGE PWM MOTOR DRIVER

## PWM CURRENT-CONTROL CIRCUITRY

CHANNEL 1  
PIN NUMBERS  
SHOWN.

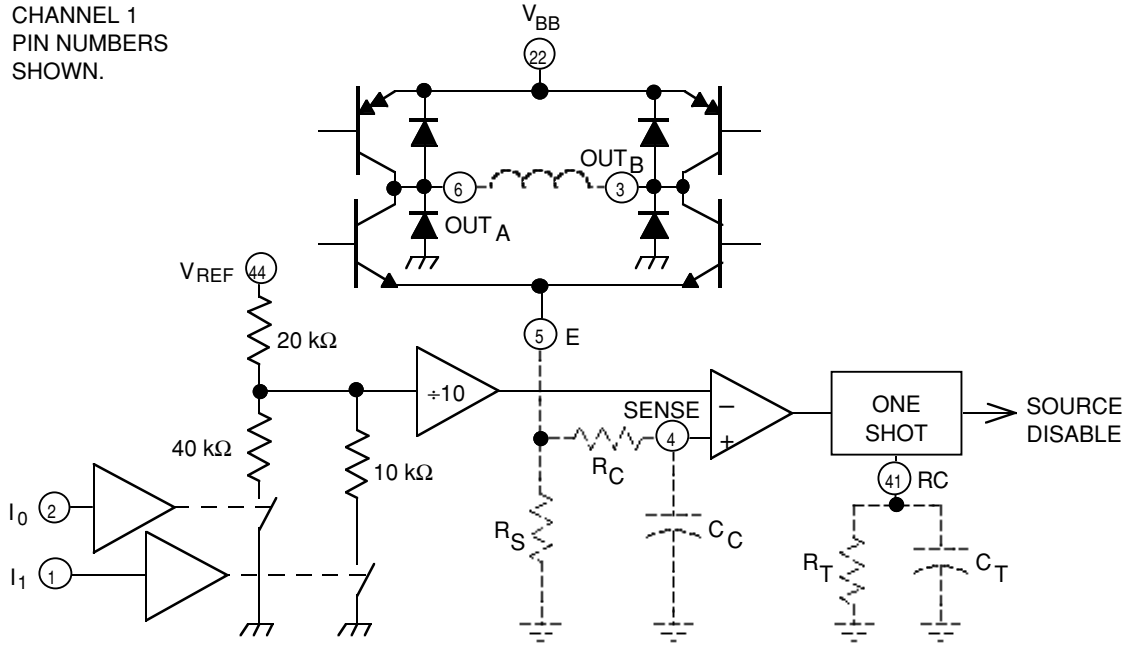

Dwg. EP-007-2A

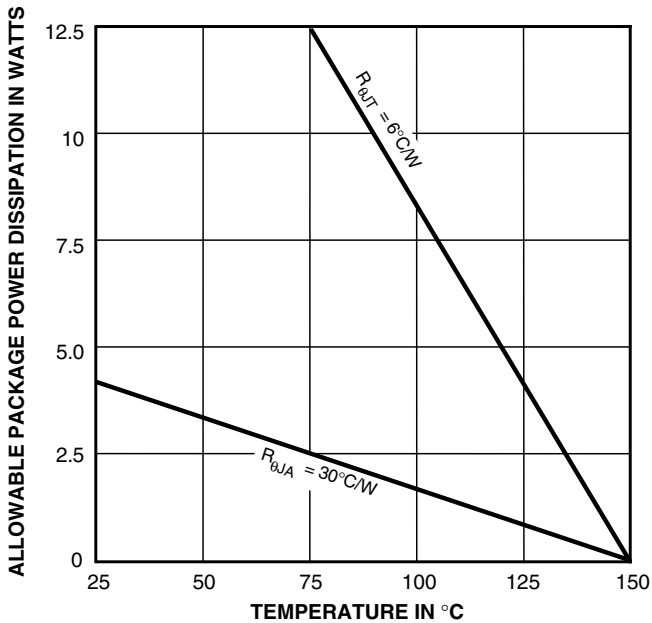

Dwg. GP-020B

## TRUTH TABLE

Enable	Phase	Out <sub>A</sub>	Out <sub>B</sub>
L	H	H	L
L	L	L	H
H	X	Z	Z

X = Don't care  
Z = High impedance

# 2917 DUAL FULL-BRIDGE PWM MOTOR DRIVER

**ELECTRICAL CHARACTERISTICS at  $T_A = +25^\circ\text{C}$ ,  $V_{BB} = 45\text{ V}$ ,  $V_{CC} = 5.0\text{ V}$ ,  $V_{REF} = 5.0\text{ V}$  (unless otherwise noted).**

Characteristic	Symbol	Test Conditions	Limits			Units
			Min.	Typ.	Max.	
<b>Output Drivers (OUT<sub>A</sub> or OUT<sub>B</sub>)</b>						
Motor Supply Range	$V_{BB}$		10	—	45	V
Output Leakage Current	$I_{CEX}$	$V_{OUT} = V_{BB}$	—	<1.0	50	$\mu\text{A}$
		$V_{OUT} = 0$	—	<-1.0	-50	$\mu\text{A}$
Output Sustaining Voltage	$V_{CE(sus)}$	$I_{OUT} = \pm 1.5\text{ A}$ , $L = 3.5\text{ mH}$	45	—	—	V
Output Saturation Voltage	$V_{CE(SAT)}$	Sink Driver, $I_{OUT} = +1.0\text{ A}^*$	—	0.5	0.7	V
		Sink Driver, $I_{OUT} = +1.5\text{ A}^*$	—	0.8	1.0	V
		Source Driver, $I_{OUT} = -1.0\text{ A}^*$	—	1.8	1.9	V
		Source Driver, $I_{OUT} = -1.5\text{ A}^*$	—	1.9	2.1	V
Clamp Diode Leakage Current	$I_R$	$V_R = 45\text{ V}$	—	<1.0	50	$\mu\text{A}$
Clamp Diode Forward Voltage	$V_F$	$I_F = 1.5\text{ A}$	—	1.6	2.0	V
Driver Supply Current	$I_{BB(ON)}$	Both Bridges On, No Load	—	9.0	12	mA
	$I_{BB(OFF)}$	Both Bridges Off	—	4.0	6.0	mA

### Control Logic

Input Voltage	$V_{IN(1)}$	All Inputs	2.4	—	—	V
	$V_{IN(0)}$	All Inputs	—	—	0.8	V
Input Current	$I_{IN(1)}$	$V_{IN} = 2.4\text{ V}$	—	<1.0	20	$\mu\text{A}$
	$I_{IN(0)}$	$V_{IN} = 0.8\text{ V}$	—	-3.0	-200	$\mu\text{A}$
Reference Voltage Range	$V_{REF}$	Operating	1.5	—	7.5	V
Current Limit Threshold (at trip point)	$V_{REF}/V_{SENSE}$	$I_0 = I_1 = 0.8\text{ V}$	9.5	10	10.5	—
		$I_0 = 2.4\text{ V}$ , $I_1 = 0.8\text{ V}$	13.5	15	16.5	—
		$I_0 = 0.8\text{ V}$ , $I_1 = 2.4\text{ V}$	25.5	30	34.5	—
Thermal Shutdown Temp.	$T_J$		—	170	—	$^\circ\text{C}$
Total Logic Supply Current	$I_{CC(ON)}$	$I_0 = I_1 = V_{EN} = 0.8\text{ V}$ , No Load	—	90	105	mA
	$I_{CC(OFF)}$	$I_0 = I_1 = 2.4\text{ V}$ , No Load	—	10	12	mA

Negative current is defined as coming out of (sourcing) the specified device pin.

Typical Data is for design information only.

\* Pulse test (<10 ms).

# 2917 DUAL FULL-BRIDGE PWM MOTOR DRIVER

## APPLICATIONS INFORMATION

### PWM CURRENT CONTROL

The UDN2917EB dual bridge is designed to drive both windings of a bipolar stepper motor. Output current is sensed and controlled independently in each bridge by an external sense resistor ( $R_S$ ), internal comparator, and monostable multivibrator.

When the bridge is turned on, current increases in the motor winding and it is sensed by the external sense resistor until the sense voltage ( $V_{SENSE}$ ) reaches the level set at the comparator's input:

$$I_{TRIP} = V_{REF}/10 R_S$$

The comparator then triggers the monostable which turns off the source driver of the bridge. The actual load current peak will be slightly higher than the trip point (especially for low-inductance loads) because of the internal logic and switching delays. This delay ( $t_d$ ) is typically  $2 \mu s$ . After turn-off, the motor current will normally decay, circulating through the ground clamp diode and sink transistor. The source driver's off time (and therefore the magnitude of the current decrease) is determined by the monostable's external RC timing components, where  $t_{off} = R_T C_T$  within the range of  $20 k\Omega$  to  $100 k\Omega$  and  $200 pF$  to  $500 pF$ .

When the source driver is re-enabled, the winding current (the sense voltage) is again allowed to rise to the comparator's threshold. This cycle repeats itself, maintaining the average motor winding current at the desired level.

Special circuitry has been included to prevent runaway current control when the fixed off time ( $t_{off}$ ) is set too short. This circuitry prevents the source driver from being re-enabled until the load current has decayed to below the  $I_{TRIP}$  level.

### PWM OUTPUT CURRENT WAVEFORM

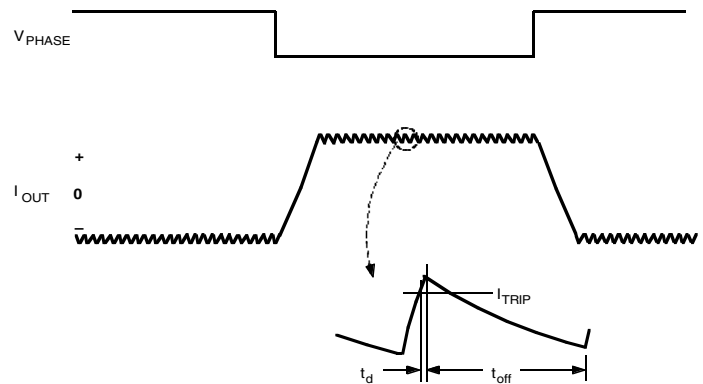

Dwg. WM-003-1A

### LOAD CURRENT PATHS

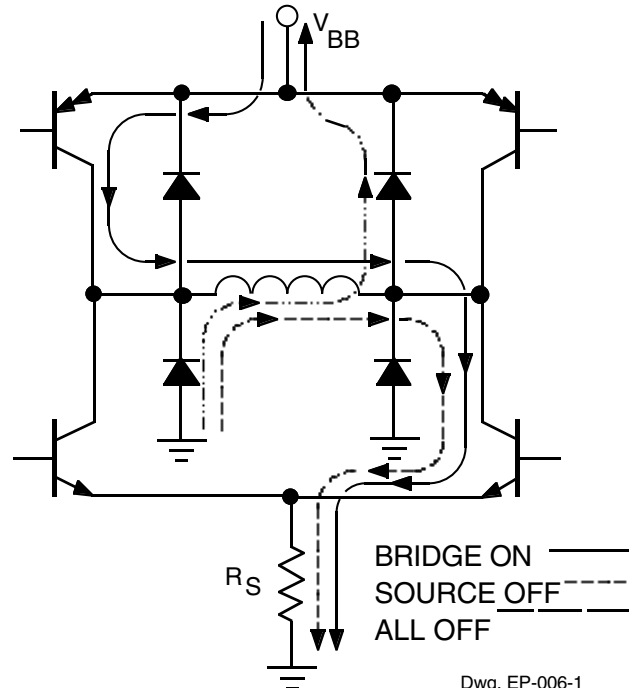

Dwg. EP-006-1

# 2917

## **DUAL FULL-BRIDGE PWM MOTOR DRIVER**

### CURRENT-CONTROL TRUTH TABLE

$I_0$	$I_1$	Output Current
L	L	$V_{REF}/10 R_S = I_{TRIP}$
H	L	$V_{REF}/15 R_S = 2/3 I_{TRIP}$
L	H	$V_{REF}/30 R_S = 1/3 I_{TRIP}$
H	H	0

Loads with high distributed capacitances may result in high turn-on current peaks. This peak (appearing across  $R_S$ ) will attempt to trip the comparator, resulting in erroneous current control or high-frequency oscillations. An external  $R_C C_C$  low-pass filter may be needed to delay the action of the comparator.

#### LOGIC CONTROL OF OUTPUT CURRENT

Two logic level inputs ( $I_0$  and  $I_1$ ) allow digital selection of the motor winding current at 100%, 67%, 33%, or 0% of the maximum level per the table. The 0% output current condition turns off all drivers in the bridge and can be used as an output enable function. These logic level inputs greatly enhance the implementation of  $\mu P$ -controlled drive formats.

During half-step operations, the  $I_0$  and  $I_1$  inputs allow the  $\mu P$  to control the motor at a constant torque between all positions in an eight-step sequence. This is accomplished by digitally selecting 100% drive current when only one phase is on and 67% drive current when two phases are on.

The logic control inputs can also be used to select a reduced current level (and reduced power dissipation) for 'hold' conditions and/or increased current (and available torque) for start-up conditions.

#### GENERAL

To avoid excessive voltage spikes on the LOAD SUPPLY pin ( $V_{BB}$ ), a large-value capacitor ( $\geq 47 \mu F$ ) should be connected from  $V_{BB}$  to ground as close as possible to the device. Under no circumstances should the voltage at LOAD SUPPLY exceed 45 V.

The PHASE input to each bridge determines the direction motor winding current flows. An internally generated deadtime (approximately 3  $\mu s$ ) prevents crossover currents that can occur when switching the PHASE input.

All four drivers in the bridge output can be turned off ( $V_{EN} \geq 2.4 V$  or  $I_0 = I_1 \geq 2.4 V$ ), resulting in a fast current decay through the internal output clamp and flyback diodes. The fast current decay is desirable in half-step and high-speed applications. All logic inputs float high; the ENABLE input must be tied low if it is not used.

Varying the reference voltage ( $V_{REF}$ ) provides continuous control of the peak load current for micro-stepping applications, within the specified limits for  $V_{REF}$ .

Thermal protection circuitry turns off all drivers when the junction temperature reaches  $+170^\circ C$ . It is only intended to protect the device from failures due to excessive junction temperature and should not imply that output short circuits are permitted. The output drivers are re-enabled when the junction temperature cools to  $+145^\circ C$ .

# 2917 DUAL FULL-BRIDGE PWM MOTOR DRIVER

## UDN2917EB

Dimensions in Inches  
(controlling dimensions)

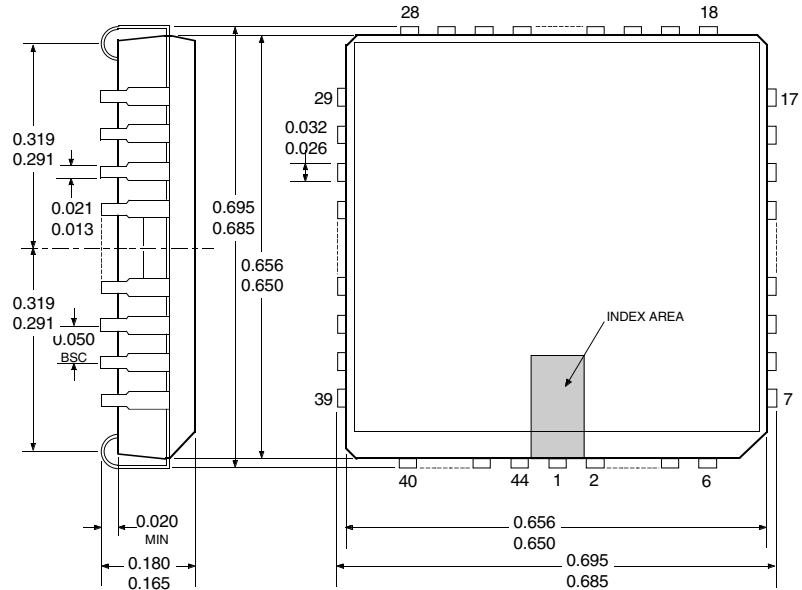

Dwg. MA-005-44A in

Dimensions in Millimeters  
(for reference only)

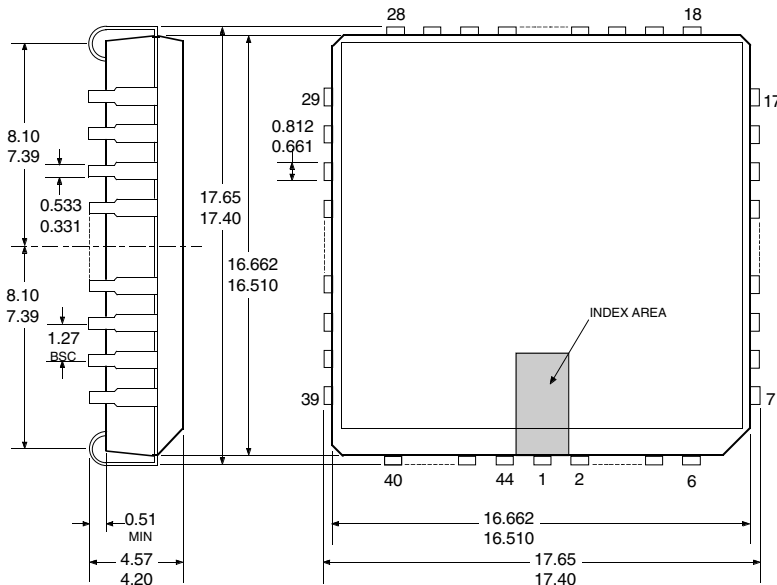

Dwg. MA-005-44A mm

- NOTES:
1. MO-047AC except for terminal shoulder height.
  2. Webbed lead frame. Leads 7-17 and 29-39 are internally one piece.
  3. Lead spacing tolerance is non-cumulative.
  4. Exact body and lead configuration at vendor's option within limits shown.
  5. Supplied in standard sticks/tubes of 27 devices or add "TR" to part number for tape and reel.



115 Northeast Cutoff, Box 15036  
Worcester, Massachusetts 01615-0036 (508) 853-5000

**2917**  
**DUAL FULL-BRIDGE**  
**PWM MOTOR DRIVER**

*The products described here are manufactured under one or more U.S. patents or U.S. patents pending.*

*Allegro MicroSystems, Inc. reserves the right to make, from time to time, such departures from the detail specifications as may be required to permit improvements in the performance, reliability, or manufacturability of its products. Before placing an order, the user is cautioned to verify that the information being relied upon is current.*

*Allegro products are not authorized for use as critical components in life-support devices or systems without express written approval.*

*The information included herein is believed to be accurate and reliable. However, Allegro MicroSystems, Inc. assumes no responsibility for its use; nor for any infringement of patents or other rights of third parties which may result from its use.*

**2917**  
**DUAL FULL-BRIDGE**  
**PWM MOTOR DRIVER**

**MOTOR DRIVERS**

Function	Output Ratings*		Part Number†
<b>INTEGRATED CIRCUITS FOR BRUSHLESS DC MOTORS</b>			
3-Phase Power MOSFET Controller	—	28 V	3933
3-Phase Power MOSFET Controller	—	50 V	3932
3-Phase Power MOSFET Controller	—	50 V	7600
2-Phase Hall-Effect Sensor/Driver	400 mA	26 V	3626
Bidirectional 3-Phase Back-EMF Controller/Driver	±600 mA	14 V	8906
2-Phase Hall-Effect Sensor/Driver	900 mA	14 V	3625
3-Phase Back-EMF Controller/Driver	±900 mA	14 V	8902–A
3-Phase Controller/Drivers	±2.0 A	45 V	2936 & 2936-120
<b>INTEGRATED BRIDGE DRIVERS FOR DC AND BIPOLAR STEPPER MOTORS</b>			
Dual Full Bridge with Protection & Diagnostics	±500 mA	30 V	3976
PWM Current-Controlled Dual Full Bridge	±650 mA	30 V	3966
PWM Current-Controlled Dual Full Bridge	±650 mA	30 V	3968
PWM Current-Controlled Dual Full Bridge	±750 mA	45 V	2916
PWM Current-Controlled Dual Full Bridge	±750 mA	45 V	2919
PWM Current-Controlled Dual Full Bridge	±750 mA	45 V	6219
PWM Current-Controlled Dual Full Bridge	±800 mA	33 V	3964
PWM Current-Controlled Full Bridge	±1.3 A	50 V	3953
PWM Current-Controlled Dual Full Bridge	±1.5 A	45 V	2917
PWM Current-Controlled Microstepping Full Bridge	±1.5 A	50 V	3955
PWM Current-Controlled Microstepping Full Bridge	±1.5 A	50 V	3957
PWM Current-Controlled Dual DMOS Full Bridge	±1.5 A	50 V	3972
Dual Full-Bridge Driver	±2.0 A	50 V	2998
PWM Current-Controlled Full Bridge	±2.0 A	50 V	3952
DMOS Full Bridge PWM Driver	±2.0 A	50 V	3958
Dual DMOS Full Bridge	±2.5 A	50 V	3971
<b>UNIPOLAR STEPPER MOTOR &amp; OTHER DRIVERS</b>			
Voice-Coil Motor Driver	±500 mA	6 V	8932–A
Voice-Coil Motor Driver	±800 mA	16 V	8958
Unipolar Stepper-Motor Quad Drivers	1 A	46 V	7024 & 7029
Unipolar Microstepper-Motor Quad Driver	1.2 A	46 V	7042
Unipolar Stepper-Motor Translator/Driver	1.25 A	50 V	5804
Unipolar Stepper-Motor Quad Driver	1.8 A	50 V	2540
Unipolar Stepper-Motor Quad Driver	1.8 A	50 V	2544
Unipolar Stepper-Motor Quad Driver	3 A	46 V	7026
Unipolar Microstepper-Motor Quad Driver	3 A	46 V	7044

\* Current is maximum specified test condition, voltage is maximum rating. See specification for sustaining voltage limits or over-current protection voltage limits. Negative current is defined as coming out of (sourcing) the output.

† Complete part number includes additional characters to indicate operating temperature range and package style.

Also, see 3175, 3177, 3235, and 3275 Hall-effect sensors for use with brushless dc motors.

