

IR2125Z

CURRENT LIMITING SINGLE CHANNEL DRIVER

Features

- Floating channel designed for bootstrap operation
Fully operational to +400V
Tolerant to negative transient voltage
dV/dt immune
- Gate drive supply range from 12 to 18V
- Undervoltage lockout
- Current detection and limiting loop to limit driven power transistor current
- Error lead indicates fault conditions and programs shutdown time
- Output in phase with input

Description

The IR2125Z is a high voltage, high speed power MOSFET and IGBT driver with over-current limiting protection circuitry. Proprietary GVIC and latch immune CMOS technologies enable ruggedized minilithic construction. Logic inputs are compatible with standard CMOS or LSTTL outputs. The output driver features a high pulse current buffer stage designed for minimum driver cross-conduction.

Product Summary

V_{OFFSET}	400V max.
I_{O+/-}	1A / 2A
V_{OUT}	12 - 18V
V_{CSth}	230 mv
t_{on/off} (typ.)	150 & 150 ns

The protection circuitry detects over-current in the driven power transistor and limits the gate drive voltage. Cycle by cycle shutdown is programmed by an external capacitor which directly controls the time interval between detection of the over-current limiting conditions and latched shutdown. The floating channel can be used to drive an N-channel power MOSFET or IGBT in the high or low side configuration which operates up to 400 volts.

Absolute Maximum Ratings

Absolute Maximum Ratings indicate sustained limits beyond which damage to the device may occur. All voltage parameters are absolute voltages referenced to COM. The Thermal Resistance and Power Dissipation ratings are measured under board mounted and still air conditions.

Symbol	Parameter	Min.	Max.	Units
V _B	High Side Floating Supply Voltage	-0.3	V _S + 20	V
V _S	High Side Floating Supply Offset Voltage	-5	400	
V _{HO}	High Side Floating Output Voltage	V _S - 0.3	V _B + 0.3	
V _{CC}	Logic Supply Voltage	-0.3	20	
V _{ERR}	Error Signal Voltage	-0.3	V _{CC} + 0.3	
V _{CS}	Current Sense Voltage	V _S - 0.3	V _B + 0.3	
V _{IN}	Logic Input Voltage	-0.3	V _{CC} + 0.3	
dV _S /dt	Allowable Offset Supply Voltage Transient	—	50	V/ns
P _D	Package Power Dissipation @ T _A ≤ +25°C	—	1.0	W
R _{qJA}	Thermal Resistance, Junction to Ambient	—	100	°C/W
T _J	Junction Temperature	-55	125	°C
T _S	Storage Temperature	-55	150	
T _L	Lead Temperature (Soldering, 10 seconds)	—	300	

Recommended Operating Conditions

The Input/Output logic timing diagram is shown in Figure 1. For proper operation the device should be used within the recommended conditions. The V_S offset ratings are tested with all supplies biased at 15V differential.

Symbol	Parameter	Min.	Max.	Units
V_B	High Side Floating Supply Absolute Voltage	$V_S + 12$	$V_S + 18$	V
V_S	High Side Floating Supply Offset Voltage	-5	400	
V_{HO}	High Side Floating Output Voltage	V_S	V_B	
V_{CC}	Low Side Fixed Supply Voltage	12	18	
V_{IN}	Logic Input Voltage	V_{SS}	V_{CC}	
V_{ERR}	Error Signal Voltage	V_{SS}	V_{CC}	
V_{CS}	Current Sense Signal Voltage	V_S	V_B	

Dynamic Electrical Characteristics

V_{BIAS} (V_{CC} , V_B) = 15V, and C_L = 3300 PF and T_a = 25°C unless otherwise specified. The dynamic electrical characteristics are measured using the test circuit shown in Figure 3 through 6.

Symbol	Parameter	$T_j = 25^\circ\text{C}$			$T_j = -55 \text{ to } 125^\circ\text{C}$		Units	Test Conditions
		Min.	Typ.	Max.	Min.	Max.		
t_{on}	Turn-On Propagation Delay	—	150	200	—	270	ns	$V_S = 0\text{V to } 400\text{V}$ $C_L = 3300\text{pf}$
t_{off}	Turn-Off Propagation Delay	—	150	300	—	330		
t_r	Turn-On Rise Time	—	43	60	—	80		
t_f	Turn-Off Fall Time	—	26	35	—	50		
t_{cs}	CS to output shutdown propagation delay	—	0.7	1.2	—	1.4	μs	$V_S = 0\text{V TO } 400\text{V}$ $C_{err} = 270\text{pf}$
t_{sd}	Shutdown Propagation Delay	—	1.7	2.2	—	2.5		
t_{err}	CS to ERR pull-up propagation time	—	9	22	—	25		

Typical Connection

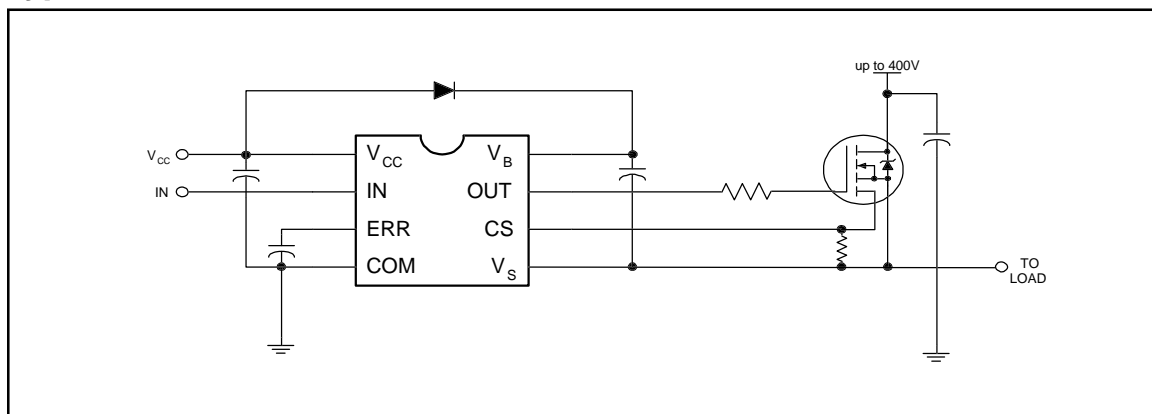

Static Electrical Characteristics

V_{BIAS} (V_{CC}, V_{BS}) = 15V and T_a = 25°C unless otherwise specified. The V_{IN}, V_{TH} and I_{IN} parameters are referenced to COM. V_O and I_O parameters are referenced to V_S.

Symbol	Parameter	T _j = 25°C			T _j = -55 to 125°C		Units	Test Conditions
		Min.	Typ.	Max.	Min.	Max.		
I _{LK}	Offset Supply Leakage Current	—	—	50	—	250	μA	V _B = V _S = 400V
I _{QBS}	Quiescent V _{BS} Supply Current	—	400	1000	—	1300		IN = CS = 0V, or 5V
I _{QCC}	Quiescent V _{CC} Supply Current	—	700	1200	—	1500		IN = CS = 0V, or 5V
I _{IN} ⁺	Logic "1" Input Bias Current	—	4	25	—	30		IN = 5V
I _{IN} ⁻	Logic "0" Input Bias Current	—	—	1.0	—	1.0		IN = 0V
I _{CS} ⁺	"High" CS Bias Current	—	6	15	—	30		CS = 3V
I _{CS} ⁻	"Low" CS Bias Current	—	—	1.0	—	1.0		CS = 0V
V _{IH}	Logic "1" Input Voltage	—	—	—	3.0	—		V
V _{IL}	Logic "0" Input Voltage	—	—	—	—	0.8		
V _{ERR} ⁺	Logic "1" ERR Input Voltage	—	—	—	2.2	—		
V _{ERR} ⁻	Logic "0" ERR Input Voltage	—	—	—	—	0.8		
V _{CS} ^{TH+}	CS Input Positive Going Threshold	150	230	320	—	—	mV	10V < V _{CC} < 20V
V _{CS} ^{TH-}	CS Input Positive Going Threshold	130	200	300	—	—		10V < V _{CC} < 20V
V _{BSUV} ⁺	V _{BS} Supply Overvoltage Positive Going Threshold	8.5	9.3	10	—	—	V	
V _{BSUV} ⁻	V _{BS} Supply Undervoltage Negative Going Threshold	7.7	8.5	9.0	—	—		
V _{BSOV} ⁺	V _{BS} Supply Overvoltage Positive Going Threshold	19.8	21.5	23	—	—		
V _{BSOV} ⁻	V _{BS} Supply Undervoltage Negative Going Threshold	19.1	20.8	22.4	—	—		
V _{CCUV} ⁺	V _{CC} Supply Overvoltage Positive Going Threshold	8.3	8.8	9.6	—	—		
V _{CCUV} ⁻	V _{CC} Supply Undervoltage Negative Going Threshold	7.3	8.1	8.7	—	—		
V _{CCOV} ⁺	V _{CC} Supply Overvoltage Positive Going Threshold	20	21.2	23	—	—		
V _{CCOV} ⁻	V _{CC} Supply Undervoltage Negative Going Threshold	19.3	20.7	22.5	—	—		
I _{ERR}	ERR Timing Charge Current	40	100	130	—	—	μA	IN = 5V, CS = 3V ERR < V _{ERR} ⁺
I _{ERR} ⁺	ERR Pull-up Current	8.0	15	—	—	—	mA	IN = 5V, CS = 3V ERR > V _{ERR} ⁺
I _{ERR} ⁻	ERR Pull-down Current	16	30	—	—	—		IN = 0V
V _{OH}	High Level Output Voltage	V _B -0.1	—	—	V _B -0.1	—	V	IN = 5V, I _O = 0A
V _{OL}	Low Level Output Voltage	—	—	V _S +0.1	—	V _S +0.1		IN = 0V, I _O = 0A
R _{on,ON}	Output High on Resistance	—	9	—	—	—	Ω	
R _{on,OFF}	Output Low on Resistance	—	3	—	—	—		

IR2125Z

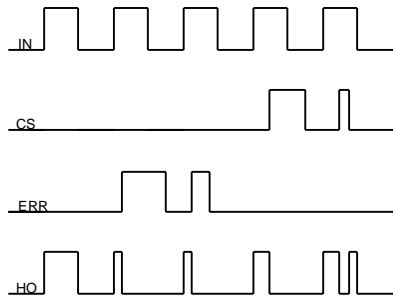

Figure 1. Input/Output Timing Diagram

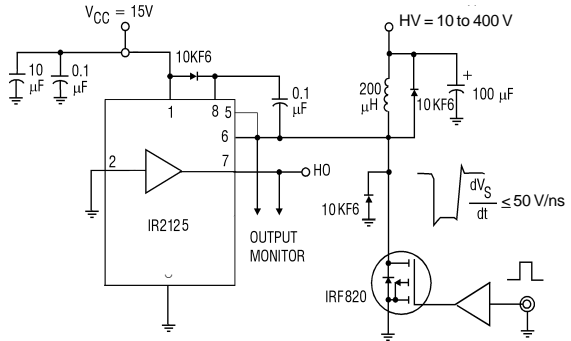

Figure 2. Floating Supply Voltage Transient Test Circuit

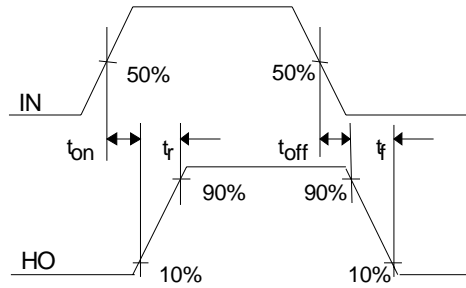

Figure 3. Switching Time Waveform Definitions

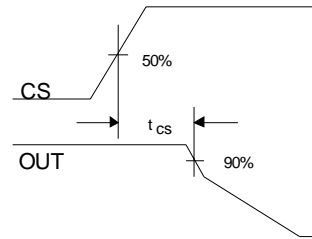

Figure 4. ERR Shutdown Waveform Definitions

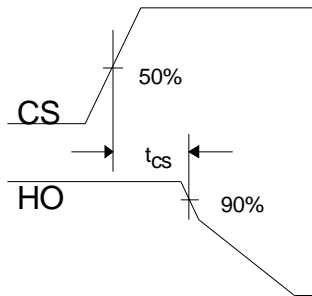

Figure 5. CS Shutdown Waveform Definitions

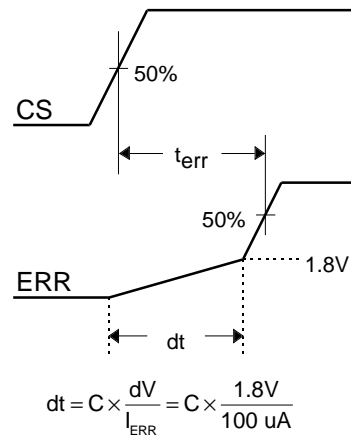

Figure 6. CS to ERR Waveform Definitions

$$dt = C \times \frac{dV}{I_{ERR}} = C \times \frac{1.8V}{100 \mu A}$$

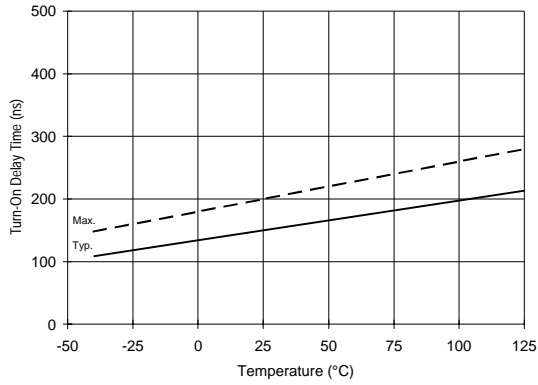

Figure 7A. Turn-On Time vs. Temperature

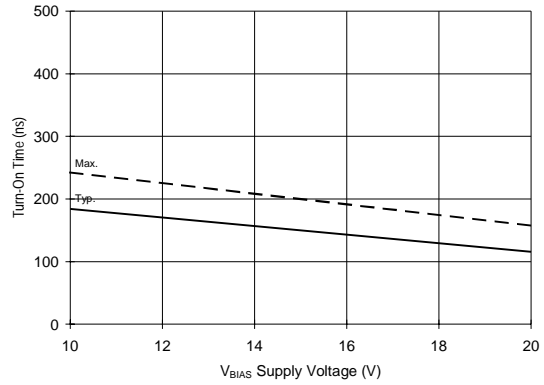

Figure 7B. Turn-On Time vs. Voltage

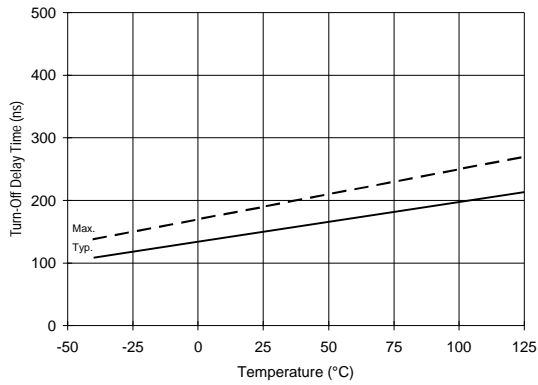

Figure 8A. Turn-Off Time vs. Temperature

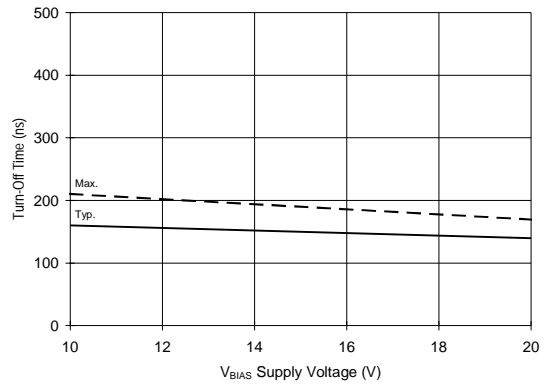

Figure 8B. Turn-Off Time vs. Voltage

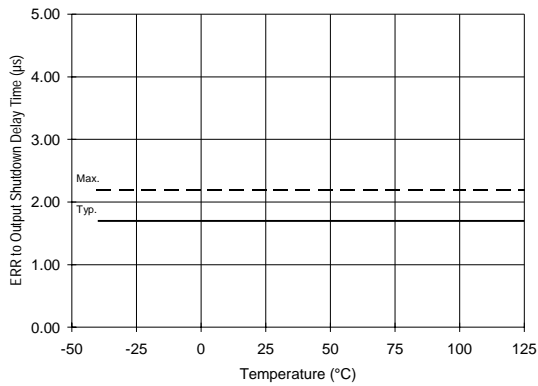

Figure 9A. ERR to Output Shutdown vs. Temperature

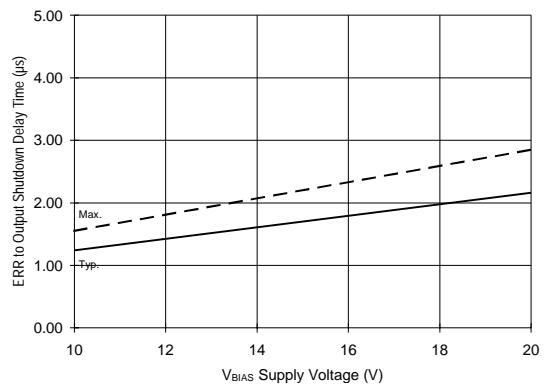

Figure 9B. ERR to Output Shutdown vs. Voltage

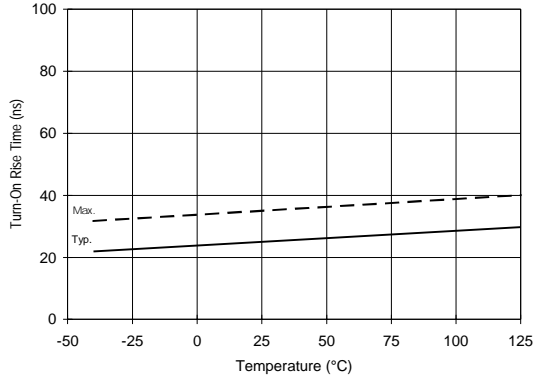

Figure 10A. Turn-On Rise Time vs. Temperature

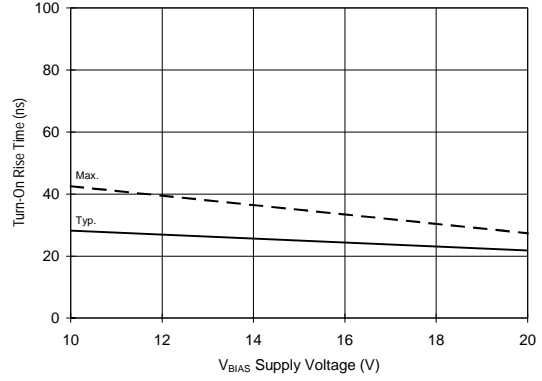

Figure 10B. Turn-On Rise Time vs. Voltage

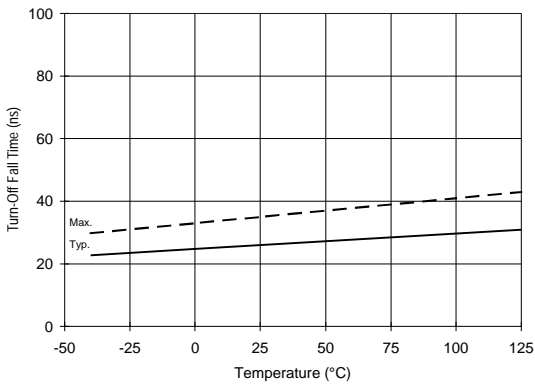

Figure 11A. Turn-Off Fall Time vs. Temperature

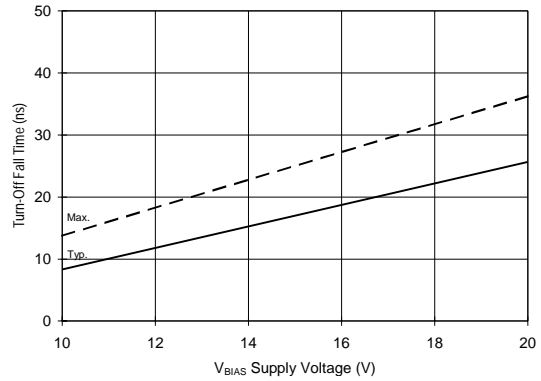

Figure 11B. Turn-Off Fall Time vs. Voltage

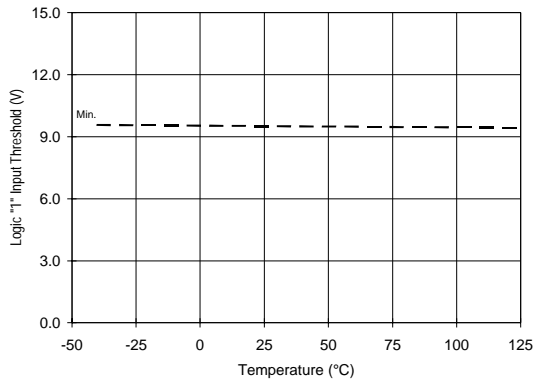

Figure 12A. Logic "1" Input Threshold vs. Temperature

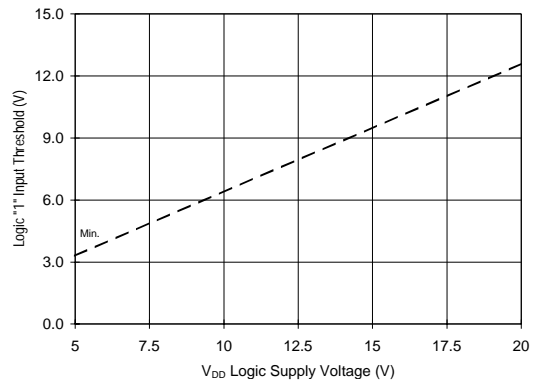

Figure 12B. Logic "1" Input Threshold vs. Voltage

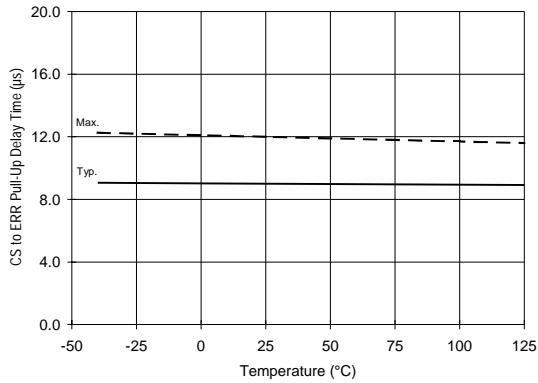

Figure 13A. CS to ERR Pull-Up vs. Temperature

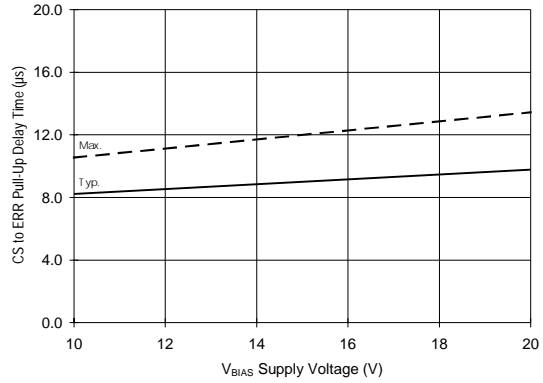

Figure 13B. CS to ERR Pull-Up vs. Voltage

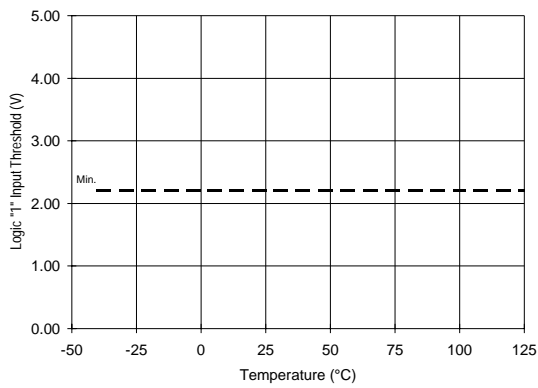

Figure 14A. Logic "1" Input Threshold vs. Temperature

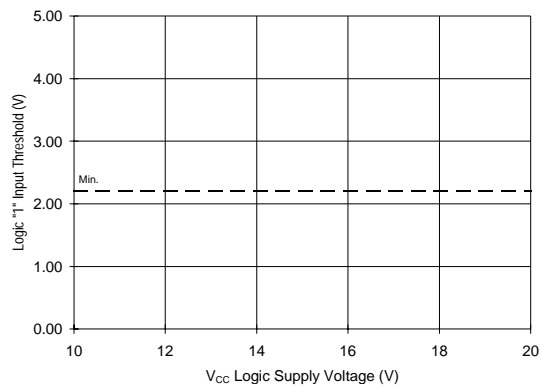

Figure 14B. Logic "1" Input Threshold vs. Voltage

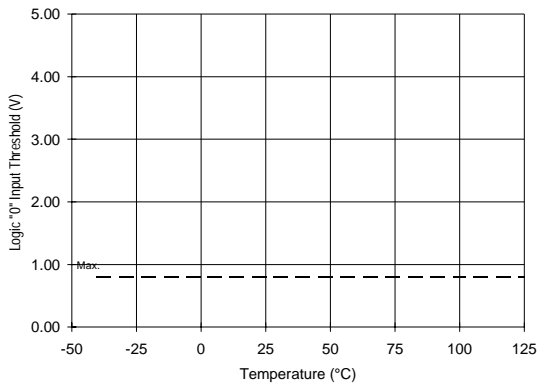

Figure 15A. Logic "0" Input Threshold vs. Temperature

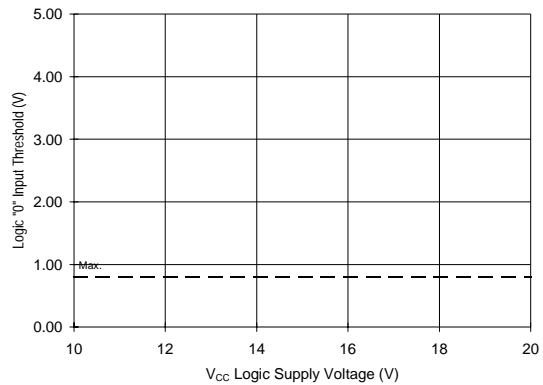

Figure 15B. Logic "0" Input Threshold vs. Voltage

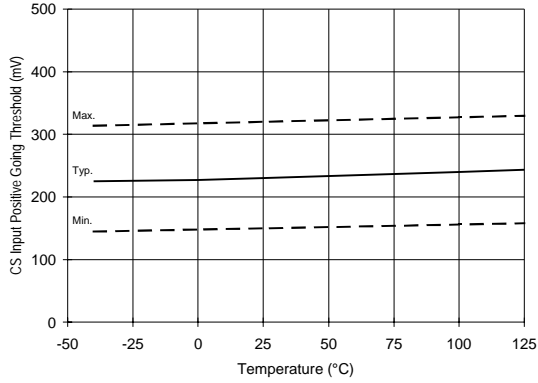

Figure 16A. CS Input Threshold (+) vs. Temperature

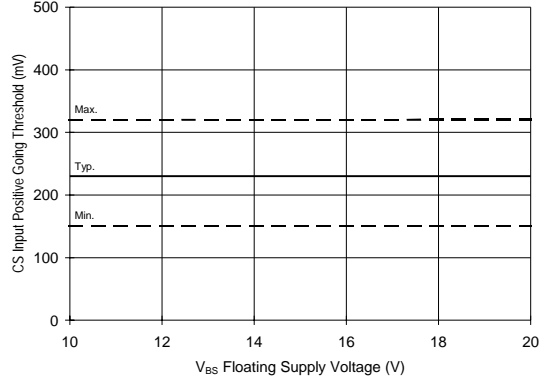

Figure 16B. CS Input Threshold (+) vs. Voltage

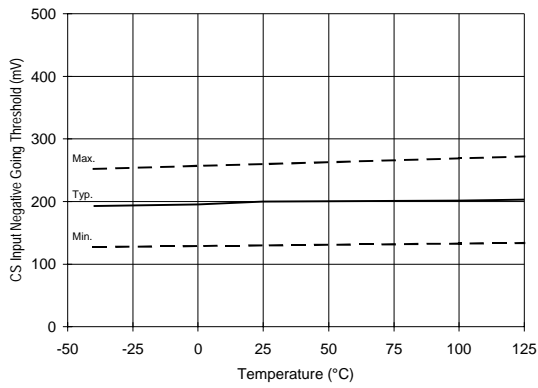

Figure 17A. CS Input Threshold (-) vs. Temperature

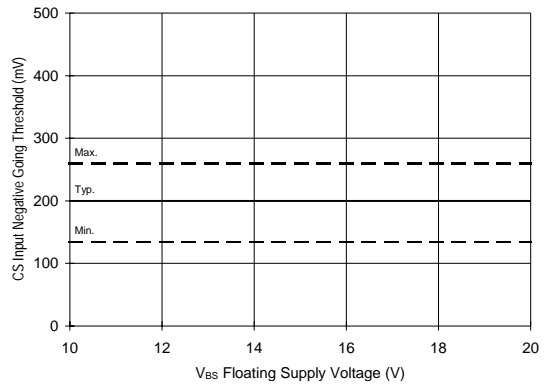

Figure 17B. CS Input Threshold (-) vs. Voltage

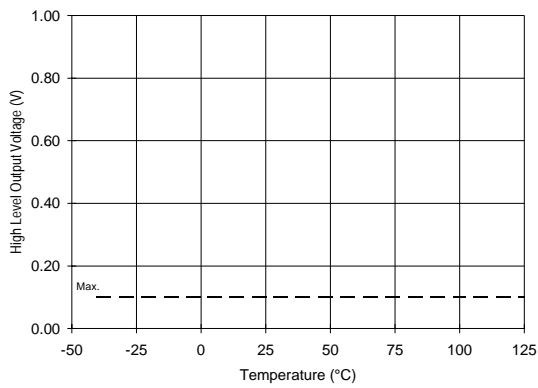

Figure 18A. High Level Output vs. Temperature

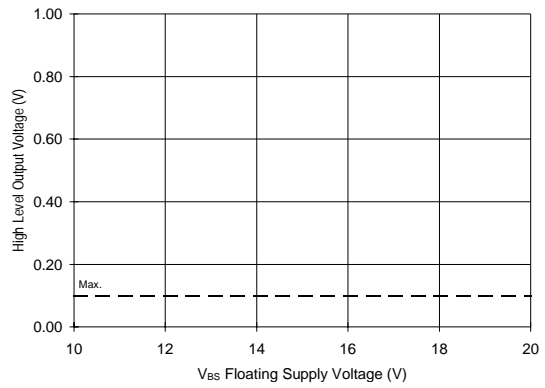

Figure 18B. High Level Output vs. Voltage

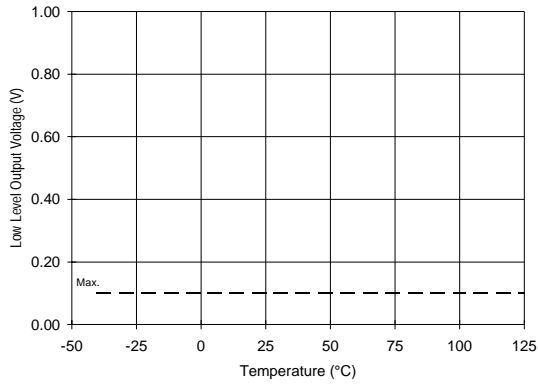

Figure 19A. Low Level Output vs. Temperature

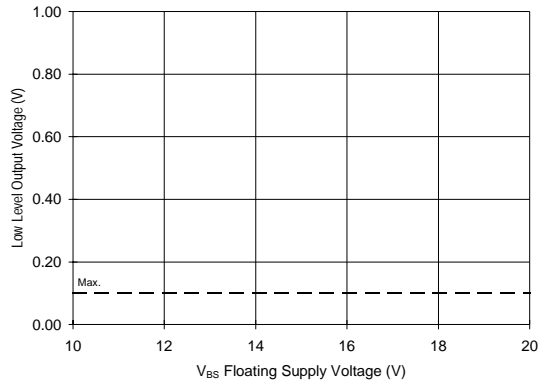

Figure 19B. Low Level Output vs. Voltage

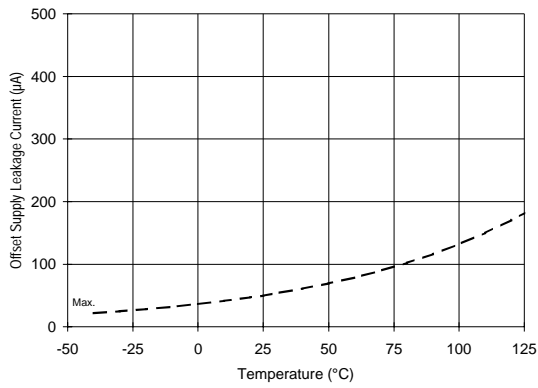

Figure 20A. Offset Supply Current vs. Temperature

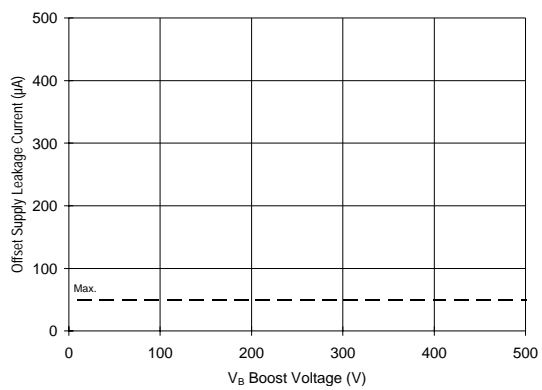

Figure 20B. Offset Supply Current vs. Voltage

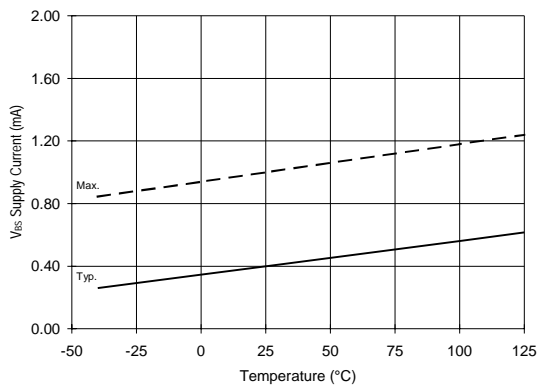

Figure 21A. V_{BS} Supply Current vs. Temperature

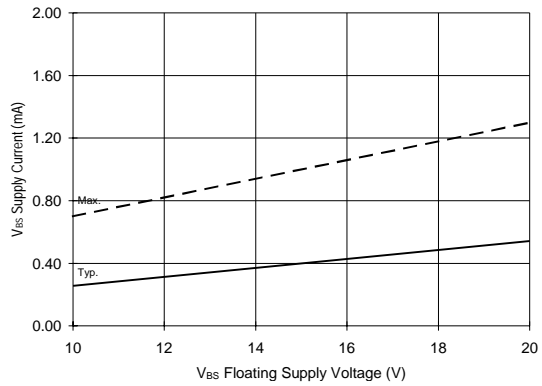

Figure 21B. V_{BS} Supply Current vs. Voltage

IR2125Z

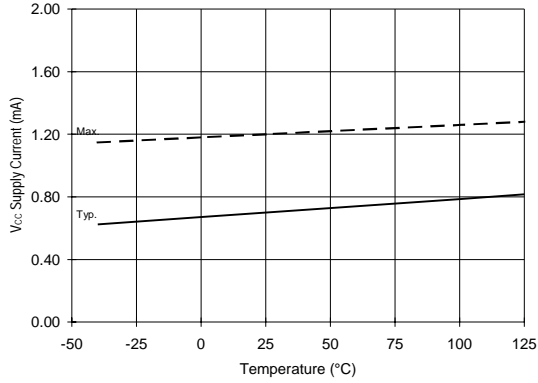

Figure 22A. V_{CC} Supply Current vs. Temperature

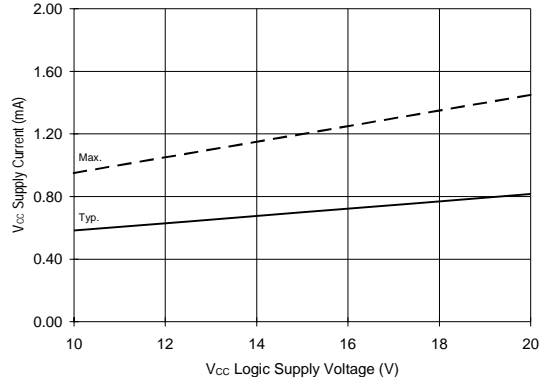

Figure 22B. V_{CC} Supply Current vs. Voltage

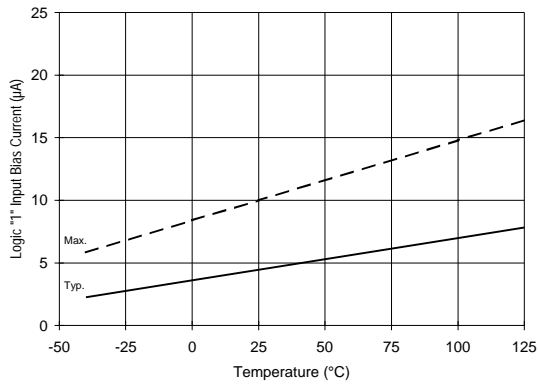

Figure 23A. Logic "1" Input Current vs. Temperature

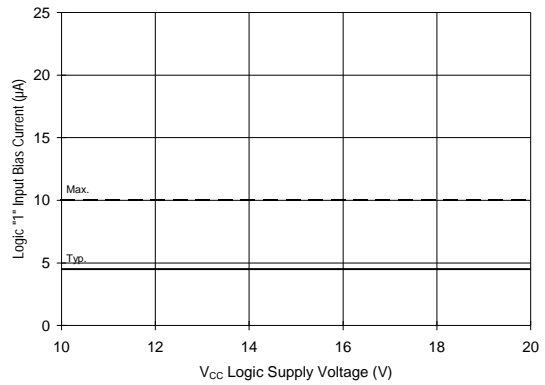

Figure 23B. Logic "1" Input Current vs. Voltage

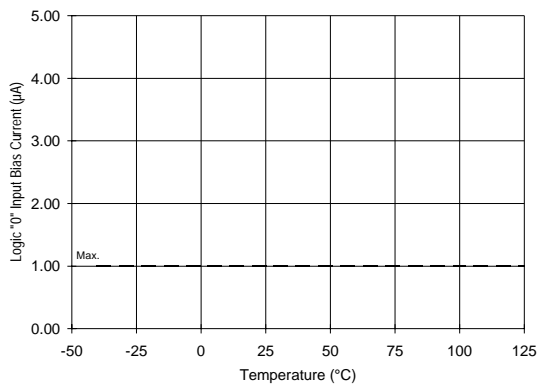

Figure 24A. Logic "0" Input Current vs. Temperature

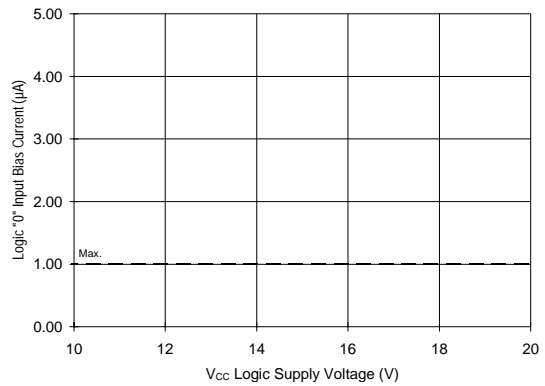

Figure 24B. Logic "0" Input Current vs. Voltage

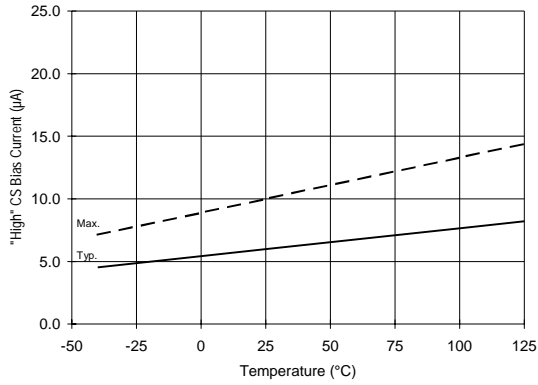

Figure 25A. "High" CS Bias Current vs. Temperature

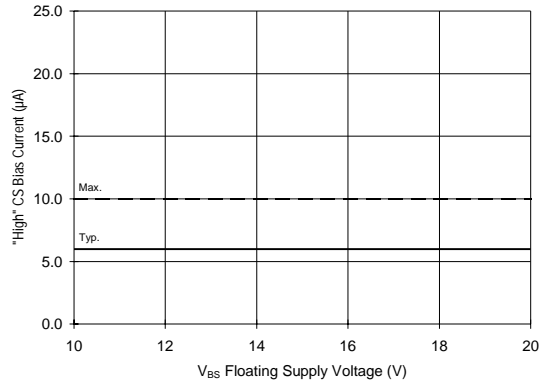

Figure 25B. "High" CS Bias Current vs. Voltage

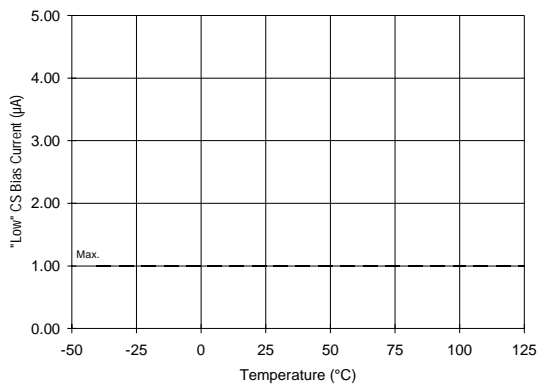

Figure 26A. "Low" CS Bias Current vs. Temperature

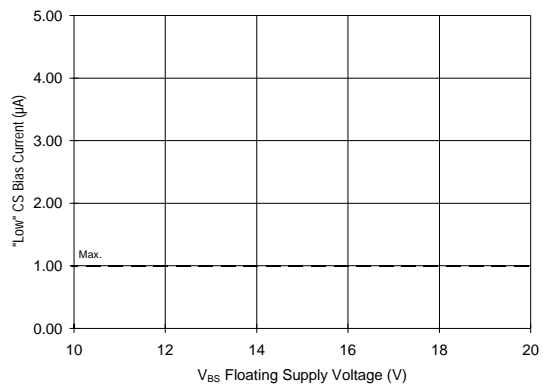

Figure 26B. "Low" CS Bias Current vs. Voltage

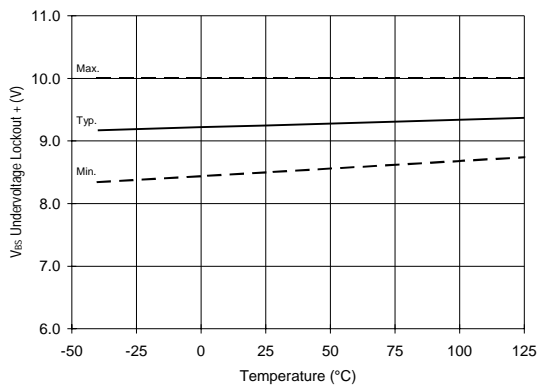

Figure 27. V_{BS} Undervoltage (+) vs. Temperature

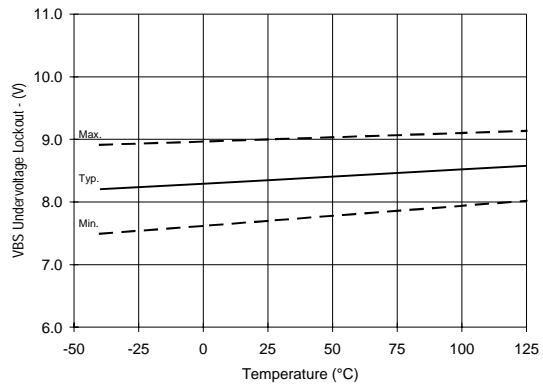

Figure 28. V_{BS} Undervoltage (-) vs. Temperature

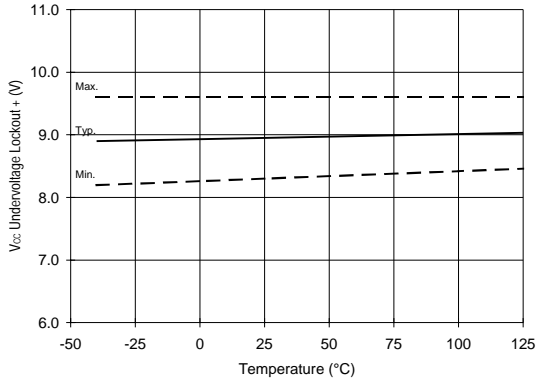

Figure 29. V_{CC} Undervoltage (+) vs. Temperature

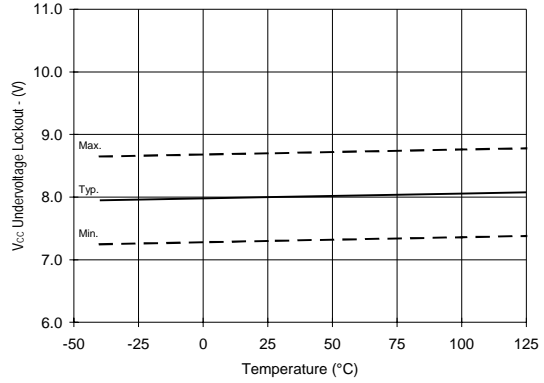

Figure 30. V_{CC} Undervoltage (-) vs. Temperature

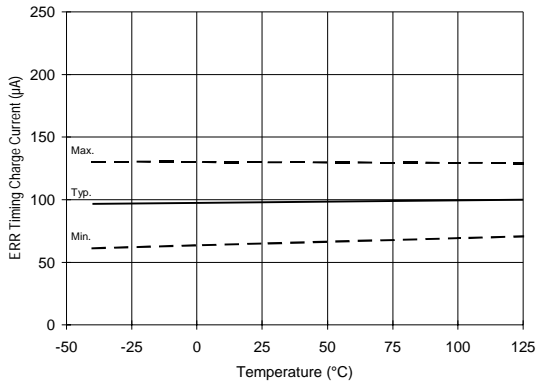

Figure 31A. ERR Timing Charge Current vs. Temperature

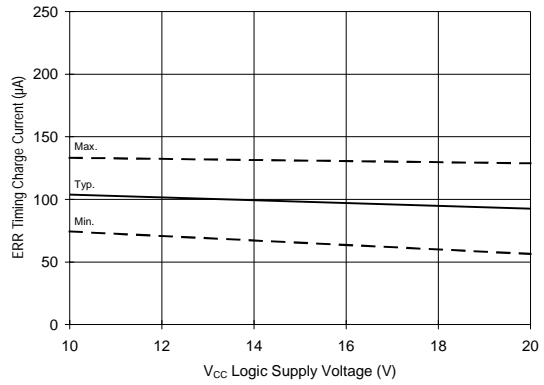

Figure 31B. ERR Timing Charge Current vs. Voltage

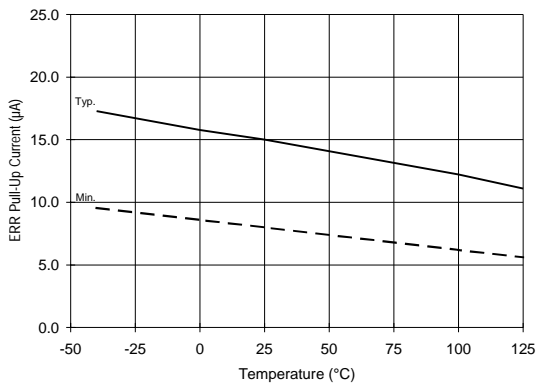

Figure 32A. ERR Pull-Up Current vs. Temperature

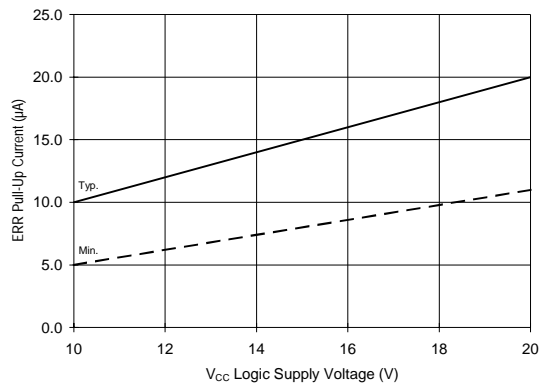

Figure 32B. ERR Pull-Up Current vs. Voltage

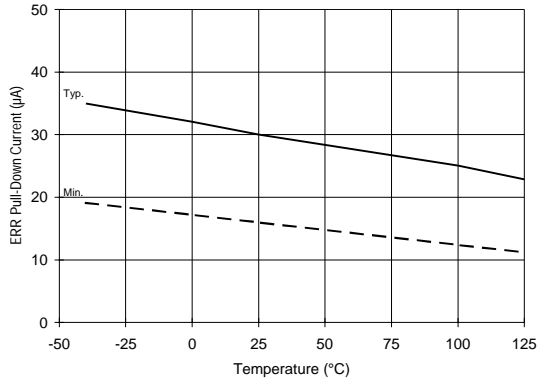

Figure 33A. ERR Pull-Down Current vs. Temperature

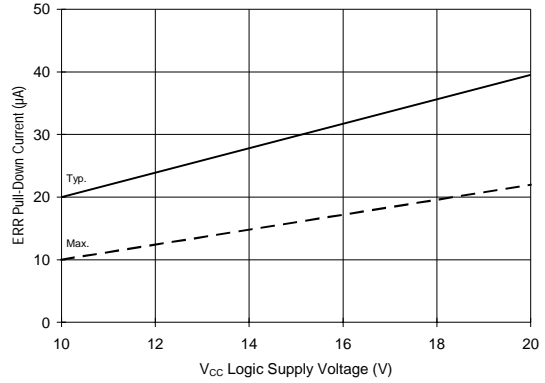

Figure 33B. ERR Pull-Down Current vs. Voltage

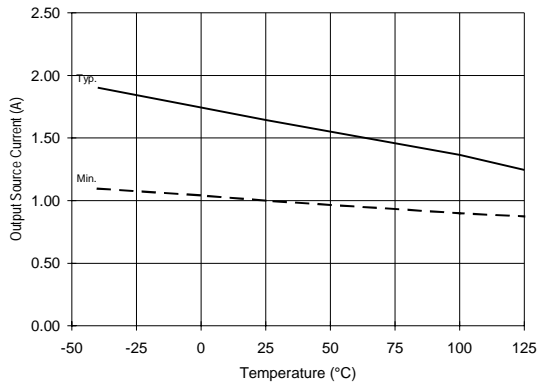

Figure 34A. Output Source Current vs. Temperature

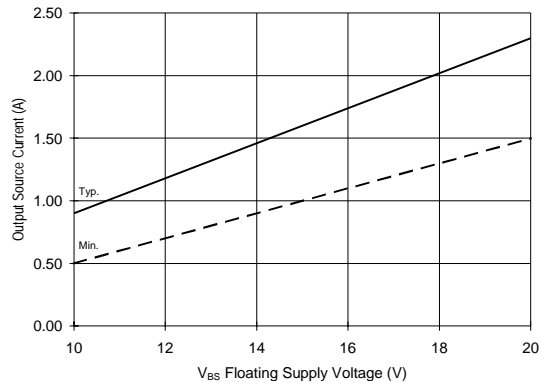

Figure 34B. Output Source Current vs. Voltage

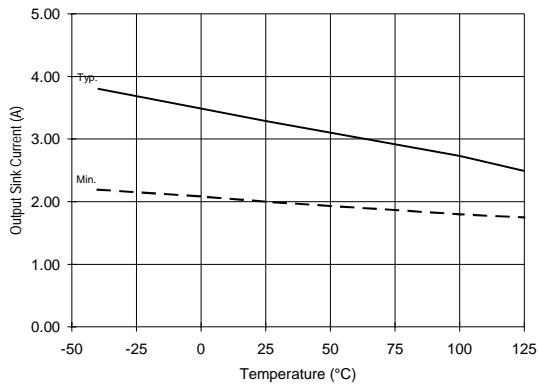

Figure 35A. Output Sink Current vs. Temperature

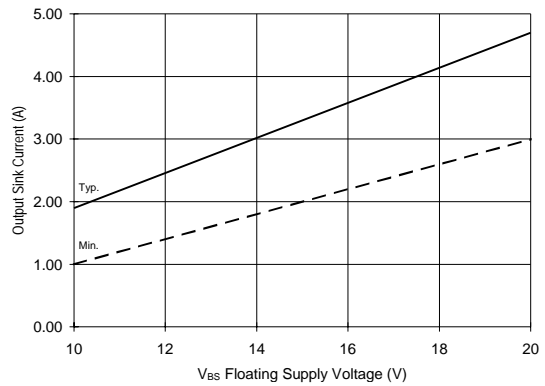

Figure 35B. Output Sink Current vs. Voltage

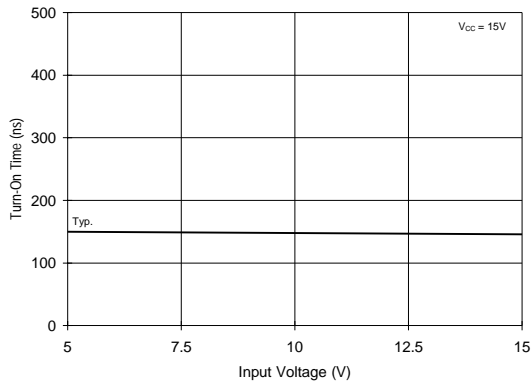

Figure 36A. Turn-On Time vs. Input Voltage

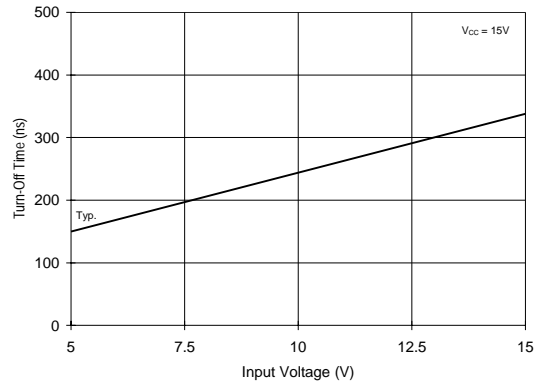

Figure 36B. Turn-Off Time vs. Input Voltage

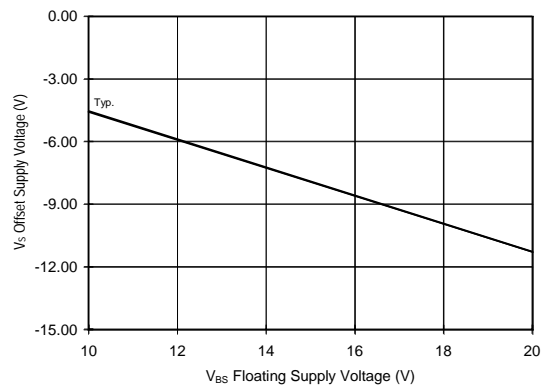
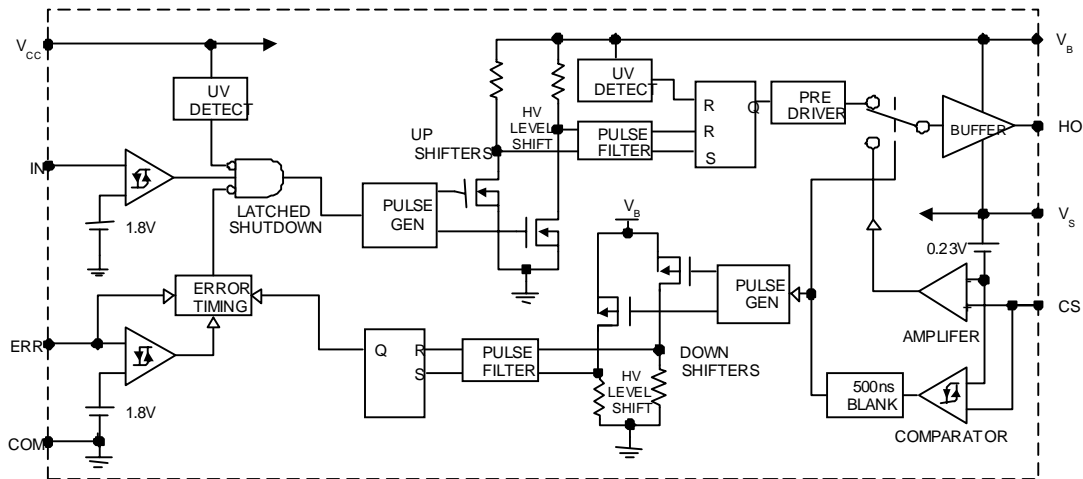

Figure 37. Maximum V_S Negative Offset vs. Supply Voltage

Functional Block Diagram



Lead Definitions

Symbol	Description
V _{CC}	Logic and gate drive supply
IN	Logic input for gate driver output (HO), in phase with HO
ERR	Serves multiple functions; status reporting, linear mode timing and cycle by cycle logic shutdown
COM	Logic ground
V _B	High side floating supply
HO	High side gate drive output
V _S	High side floating supply return
CS	Current sense input to current sense comparator

IR2125Z

International
IR Rectifier

Case Outline and Dimensions- MO-036AA

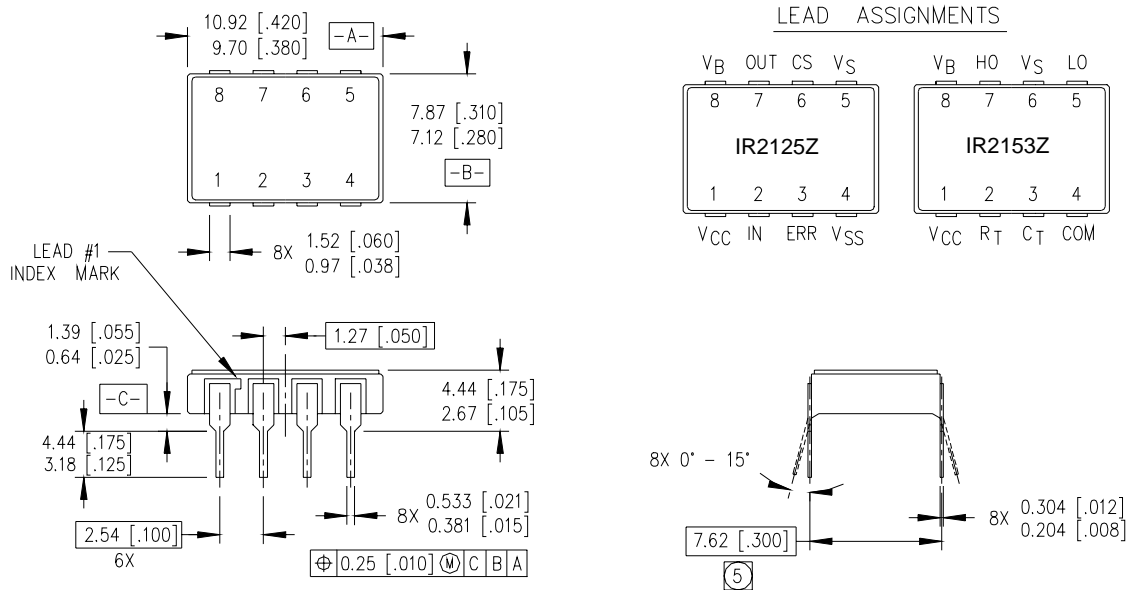

NOTES:

1. DIMENSIONING & TOLERANCING PER ANSI Y14.5M-1982.
2. CONTROLLING DIMENSION: INCH.
3. DIMENSIONS ARE SHOWN IN MILLIMETERS [INCHES].
4. OUTLINE CONFORMS TO JEDEC OUTLINE MO-036AA.
⑤ MEASURED WITH THE LEADS CONSTRAINED TO BE PERPENDICULAR TO DATUM PLANE C.

International
IR Rectifier

IR WORLD HEADQUARTERS: 233 Kansas St., El Segundo, California 90245, USA Tel: (310) 252-7105
TAC Fax: (310) 252-7903

Visit us at www.irf.com for sales contact information.
Data and specifications subject to change without notice. 05/01