



# MAX1499 Evaluation Kit/MAX1499 Evaluation System

## General Description

The MAX1499 evaluation system (EV system) consists of a MAX1499 evaluation kit (EV kit) and a Maxim 68HC16MODULE-DIP microcontroller ( $\mu$ C) module. The MAX1499 is a low-power, 4.5-digit analog-to-digital converter (ADC) with integrated LED display drivers. The evaluation software runs under Windows® 95/98/2000/XP, providing a convenient user interface for exercising the features of the MAX1499.

Order the complete EV system (MAX1499EVC16) for a comprehensive evaluation of the MAX1499 using a personal computer. Order the EV kit (MAX1499EVKIT) if the 68HC16MODULE has already been purchased with a previous Maxim EV system, or for custom use in other  $\mu$ C-based systems.

This system can also evaluate the MAX1498ECJ. Contact factory for free samples. See the *Detailed Description of Hardware* section for more details.

## MAX1499 Stand-Alone EV Kit

The MAX1499 EV kit provides a proven PC board layout to facilitate evaluation of the MAX1499. It must be interfaced to appropriate timing signals for proper operation. Connect 6V to 26VDC and ground return to terminal block TB1 (see Figure 7). Refer to the MAX1499 data sheet for timing requirements.

## MAX1499 EV System

The MAX1499 EV system operates from a user-supplied 7VDC to 20VDC power supply. The evaluation software runs under Windows 95/98/2000/XP on a PC, interfacing to the EV system board through the computer's serial communications port. See the *Quick Start* section for setup and operating instructions.

DESIGNATION	QTY	DESCRIPTION
AIN+, AIN-, REF+, REF-	4	Noninsulated banana jacks Mouser 530-108-0740-1
C1, C2, C11	3	10 $\mu$ F $\pm$ 20%, 10V X7R ceramic capacitors (1210) TDK C3225X7R1C106M Taiyo Yuden LMK325BJ106MN
C3, C4, C5, C7-C10, C12	8	0.1 $\mu$ F $\pm$ 20%, 16V X7R ceramic capacitors (0603) TDK C1608X7R1C104K Taiyo Yuden EMK107BJ104MA

Windows is a registered trademark of Microsoft Corp.



Maxim Integrated Products 1

**For pricing, delivery, and ordering information, please contact Maxim/Dallas Direct! at 1-888-629-4642, or visit Maxim's website at [www.maxim-ic.com](http://www.maxim-ic.com).**

## Features

- ◆ Proven PC Board Layout
- ◆ Complete Evaluation System
- ◆ Convenient On-Board Test Points
- ◆ Data-Logging Software
- ◆ Fully Assembled and Tested

## Ordering Information

PART	TEMP RANGE	INTERFACE TYPE
MAX1499EVKIT	0°C to +70°C	User supplied
MAX1499EVC16	0°C to +70°C	Windows software

**Note:** The MAX1499 evaluation software is designed for use with the complete evaluation system MAX1499EVC16 (includes 68HC16MODULE-DIP module together with MAX1499EVKIT). If the MAX1499 evaluation software will not be used, the MAX1499EVKIT board can be purchased by itself, without the  $\mu$ C.

## MAX1499EVC16 System Component List

PART	QTY	DESCRIPTION
MAX1499EVKIT	1	MAX1499 EV kit
68HC16MODULE-DIP	1	68HC16 $\mu$ C module

## MAX1499 EV Kit Component List

DESIGNATION	QTY	DESCRIPTION
C6	1	4.7 $\mu$ F $\pm$ 10%, 16V X7R ceramic capacitor (1206) TDK C3216X7R1C475K
CLK	1	BNC 50 $\Omega$ PC board vertical mount A/D Electronics 580-002-00
DIG0-DIG4	5	Bicolor seven-segment LED displays, common cathode (DIP-10-0.600in) Kingbright Corporation SBC56-21EGWA
J1	1	2 x 20 right-angle socket

Evaluate: MAX1498/MAX1499

# MAX1499 Evaluation Kit/MAX1499 Evaluation System

## MAX1499 EV Kit Component List (continued)

REFERENCE	QTY	DESCRIPTION
JU10–JU14	5	3 pins
JU1–JU9	9	2 pins
R1	1	133k $\Omega$ 1% resistor (1206)
R2, R12	2	100k $\Omega$ 1% resistors (1206)
R3–R7	5	1k $\Omega$ 5% resistors (1206)
R8, R9	0	Do not install—shorted trace on PC board (1206)
R10	1	500k $\Omega$ potentiometer
R11	1	24k $\Omega$ 5% resistor (1206)
R13, R14	2	10 $\Omega$ 5% resistors (1206)
TB1	1	0.200in two-circuit screw terminal block
TP1–TP4	4	8 pins
U1	1	MAX1499ECJ
U2	1	MAX1659ESA
U3, U4	2	MAX1840EUB or MAX1841EUB
U5	1	MAX6062AEUR-T, FZFY
—	1	PC board, MAX1499 EV kit
—	13	Shunts

## Quick Start

### Required Equipment

Before you begin, you need the following equipment:

- MAX1499EVC16 (contains MAX1499EVKIT board and 68HC16MODULE-DIP)
- DC power supply, +7VDC to +20VDC at 0.5A
- Windows 95/98/2000/XP computer with an available serial (COM) port
- 9-pin I/O extension cable

### Procedure

**Do not turn on the power until all connections are made.**

- 1) Ensure that JU1–JU8 and JU10–JU14 have shunts installed, and that JU9 is open. See the jumper settings in Table 2.
- 2) Carefully connect the boards by aligning the 40-pin header of the MAX1499 EV kit with the 40-pin connector of the 68HC16MODULE-DIP module. Gently press them together. The two boards should be flush against one another.
- 3) Connect a +7VDC to +20VDC power source to the  $\mu$ C module at the terminal block located next to the on/off switch, along the top edge of the  $\mu$ C module. Observe the polarity marked on the board.
- 4) Connect a cable from the computer's serial port to the  $\mu$ C module. If using a 9-pin serial port, use a straight-through, 9-pin female-to-male cable. If the only available serial port uses a 25-pin connector, a standard 25-pin to 9-pin adapter is required. The EV kit software checks the modem status lines (CTS, DSR, and DCD) to confirm that the correct port has been selected.
- 5) Install the evaluation software on your computer by running the INSTALL.EXE program on the disk. The program files are copied and icons are created for them in the Windows Start menu.
- 6) Turn on the power supply.
- 7) Start the MAX1499 program by opening its icon in the Start menu.
- 8) The program will prompt you to connect the  $\mu$ C module and to turn its power on. Slide SW1 to the ON position. Select the correct serial port, and click OK. The program automatically downloads its software to the module.

## Component Suppliers

SUPPLIER	PHONE	FAX	WEBSITE
Kingbright Corporation	909-468-0500 (ext 126)	909-468-0505	www.kingbright.com
Taiyo Yuden	800-348-2496	847-925-0899	www.t-yuden.com
TDK	847-803-6100	847-390-4405	www.component.tdk.com

**Note:** Indicate you are using the MAX1499 when contacting these component suppliers.

# MAX1499 Evaluation Kit/MAX1499 Evaluation System

Evaluate: MAX1498/MAX1499

- 9) Apply an input signal in the range -2V to +2V between AIN+ and AIN-. Observe the readout on the screen.
- 10) To view a graph of the measurements, pull down the **View** menu and click **Graph**.

## *Detailed Description of Software*

### *Measurement*

The **Measurement** tab of the evaluation software mimics the behavior of a digital voltmeter (DVM). The status bits are polled approximately once per second. Whenever the **Data** status bit is one, the ADC result register is read and displayed as **Analog Input Code**. The MAX1499 also displays the result on its own LED display.

The EV kit is not a complete DVM. Additional input scaling and protection circuitry might be required.

Whenever the **Measurement** tab is activated, the software offers to clear the **spi/adc** and **seg\_sel** control bits to zero if they are not already clear.

### *Math Processing*

The evaluation software implements several math functions found in physical systems. Whenever the **Math** tab is activated, the software offers to set the **spi/adc** control bit to one if it is not already set. The software also offers to clear the **seg\_sel** control bit to zero if it is not already clear.

The evaluation software intercepts the ADC result prior to display, calculating a new LED display value whenever the **Measurement** or **Math** tab is active and the **spi/adc** control bit is set to one. Math results are graphed as channel one data, alongside the raw ADC result as channel zero data.

The **Type K Thermocouple** function can be used along with a suitable cold junction connection to convert a type K thermocouple's measured Seebeck voltage into temperature in degrees centigrade. The **a0** coefficient 230 represents a cold junction temperature of +23°C.

### *Control Register*

The **Control Register** tab provides access to all control register bits. Drop down the appropriate combo-box and then click **write**.

### *Limit Registers, ADC Offset, ADC Result, LED Display, and Peak*

The **Results, Displays, Limits** tab provides access to the two's-complement data registers. Each register has a **read** button and a **write** button, except for **ADC**

**RESULT1**, **ADC RESULT2**, and **PEAK RESULT**, which are read only.

Reading the **ADC RESULT1** or **ADC RESULT2** register automatically updates the LED display, regardless of the **seg\_sel** control register setting.

Writing to the ADC OFFSET register affects **ADC RESULT1** and **ADC RESULT2**, regardless of the **off-set\_cal1** control register setting.

### *LED Segment Registers*

The **LED Segments** tab lets the user turn individual LED segments on and off by clicking them with the mouse.

Whenever the **LED Segments** tab is activated, the software offers to set the **seg\_sel** control bit to one if it is not already set.

The **Write LED Text** button translates a text string into approximate seven-segment characters, and then writes the character patterns to the LED display.

### *Graph*

The evaluation software has two options for graphing data. A graph of recent data can be displayed by selecting the **View** menu and then **Graph**. Data can be viewed as a time sequence plot, a histogram plot, or as a table of raw numbers. To control the size and timing of the data runs, activate the sampling tool by clicking the main window's **Collect Samples** button.

Sampled data can be saved to a file in comma-delimited or tab-delimited format. Line numbers and a descriptive header line are optional.

Channel zero plots raw 16-bit ADC result data. Channel one plots LED display data, if math processing is enabled. If extended resolution is enabled, channel two plots raw 20-bit ADC result data.

### *Diagnostics Window*

The diagnostics window is used for factory testing prior to shipping the evaluation kit. It is not intended for customer use.

## *Detailed Description of Hardware*















The MAX1499 device under test (U1) is a low-power, 4.5-digit ADC with integrated LED display drivers. The MAX6062 (U5) provides on-board 2.048V reference voltage. See the MAX1499 EV kit schematic in Figure 7 and refer to the MAX1499 data sheet.





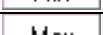
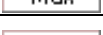

The EV kit includes a MAX1659 high-current 5V linear regulator (U2) and a set of MAX1840/MAX1841 level shifters (U3 and U4) to support the use of 3V logic.

# MAX1499 Evaluation Kit/MAX1499 Evaluation System

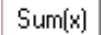
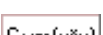
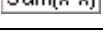
Evaluate: MAX1498/MAX1499

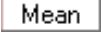
**Table 1. Graph Tool Buttons**

TOOL	FUNCTION
	Show the entire available input range.
	Expand the graph data to fill the window.
	Move the view left or right.
	Move the view up or down.
	Expand or contract the x-axis.
	Expand or contract the y-axis.
	Load data from a file.
	Save data to a file.
	Option to write a header line when saving data.
	Option to write line numbers when saving data.
	View code vs. time plot.
	View histogram plot (cumulative frequency of each code).
	View table.
	Show minimum in tabular view.
	Show maximum in tabular view.
	Show span in tabular view. Span = maximum - minimum.
	Show number of samples in tabular view.

TOOL	FUNCTION
	Show sum of the samples in tabular view.
	Show sum of the squares of the samples in tabular view.
	Show arithmetic mean in tabular view: $\text{Mean} = \frac{\sum(x)}{n}$
	Show standard deviation in tabular view: $\text{Standard deviation} = \sqrt{\frac{n\sum(x^2) - \left(\sum x\right)^2}{(n-1)n}}$
	Show root of the mean of the squares (RMS) in tabular view: $\text{RMS} = \sqrt{\frac{\sum(x^2)}{n}}$
	Channel 0 enable (16-bit ADC result).
	Channel 1 enable (math result).
	Channel 2 enable (20-bit ADC result).

# MAX1499 Evaluation Kit/MAX1499 Evaluation System

Evaluate: MAX1498/MAX1499

**Table 2. Jumper Functions Table**

JUMPER	SHUNT POSITION	FUNCTION
JU1	Closed*	LED displays are powered by U2.
	Open	VLED must be supplied by an external power source.
JU2	Closed*	VDISP = GND.
	Open	Apply VDISP voltage at VDISP pad.
JU3	Closed*	Banana jack AIN+ connects to AIN+ input pin.
	Open	Insert custom filtering between JU3 pins 1 and 2.
JU4	Closed*	Banana jack AIN- connects to AIN- input pin.
	Open	Insert custom filtering between JU4 pins 1 and 2.
JU5	Closed*	REF- = GND.
	Open	REF- must be provided by user.
JU6	Closed*	REF+ = 2.048V from U5, MAX6062.
	Open	REF+ must be provided by user.
JU7	Closed*	REF+ is bypassed by C6.
	Open	C6 is disconnected.
JU8	Closed*	GLED return current flows to DVDD.
	Open	GLED return current flows to external power source.
JU9	Closed	LED_EN = low; LED displays are blanked.
	Open*	LED_EN = high; LED displays are enabled.
JU10– JU14	1-2*	Display color = red.
	2-3	Display color = green.

\*Asterisk indicates default configuration.

**Table 3. Stand-Alone Interface Pin Functions**

U1 PIN	MAX1499 FUNCTION	MAX1498 FUNCTION
8	CLK	INTREF
9	EOC	RANGE
10	CS	DPSET1
11	DIN	DPSET2
12	SCLK	PEAK
13	DOUT	HOLD
30	LOWBATT	DPON

### Evaluating the MAX1498

The MAX1499EVKIT supports stand-alone operation of the MAX1498; however, the evaluation software cannot be used because there is no  $\mu$ C interface.

The MAX1498 is the standalone version of the MAX1499. Refer to MAX1498/MAX1499 data sheet. Request a free sample of MAX1498ECJ.

- 1) The MAX1499EVKIT must be disconnected from the 68HC16MODULE.
- 2) With power disconnected, replace U1 with the MAX1498.
- 3) Connect DC power supply at terminal block TB1.
- 4) Turn on the power supply. The LED display should begin indicating measurement data.

After replacing U1 with the MAX1498, some of the pin functions are different. See Table 3.

### Example Code

Listing 1 shows the variable declarations needed in the EV kit software. Listing 2 contains the functions used in the EV kit software.

# MAX1499 Evaluation Kit/MAX1499 Evaluation System

Evaluate: MAX1498/MAX1499

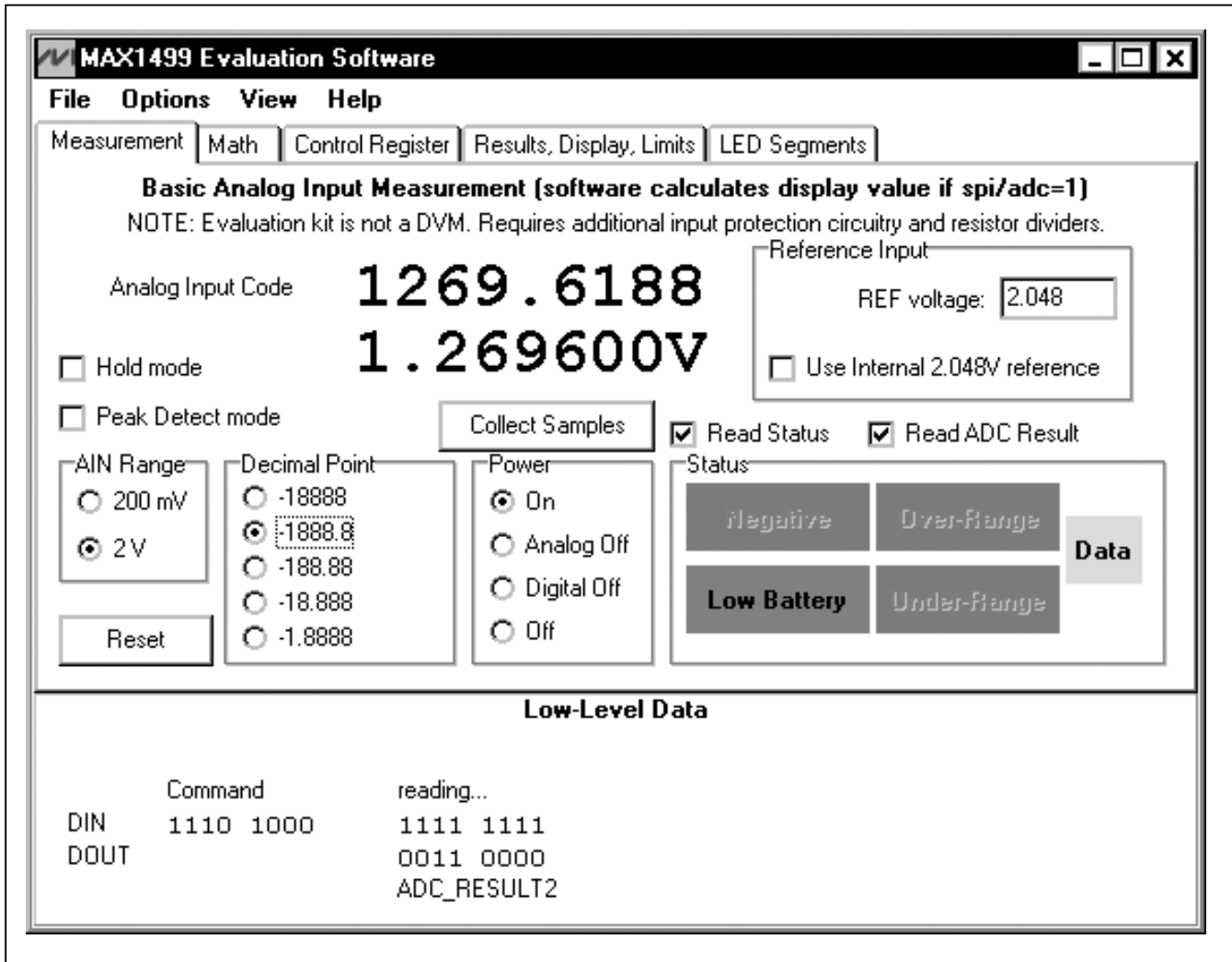

Figure 1. MAX1499 Evaluation Software—Measurement Tab

# MAX1499 Evaluation Kit/MAX1499 Evaluation System

Evaluate: MAX1498/MAX1499

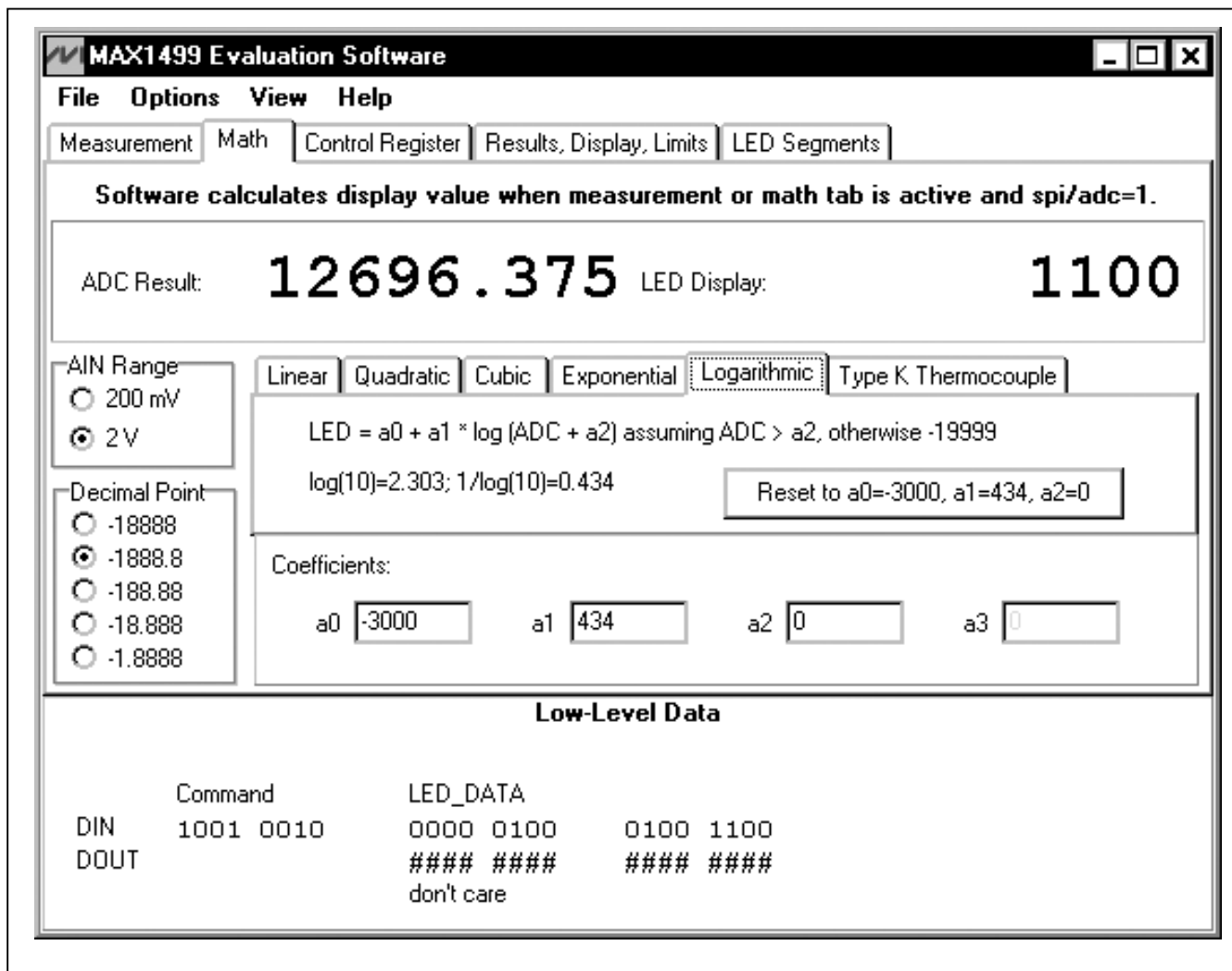

Figure 2. MAX1499 Evaluation Software—Math Tab

# MAX1499 Evaluation Kit/MAX1499 Evaluation System

Evaluate: MAX1498/MAX1499

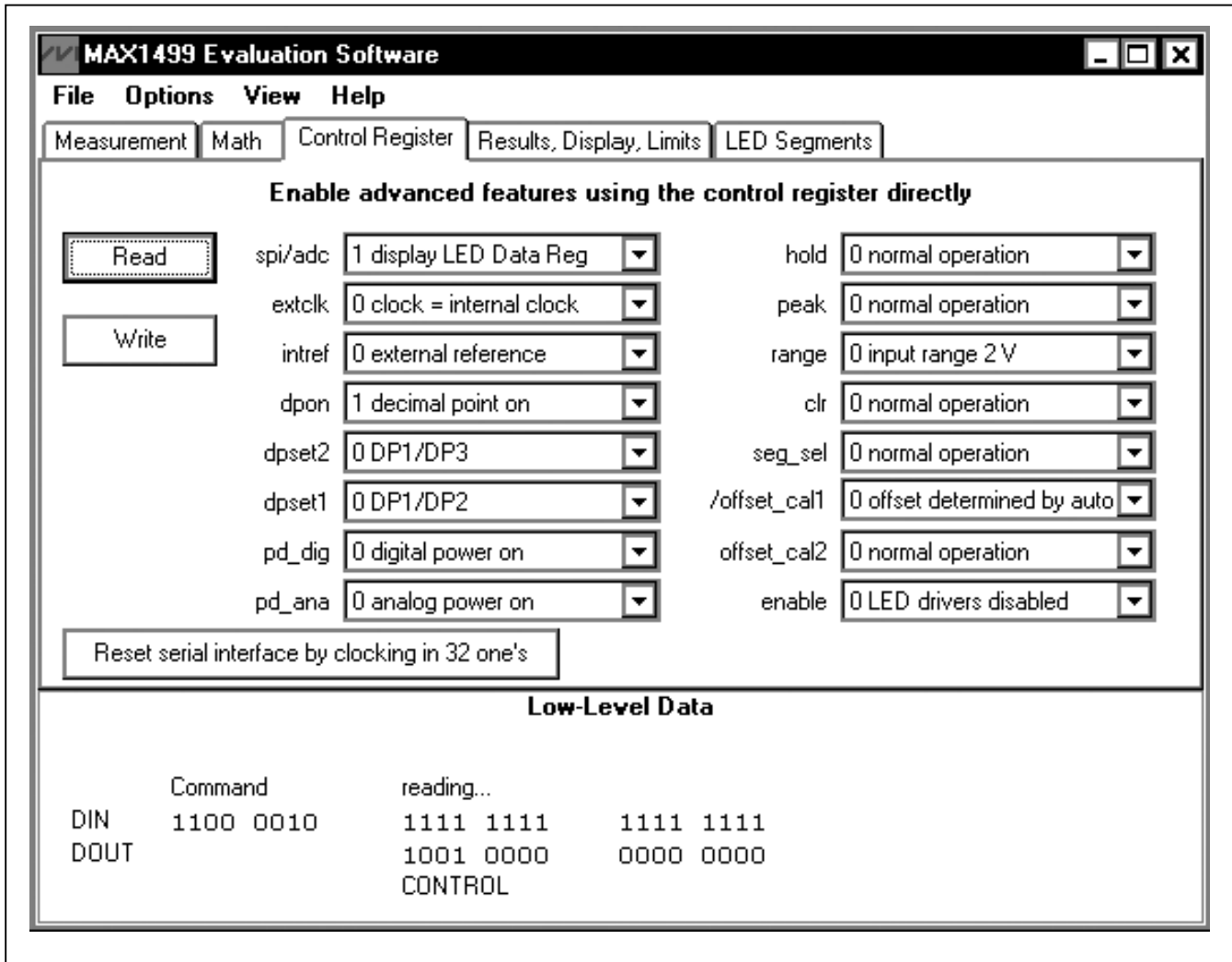

Figure 3. MAX1499 Evaluation Software—Control Register Tab



# MAX1499 Evaluation Kit/MAX1499 Evaluation System

Evaluate: MAX1498/MAX1499

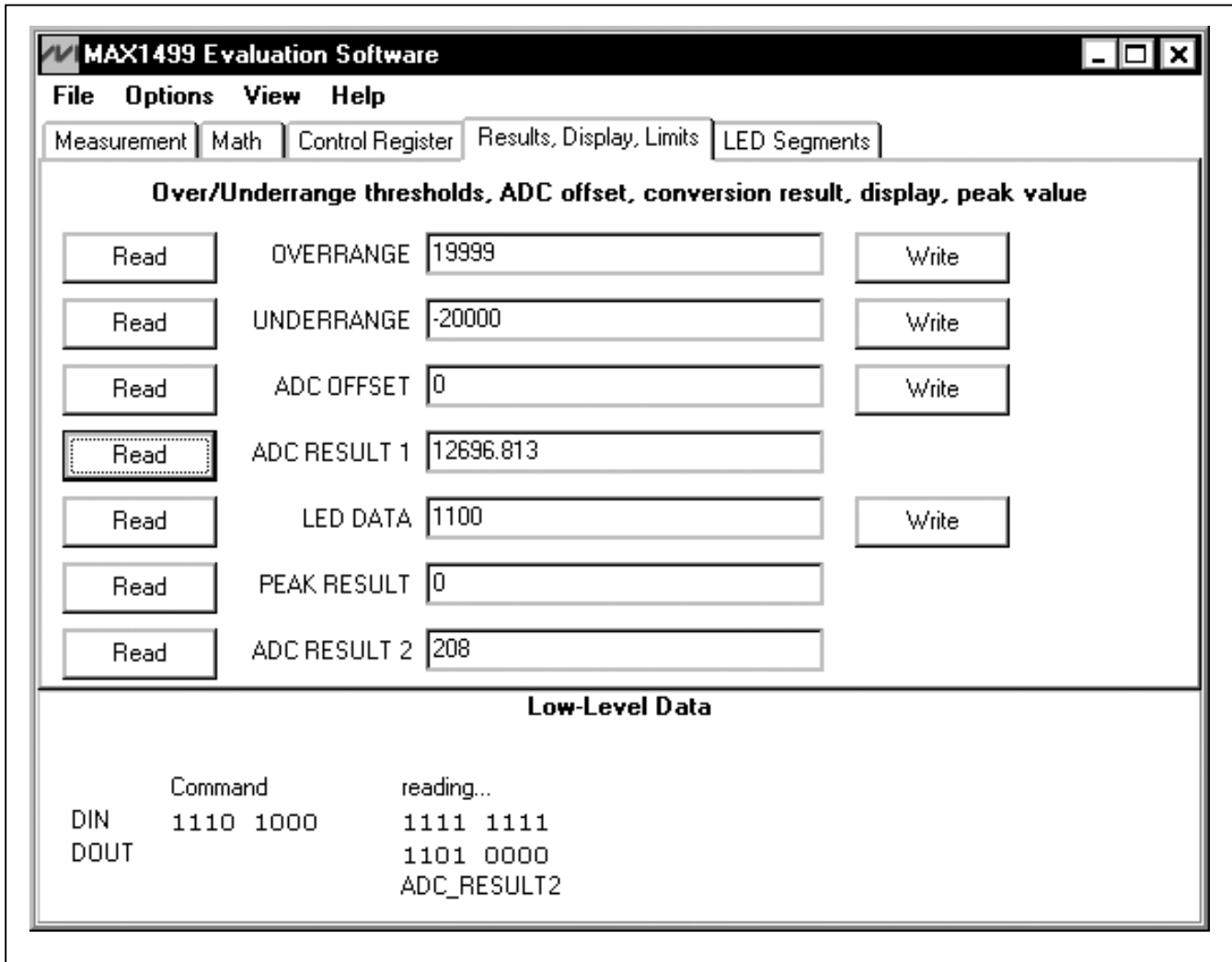

Figure 4. MAX1499 Evaluation Software—Results, Display, Limits Tab

# MAX1499 Evaluation Kit/MAX1499 Evaluation System

Evaluate: MAX1498/MAX1499

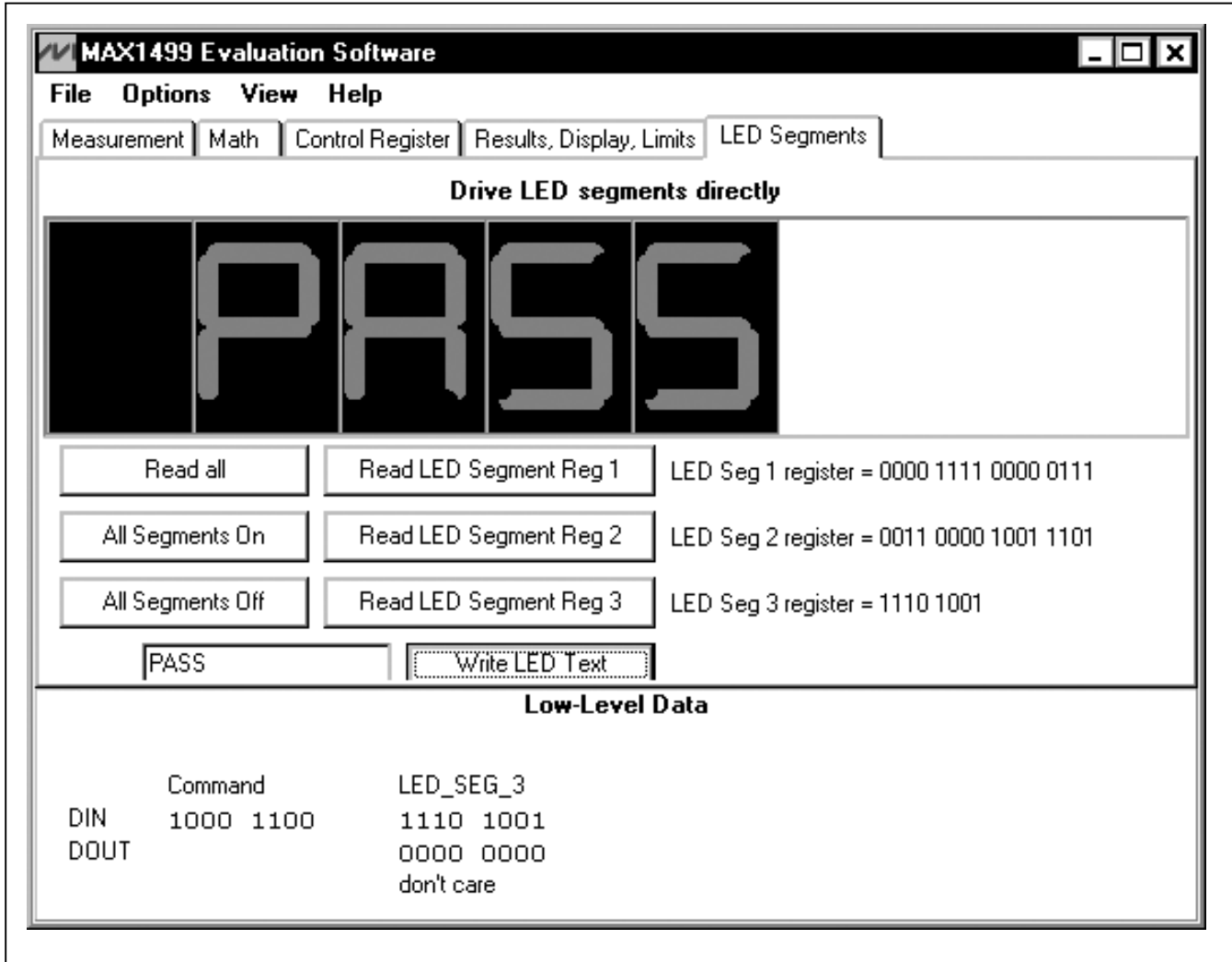

Figure 5. MAX1499 Evaluation Software—LED Segments Tab

# MAX1499 Evaluation Kit/MAX1499 Evaluation System

Evaluate: MAX1498/MAX1499

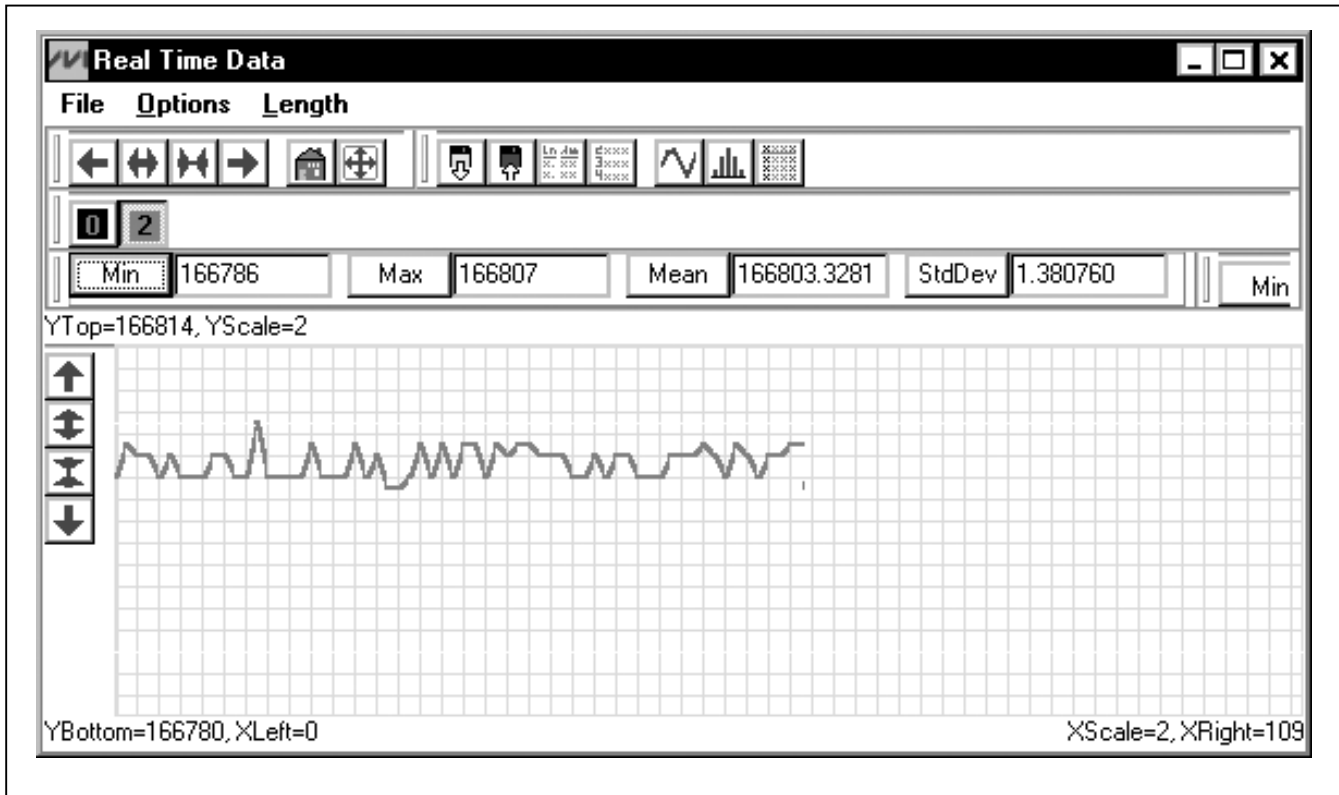

Figure 6. MAX1499 Evaluation Software—Graph

# MAX1499 Evaluation Kit/MAX1499 Evaluation System

Evaluate: MAX1498/MAX1499

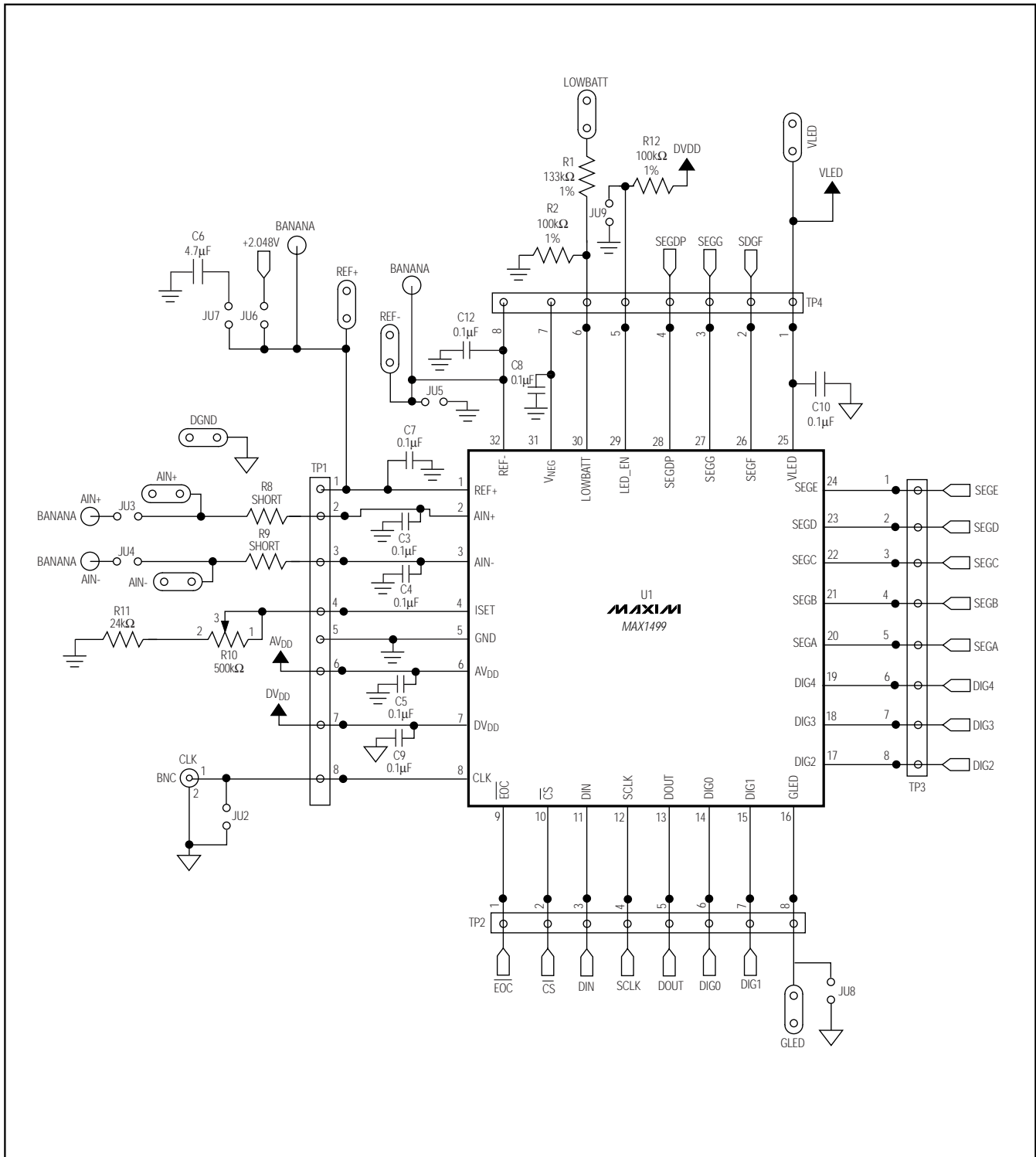

Figure 7a. MAX1499 EV Kit Schematic (Sheet 1 of 2)

# MAX1499 Evaluation Kit/MAX1499 Evaluation System

Evaluate: MAX1498/MAX1499

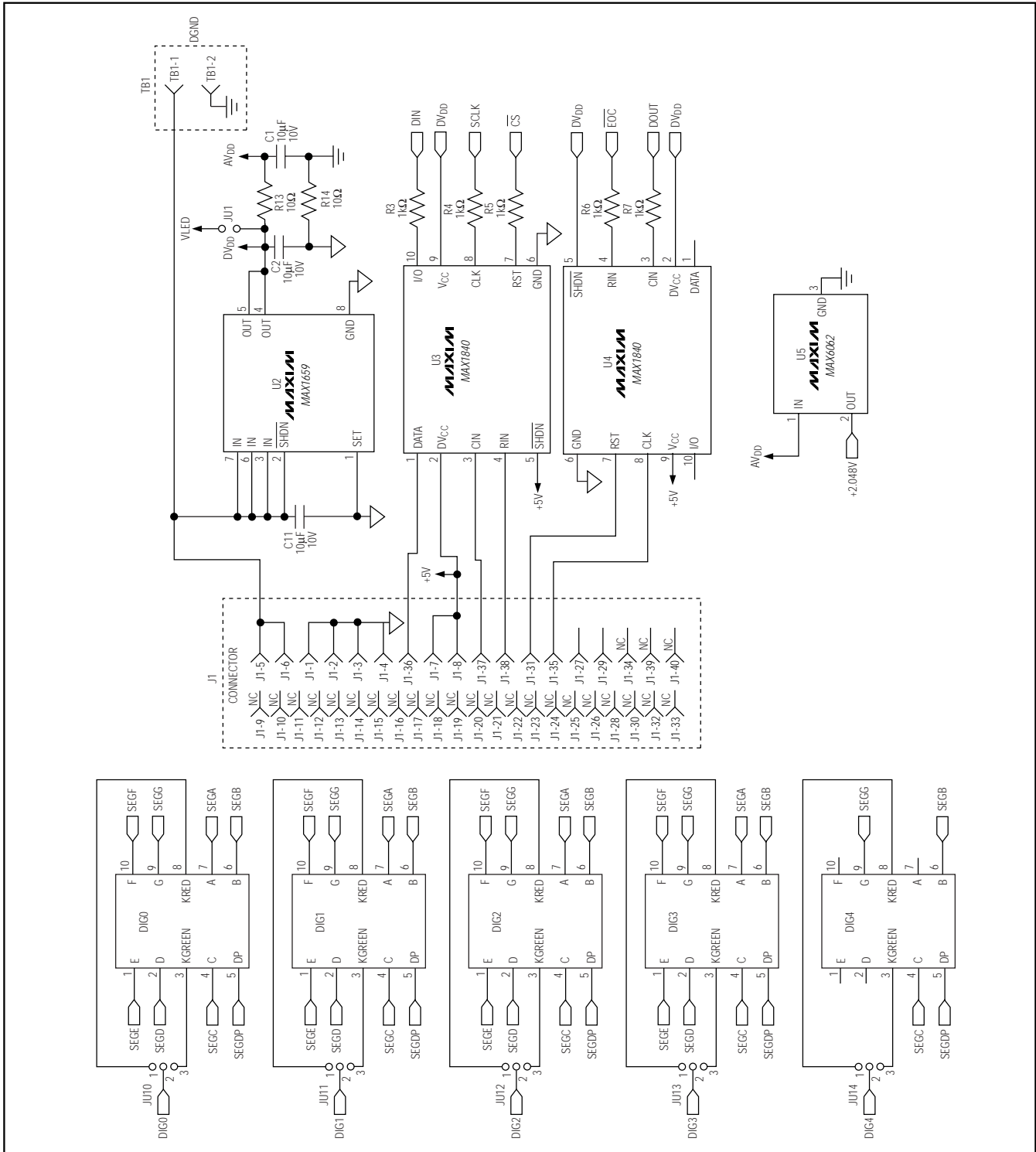

Figure 7b. MAX1499 EV Kit Schematic (Sheet 2 of 2)

# MAX1499 Evaluation Kit/MAX1499 Evaluation System

Evaluate: MAX1498/MAX1499

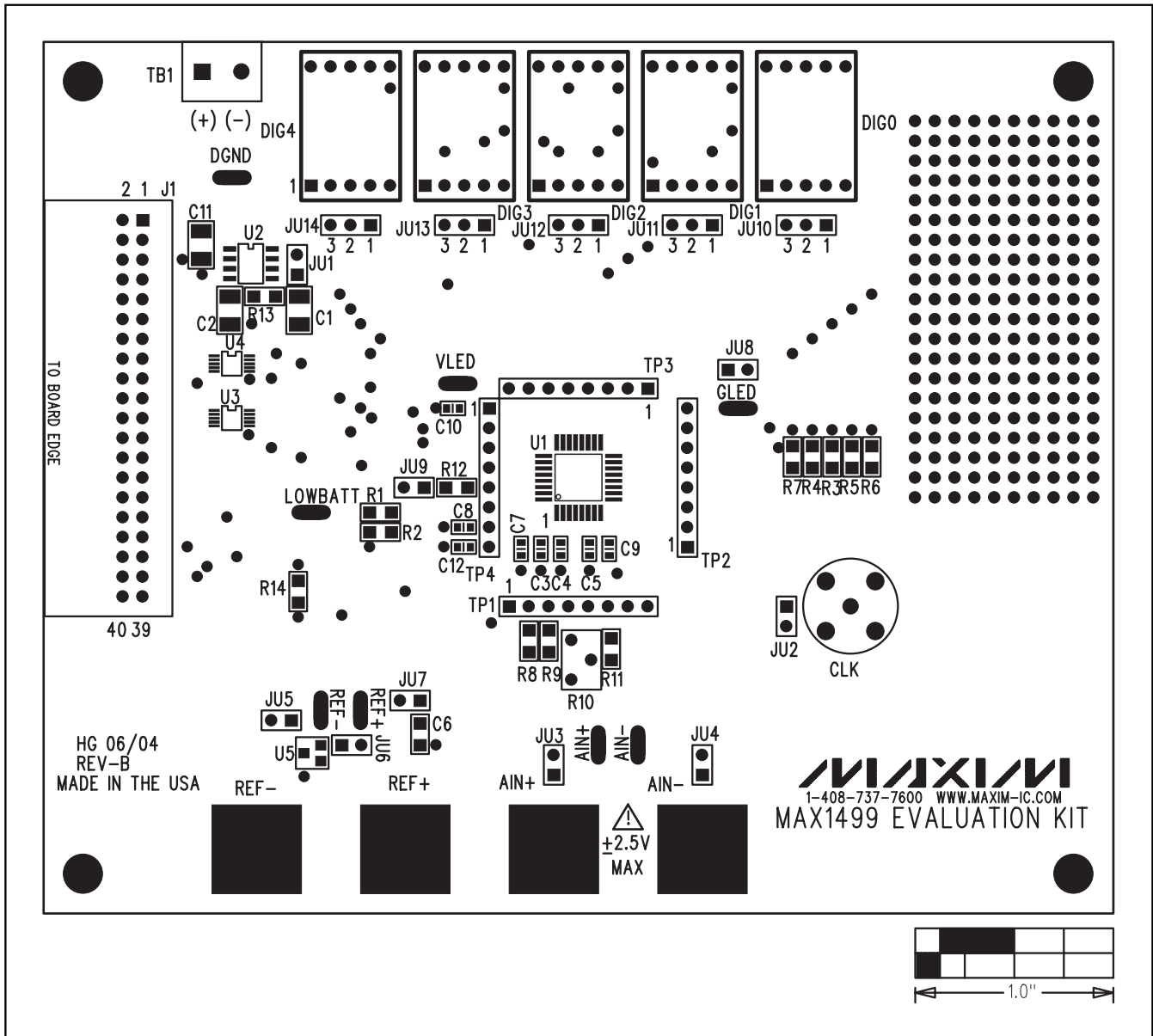

Figure 8. MAX1499 EV Kit Component Placement Guide—Component Side

# MAX1499 Evaluation Kit/MAX1499 Evaluation System

Evaluate: MAX1498/MAX1499

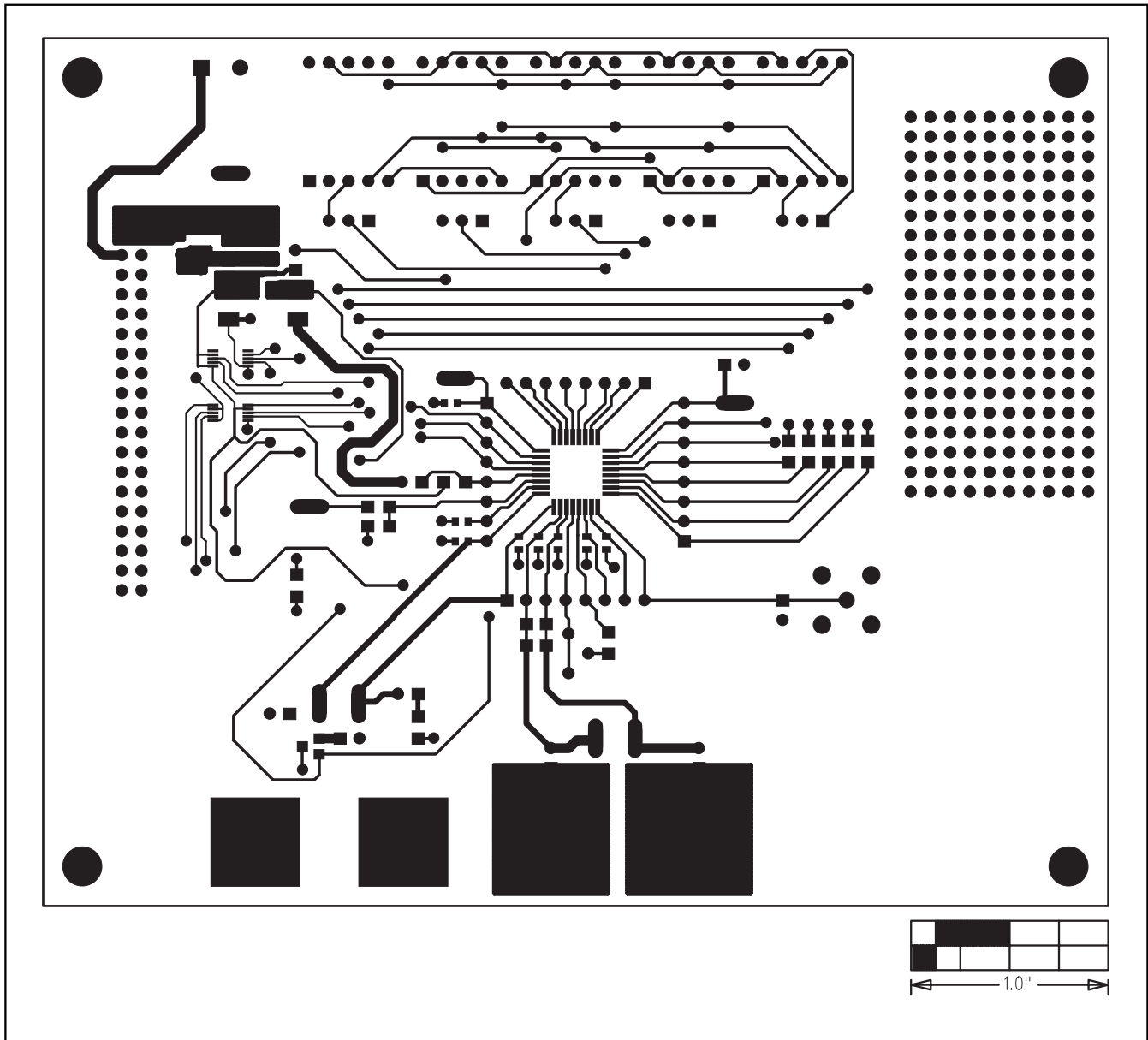

Figure 9. MAX1499 EV Kit PC Board Layout—Component Side

# MAX1499 Evaluation Kit/MAX1499 Evaluation System

Evaluate: MAX1498/MAX1499

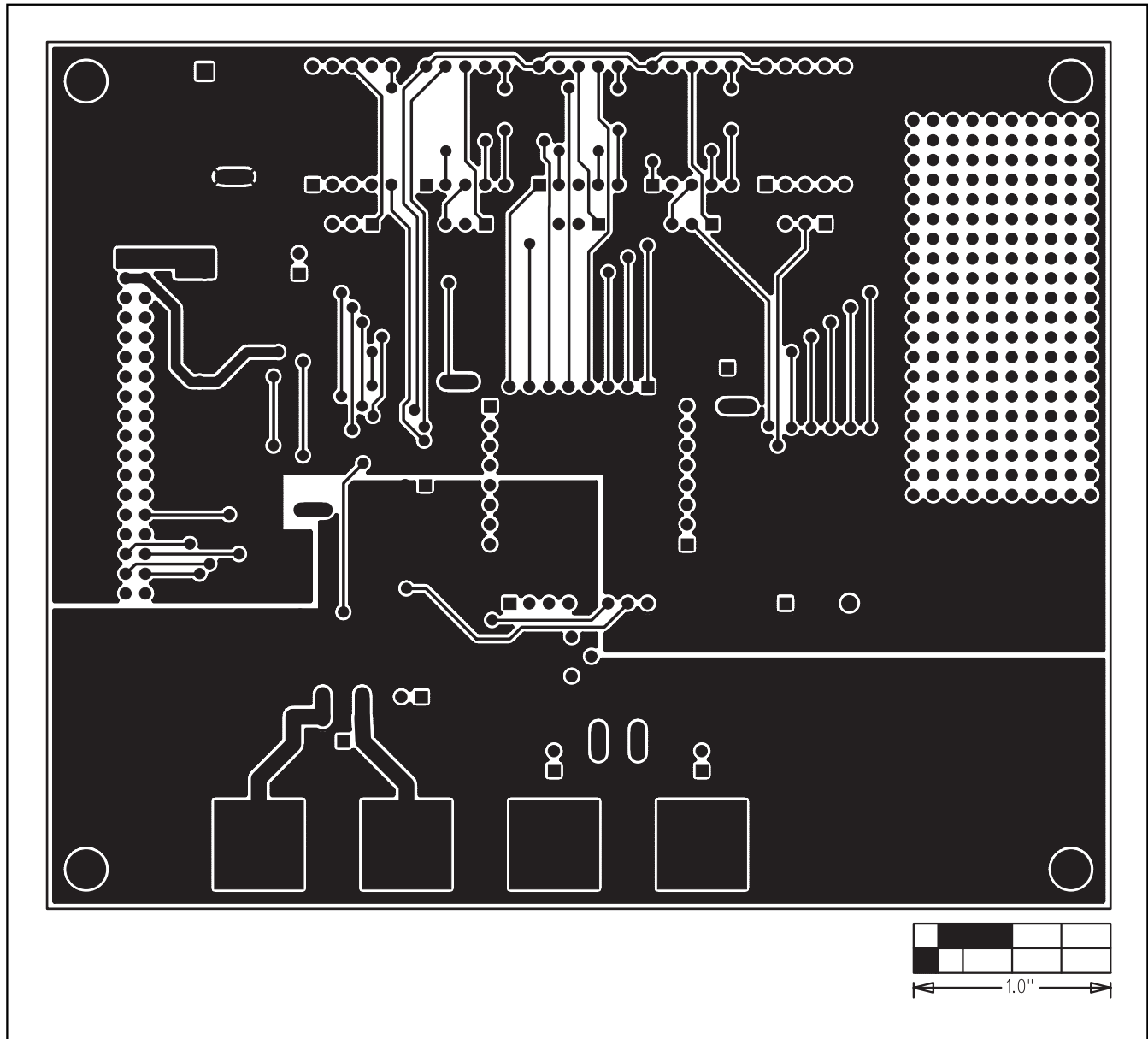

Figure 10. MAX1499 EV Kit PC Board Layout—Solder Side



# MAX1499 Evaluation Kit/MAX1499 Evaluation System

Evaluate: MAX1498/MAX1499

```
// Drv1499.h
// MAX1499-specific driver.
// mku 01/07/2004
// (C) 2004 Maxim Integrated Products
// For use with Borland C++ Builder 3.0
//-----
// Revision history:
// 01/07/2004: modify drv 1 4 9 4 driver to become drv1499
// 12/04/2003: fix indentation
// 09/15/2003: add double Voltage(void)
// 09/12/2003: add SPI_Transfer_After_EOC()
// 09/09/2003: add class MAX1499 dependent on external SPI_Interface()
// 08/13/2003: preliminary draft of reusable code
//-----
#ifndef drv1499H
#define drv1499H
//-----

// The following interface protocols must be provided by
// the appropriate low-level interface code.
//

/* SPI interface:
** byte_count = transfer length
** mosi[] = array of master-out, slave-in data bytes
** miso_buf[] = receive buffer for master-in, slave-out data bytes
*/
extern bool SPI_Transfer(int byte_count,
    const unsigned __int8 mosi[], unsigned __int8 miso_buf[]);

/* SPI interface, with data transfer immediately after EOC is asserted:
** byte_count = transfer length
** mosi[] = array of master-out, slave-in data bytes
** miso_buf[] = receive buffer for master-in, slave-out data bytes
*/
extern bool SPI_Transfer_After_EOC(int byte_count,
    const unsigned __int8 mosi[], unsigned __int8 miso_buf[]);

//-----
// Define the bits in the COMMS register.
// START R/W RS4 RS3 RS2 RS1 RS0 0
#define MAX1499_COMMS_START 0x80
#define MAX1499_COMMS_RW_MASK 0x40
#define MAX1499_COMMS_RW_WRITE 0x00
#define MAX1499_COMMS_RW_READ 0x40
#define MAX1499_COMMS_RS_MASK 0x3E
#define MAX1499_COMMS_RS_00000 0x00
#define MAX1499_COMMS_RS_STATUS 0x00
#define MAX1499_COMMS_RS_00001 0x02
#define MAX1499_COMMS_RS_CONTROL 0x02
#define MAX1499_COMMS_RS_00010 0x04
#define MAX1499_COMMS_RS_OVERRANGE 0x04
#define MAX1499_COMMS_RS_00011 0x06
#define MAX1499_COMMS_RS_UNDERRANGE 0x06
#define MAX1499_COMMS_RS_00100 0x08
#define MAX1499_COMMS_RS_LED_SEG_1 0x08
#define MAX1499_COMMS_RS_00101 0x0A
#define MAX1499_COMMS_RS_LED_SEG_2 0x0A
#define MAX1499_COMMS_RS_00110 0x0C
#define MAX1499_COMMS_RS_LED_SEG_3 0x0C
#define MAX1499_COMMS_RS_00111 0x0E
#define MAX1499_COMMS_RS_ADC_OFFSET 0x0E
#define MAX1499_COMMS_RS_01000 0x10
#define MAX1499_COMMS_RS_ADC_RESULT1 0x10
#define MAX1499_COMMS_RS_01001 0x12
#define MAX1499_COMMS_RS_LED_DATA 0x12
#define MAX1499_COMMS_RS_01010 0x14
#define MAX1499_COMMS_RS_PEAK 0x14
#define MAX1499_COMMS_RS_10100 0x28
#define MAX1499_COMMS_RS_ADC_RESULT2 0x28

//-----
// Define the bits in the STATUS register.
// POL OVR_RNG UNDR_RNG LOW_BATT ADD(data available) 0 0 0
```

Listing 1 (Sheet 1 of 4)

# MAX1499 Evaluation Kit/MAX1499 Evaluation System

Evaluate: MAX1498/MAX1499

```

#define MAX1499_STATUS_POL_MASK          0x80
#define MAX1499_STATUS_POL_POSITIVE     0x00
#define MAX1499_STATUS_POL_NEGATIVE     0x80
#define MAX1499_STATUS_OVER_RANGE       0x40
#define MAX1499_STATUS_UNDER_RANGE      0x20
#define MAX1499_STATUS_LOW_BATTERY      0x10
#define MAX1499_STATUS_DATA_READY       0x08

//-----
// Define the bits in the CONTROL register.
// SPI_ADC EXTCLK INTREF DPON DPSET2 DPSET1 PD_DIG PD_ANA
// HOLD PEAK RANGE CLR LED_OFFSET_CAL1 OFFSET_CAL2 ENABLE
#define MAX1499_CONTROL_SPI_ADC          0x8000
#define MAX1499_CONTROL_EXTCLK           0x4000
#define MAX1499_CONTROL_INTREF           0x2000
#define MAX1499_CONTROL_DPMASK          0x1C00
#define MAX1499_CONTROL_DPON             0x1000
#define MAX1499_CONTROL_DPSET2           0x0800
#define MAX1499_CONTROL_DPSET1           0x0400
// (DPSET2 is the LSB and DPSET1 is the MSB)
#define MAX1499_CONTROL_DP1ON            0x1000 /* -1888.8 */
#define MAX1499_CONTROL_DP2ON            0x1800 /* -188.88 */
#define MAX1499_CONTROL_DP3ON            0x1400 /* -18.888 */
#define MAX1499_CONTROL_DP4ON            0x1C00 /* -1.8888 */
#define MAX1499_CONTROL_PD_DIG           0x0200
#define MAX1499_CONTROL_PD_ANA           0x0100
#define MAX1499_CONTROL_PD_ALL           0x0300
#define MAX1499_CONTROL_HOLD             0x0080
#define MAX1499_CONTROL_PEAK             0x0040
#define MAX1499_CONTROL_RANGE_200mV     0x0020
#define MAX1499_CONTROL_CLR               0x0010
#define MAX1499_CONTROL_SEG_SEL           0x0008
#define MAX1499_CONTROL_OFFSET_CAL1      0x0004
#define MAX1499_CONTROL_OFFSET_CAL2      0x0002
#define MAX1499_CONTROL_ENABLE            0x0001

//-----
// Define the bits in the LED SEGMENT 1 register.
// A2 G2 D2 F2 E2 DP2 0 B1
// C1 A1 G1 D1 F1 E1 DP1 0
//
#define MAX1499_LED_SEG1_A1               0x8000
#define MAX1499_LED_SEG1_G1               0x4000
#define MAX1499_LED_SEG1_D1               0x2000
#define MAX1499_LED_SEG1_F1               0x1000
#define MAX1499_LED_SEG1_E1               0x0800
#define MAX1499_LED_SEG1_DP2              0x0400
#define MAX1499_LED_SEG1_B0               0x0100
#define MAX1499_LED_SEG1_C0               0x0080
#define MAX1499_LED_SEG1_A0               0x0040
#define MAX1499_LED_SEG1_G0               0x0020
#define MAX1499_LED_SEG1_D0               0x0010
#define MAX1499_LED_SEG1_F0               0x0008
#define MAX1499_LED_SEG1_E0               0x0004
#define MAX1499_LED_SEG1_DP1              0x0002

//-----
// Define the bits in the LED SEGMENT 2 register.
// F4 E4 DP4 G4 B3 C3 A3 G3
// D3 F3 E3 DP3 0 B2 C2 0
//
#define MAX1499_LED_SEG2_F3                0x8000
#define MAX1499_LED_SEG2_E3                0x4000
#define MAX1499_LED_SEG2_DP4               0x2000
#define MAX1499_LED_SEG2_MINUS             0x1000 /* TODO: is this documented? minus sign
*/
#define MAX1499_LED_SEG2_B2                0x0800
#define MAX1499_LED_SEG2_C2                0x0400
#define MAX1499_LED_SEG2_A2                0x0200
#define MAX1499_LED_SEG2_G2                0x0100
#define MAX1499_LED_SEG2_D2                0x0080
#define MAX1499_LED_SEG2_F2                0x0040
#define MAX1499_LED_SEG2_E2                0x0020

```

Listing 1 (Sheet 2 of 4)

# MAX1499 Evaluation Kit/MAX1499 Evaluation System

Evaluate: MAX1498/MAX1499

```
#define MAX1499_LED_SEG2_DP3      0x0010
#define MAX1499_LED_SEG2_B1      0x0004
#define MAX1499_LED_SEG2_C1      0x0002

//-----
// Define the bits in the LED SEGMENT 3 register.
// 0 0 BC5 B4 C4 A4 G4 D4
//
#define MAX1499_LED_SEG3_BC_      0x20
#define MAX1499_LED_SEG3_B3      0x10
#define MAX1499_LED_SEG3_C3      0x08
#define MAX1499_LED_SEG3_A3      0x04
#define MAX1499_LED_SEG3_G3      0x02
#define MAX1499_LED_SEG3_D3      0x01

//-----
class MAX1499
{
public:
    MAX1499(void);

    // Enumerated type describing the register select bits.
    enum RegisterSelect_t {
        RS_STATUS      = MAX1499_COMMS_RS_STATUS,
        RS_CONTROL      = MAX1499_COMMS_RS_CONTROL,
        RS_OVERRANGE    = MAX1499_COMMS_RS_OVERRANGE,
        RS_UNDERRANGE   = MAX1499_COMMS_RS_UNDERRANGE,
        RS_LED_SEG_1    = MAX1499_COMMS_RS_LED_SEG_1,
        RS_LED_SEG_2    = MAX1499_COMMS_RS_LED_SEG_2,
        RS_LED_SEG_3    = MAX1499_COMMS_RS_LED_SEG_3,
        RS_ADC_OFFSET   = MAX1499_COMMS_RS_ADC_OFFSET,
        RS_ADC_RESULT1  = MAX1499_COMMS_RS_ADC_RESULT1,
        RS_LED_DATA     = MAX1499_COMMS_RS_LED_DATA,
        RS_PEAK         = MAX1499_COMMS_RS_PEAK,
        RS_ADC_RESULT2  = MAX1499_COMMS_RS_ADC_RESULT2
    };

    // Reference voltage
    //
    double vref;

    //-----
    // Status Register
    // POL OVR_RNG UNDR_RNG LOW_BATT ADD(data available) 0 0 0
    int STATUS_REG;
    //
    bool Read_STATUS(void);

    //-----
    // Control Register
    // SPI_ADC EXTCLK INTREF DPON DPSET2 DPSET1 PD_DIG PD_ANA
    // HOLD PEAK RANGE CLR LED_OFFSET_CAL1 OFFSET_CAL2 ENABLE
    int CONTROL_REG;
    //
    bool Write_CONTROL(int data);
    bool Read_CONTROL(void);

    //-----
    // Data Registers
    int ADC_RESULT1;
    unsigned int ADC_RESULT2;
    //
    bool Read_ADC_RESULT1(void);
    bool Read_ADC_RESULT2(void);
    long int DATA_REG; // 16-bit or 24-bit result from A/D converter
    bool extended_resolution;
    long Read_DATA(void);
    double Voltage(void);

    //-----
    // Other registers, having 16-bit 2's complement data format
    bool Write_2s_complement(int reg, int data);
    int Read_2s_complement(int reg);
};
```

Listing 1 (Sheet 3 of 4)

# MAX1499 Evaluation Kit/MAX1499 Evaluation System

Evaluate: MAX1498/MAX1499

```
//-----  
// Other registers, having 8 bit data format  
bool Write_8bit_reg(int reg, int data);  
int Read_8bit_reg(int reg);  
  
};  
  
//-----  
#endif
```

Listing 1 (Sheet 4 of 4)

# MAX1499 Evaluation Kit/MAX1499 Evaluation System

Evaluate: MAX1498/MAX1499

```
// Drv1499.cpp
// MAX1499-specific driver.
// mku 09/15/2003
// (C) 2003 Maxim Integrated Products
// For use with Borland C++ Builder 3.0
//-----
// Revision history:
// 09/15/2003: add double Voltage(void)
// 09/09/2003: add class MAX1499 dependent on external SPI_Interface()
// 08/13/2003: preliminary draft of reusable code

#include "drv1499.h"
//-----
MAX1499::MAX1499(void)
{
    vref = 2.048;
    extended_resolution = false;
}
//-----
bool MAX1499::Read_STATUS(void)
{
    const unsigned __int8 mosi[] = {
        (unsigned __int8)(MAX1499_COMMS_START |
            MAX1499_COMMS_RW_READ | MAX1499_COMMS_RS_STATUS),
        (unsigned __int8)(0xFF)
    };
    unsigned __int8 miso_buf[sizeof(mosi)];
    bool result = SPI_Transfer(sizeof(mosi), mosi, miso_buf);
    if (result) {
        int data = miso_buf[1];
        STATUS_REG = data; // remember the value we just received
    }
    return result;
}
//-----
bool MAX1499::Write_CONTROL(int data)
{
    data = data & 0xFFFF; // validate the data
    const unsigned __int8 mosi[] = {
        (unsigned __int8)(MAX1499_COMMS_START |
            MAX1499_COMMS_RW_WRITE | MAX1499_COMMS_RS_CONTROL),
        (unsigned __int8)((data >> 8) & 0xFF),
        (unsigned __int8)(data & 0xFF)
    };
    unsigned __int8 miso_buf[sizeof(mosi)];
    bool result = SPI_Transfer(sizeof(mosi), mosi, miso_buf);
    CONTROL_REG = data; // remember the value we just wrote
    // The CLR bit is self-clearing, and should not be kept high.
    CONTROL_REG &=~ MAX1499_CONTROL_CLR;
    return result;
}
//-----
bool MAX1499::Read_CONTROL(void)
{
    const unsigned __int8 mosi[] = {
        (unsigned __int8)(MAX1499_COMMS_START |
            MAX1499_COMMS_RW_READ | MAX1499_COMMS_RS_CONTROL),
        (unsigned __int8)(0xFF),
        (unsigned __int8)(0xFF)
    };
    unsigned __int8 miso_buf[sizeof(mosi)];
    bool result = SPI_Transfer(sizeof(mosi), mosi, miso_buf);
    if (result) {
        int data = miso_buf[1] * 0x100 + miso_buf[2];
        CONTROL_REG = data; // remember the value we just wrote
    }
    return result;
}
//-----
bool MAX1499::Read_ADC_RESULT1(void)
{
    const unsigned __int8 mosi[] = {
```

Listing 2 (Sheet 1 of 4)

# MAX1499 Evaluation Kit/MAX1499 Evaluation System

```

        (unsigned __int8)(MAX1499_COMMS_START |
            MAX1499_COMMS_RW_READ | MAX1499_COMMS_RS_ADC_RESULT1),
        (unsigned __int8)(0xFF),
        (unsigned __int8)(0xFF)
    };
    unsigned __int8 miso_buf[sizeof(mosi)];
    bool result = SPI_Transfer_After_EOC(sizeof(mosi), mosi, miso_buf);
    if (result) {
        ADC_RESULT1 = (miso_buf[1] * 0x100L) + miso_buf[2];
        long data = (miso_buf[1] * 0x100L) + miso_buf[2];
        if (data >= 32768) {
            data -= 65536;
        }
        DATA_REG = data;           // remember the value we just received
    }
    return result;
}
//-----
bool MAX1499::Read_ADC_RESULT2(void)
{
    const unsigned __int8 mosi[] = {
        (unsigned __int8)(MAX1499_COMMS_START |
            MAX1499_COMMS_RW_READ | MAX1499_COMMS_RS_ADC_RESULT2),
        (unsigned __int8)(0xFF)
    };
    unsigned __int8 miso_buf[sizeof(mosi)];
    bool result = SPI_Transfer(sizeof(mosi), mosi, miso_buf);
    if (result) {
        ADC_RESULT2 = miso_buf[1];
        long data_24 = ((long)ADC_RESULT1 * 0x100L) + ADC_RESULT2;
        DATA_REG = data_24;
    }
    return result;
}
//-----
long MAX1499::Read_DATA(void)
{
    // Read the DATA register
    const unsigned __int8 mosi[] = {
        (unsigned __int8)(MAX1499_COMMS_START |
            MAX1499_COMMS_RW_READ | MAX1499_COMMS_RS_ADC_RESULT1),
        (unsigned __int8)(0xFF),
        (unsigned __int8)(0xFF)
    };
    unsigned __int8 miso_buf[sizeof(mosi)];
    if (SPI_Transfer_After_EOC(sizeof(mosi), mosi, miso_buf) == false) {
        return 0; // failure
    }
    ADC_RESULT1 = (miso_buf[1] * 0x100L) + miso_buf[2];
    long data = (miso_buf[1] * 0x100L) + miso_buf[2];
    if (data >= 32768) {
        data -= 65536;
    }
    DATA_REG = data;           // remember the value we just received
    if (extended_resolution) {
        // Read the ADC_RESULT2 register
        const unsigned __int8 mosi[] = {
            (unsigned __int8)(MAX1499_COMMS_START |
                MAX1499_COMMS_RW_READ | MAX1499_COMMS_RS_ADC_RESULT2),
            (unsigned __int8)(0xFF)
        };
        unsigned __int8 miso_buf[sizeof(mosi)];
        if (SPI_Transfer(sizeof(mosi), mosi, miso_buf) == false) {
            return 0; // failure
        }
        ADC_RESULT2 = miso_buf[1];
        long data_24 = ((long)ADC_RESULT1 * 0x100L) + ADC_RESULT2;
        double data_16 = data_24 / 256.0;
        if (data_16 >= 32768) {
            data_16 = data_16 - 65536;
        }
        DATA_REG = data_24;
    }
}

```

Listing 2 (Sheet 2 of 4)

# MAX1499 Evaluation Kit/MAX1499 Evaluation System

Evaluate: MAX1498/MAX1499

```
    }
    return DATA_REG;
}
//-----
double MAX1499::Voltage(void)
{
    if ((CONTROL_REG & MAX1499_CONTROL_RANGE_200mV) == 0) {
        // Input range 2V
        return DATA_REG * (vref / 2.048) * 10e-6 * 10;
    } else {
        // Input range 200mV
        return DATA_REG * (vref / 2.048) * 10e-6;
    }
}
//-----
bool MAX1499::Write_2s_complement(int reg, int data)
{
    // Write one of the 2's complement registers
    reg = (reg & MAX1499_COMMS_RS_MASK);
    data = data & 0xFFFF; // validate the data

    const unsigned __int8 mosi[] = {
        (unsigned __int8)(MAX1499_COMMS_START | MAX1499_COMMS_RW_WRITE | reg),
        (unsigned __int8)((data >> 8) & 0xFF),
        (unsigned __int8)(data & 0xFF)
    };
    unsigned __int8 miso_buf[sizeof(mosi)];
    bool result = SPI_Transfer(sizeof(mosi), mosi, miso_buf);
    return result;
}
//-----
int MAX1499::Read_2s_complement(int reg)
{
    // Read one of the 2's complement registers
    reg = (reg & MAX1499_COMMS_RS_MASK);

    const unsigned __int8 mosi[] = {
        (unsigned __int8)(MAX1499_COMMS_START | MAX1499_COMMS_RW_READ | reg),
        (unsigned __int8)(0xFF),
        (unsigned __int8)(0xFF)
    };
    unsigned __int8 miso_buf[sizeof(mosi)];
    bool result = SPI_Transfer(sizeof(mosi), mosi, miso_buf);
    if (result == false) {
        return 0; // failure
    }
    int data = miso_buf[1] * 0x100 + miso_buf[2];
    if (data >= 32768) {
        data -= 65536;
    }
    if (data >= 32768) {
        data -= 65536;
    }
    return data;
}
//-----
bool MAX1499::Write_8bit_reg(int reg, int data)
{
    // Write one of the 8 bit registers
    reg = (reg & MAX1499_COMMS_RS_MASK);
    const unsigned __int8 mosi[] = {
        (unsigned __int8)(MAX1499_COMMS_START | MAX1499_COMMS_RW_WRITE | reg),
        (unsigned __int8)(data & 0xFF)
    };
    unsigned __int8 miso_buf[sizeof(mosi)];
    bool result = SPI_Transfer(sizeof(mosi), mosi, miso_buf);
    return result;
}
//-----
int MAX1499::Read_8bit_reg(int reg)
{
    // Read one of the 8 bit registers
    reg = (reg & MAX1499_COMMS_RS_MASK);
```

Listing 2 (Sheet 3 of 4)

# MAX1499 Evaluation Kit/MAX1499 Evaluation System

Evaluate: MAX1498/MAX1499

```
const unsigned __int8 mosi[] = {
    (unsigned __int8)(MAX1499_COMMS_START | MAX1499_COMMS_RW_READ | reg),
    (unsigned __int8)(0xFF)
};
unsigned __int8 miso_buf[sizeof(mosi)];
bool result = SPI_Transfer(sizeof(mosi), mosi, miso_buf);
if (result == false) {
    return 0; // failure
}
int data = miso_buf[1];
return data;
}
//-----
```

Listing 2 (Sheet 4 of 4)

Maxim cannot assume responsibility for use of any circuitry other than circuitry entirely embodied in a Maxim product. No circuit patent licenses are implied. Maxim reserves the right to change the circuitry and specifications without notice at any time.

24 \_\_\_\_\_ Maxim Integrated Products, 120 San Gabriel Drive, Sunnyvale, CA 94086 408-737-7600