

# M54128L/FP

## EARTH LEAKAGE CURRENT DETECTOR

### DESCRIPTION

The M54128 is a semiconductor integrated circuit designed for high-speed type earth leakage breakers. This IC includes leakage and abnormal voltage detecting functions.

### FEATURES

- Improvement of ability against unwanted tripping due to lightning -surge.
  - Adopt the two times counting system.
  - Improvement of ability against needless action due to lightning-impulse.
- It is a possible that cope with IEC owing to mode change.
  - Adopt the 1.5 times counting system.
- High input impedance :
  - Filter circuit can be formed with externally attached C/R.
  - Improvement of ability against needless action due to high frequency and high harmonics.
- High input sensitivity :  $V_T = 6.5mV_{rms}$
- Abnormal voltage detecting (neutral conductor open-phase protection) function :
  - Neutral conductor open-phase protection at single-phase three-wire system
  - In case of no use this function, stop this function and reduction of circuit current, possible.
- Low voltage operation : 7 to12V (conventional Mitsubishi ICs : 12 to 20V)
- Low current dissipation :
  - In stand-by condition :  $820\mu A$  typical ( $V_s = 9V, T_a = 25^\circ C$ )
  - When SCR is ON :  $740\mu A$  typical ( $V_s = 9V, T_a = 25^\circ C$ )
- Highly stable design : Employment of circuits of which characteristics fluctuations resulting from changes in supply voltage/ambient temperature are small.

### APPLICATION

Earth leakage breaker

### RECOMMENDED OPERATING CONDITIONS

Supply voltage range .....7 to12V  
 Operating ambient temperature ..... -20 to +85°C

### PIN CONFIGURATION (TOP VIEW)

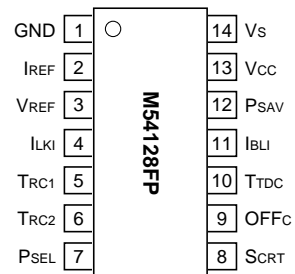

Outline 14P2N-A

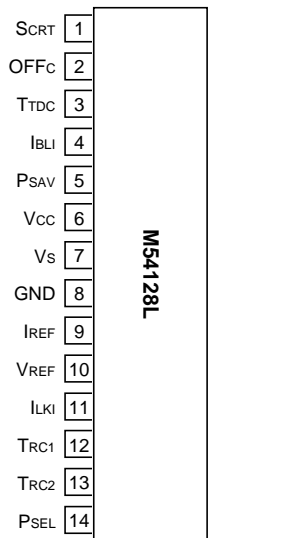

Outline 14P5A

### BLOCK DIAGRAM

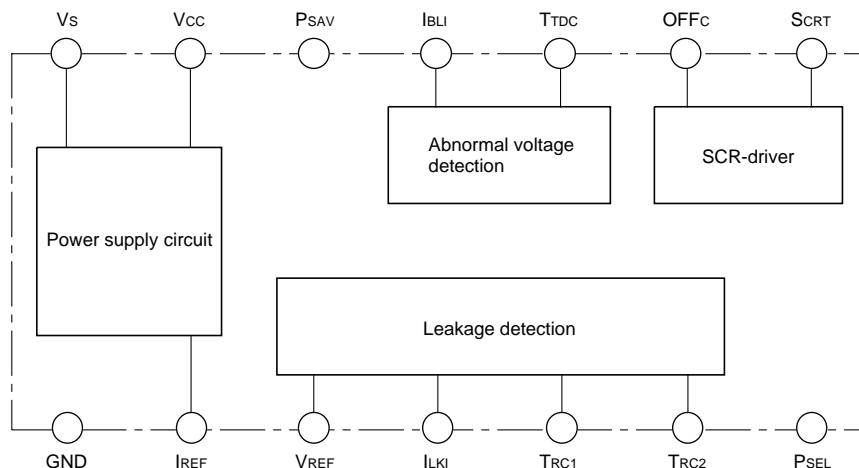

# M54128L/FP

## EARTH LEAKAGE CURRENT DETECTOR

### PIN FUNCTION DESCRIPTION

Pin No.		Pin name	Function
L	FP		
<b>Common</b>			
⑦	⑭	V <sub>S</sub>	Power supply
⑥	⑬	V <sub>CC</sub>	Output pin of internal constant-voltage circuit. Connects to capacitor for decoupling.
⑨	②	IREF	Connects to resistor which sets constant current of each internal circuit. Approx. 1.3V.
⑧	①	GND	Grounding
⑤	⑫	PSAV	When in normal use, connect the pin to V <sub>CC</sub> pin. When the abnormal voltage detection function is not in use, ground the pin. Circuit current can be reduced. Ground IBLI pin and TTDC pin also.
<b>Leakage detection, abnormal voltage detection, SCR drive circuits</b>			
⑩	③	VREF	Input reference level pin of the leakage detection circuit. Approx. 2.7V.
⑪	④	ILKI	Another input pin of the leakage detection circuit.
⑫	⑤	TRC1	Connects to capacitor for integrating output signals of the leakage input signal level discriminator.
⑬	⑥	TRC2	Connects to condenser for removing noise.
⑭	⑦	PSEL	Logic function switching pin used when detecting leakage. When the pin is grounded, SCRT operates with the logic flow of negative input → positive input → negative input. When it is connected to V <sub>CC</sub> pin, SCRT operates with the logic flow of negative input → positive input.
②	⑨	OFFC	This IC will be restored to the initial condition after the specified period if : leakage input signal does not continue ; abnormal voltage input signal does not continue ; or leakage/abnormal voltage is detected and SCR becomes ON. The pin connects to capacitor for time setting of this function.
④	⑪	IBLI	Input pin of the abnormal voltage detection circuit.
③	⑩	TTDC	Connects to capacitor for time setting of the abnormal voltage detection circuit.
①	⑧	SCRT	Output pin for drive a SCR.

# M54128L/FP

## EARTH LEAKAGE CURRENT DETECTOR

### I/O EQUIVALENT CIRCUIT

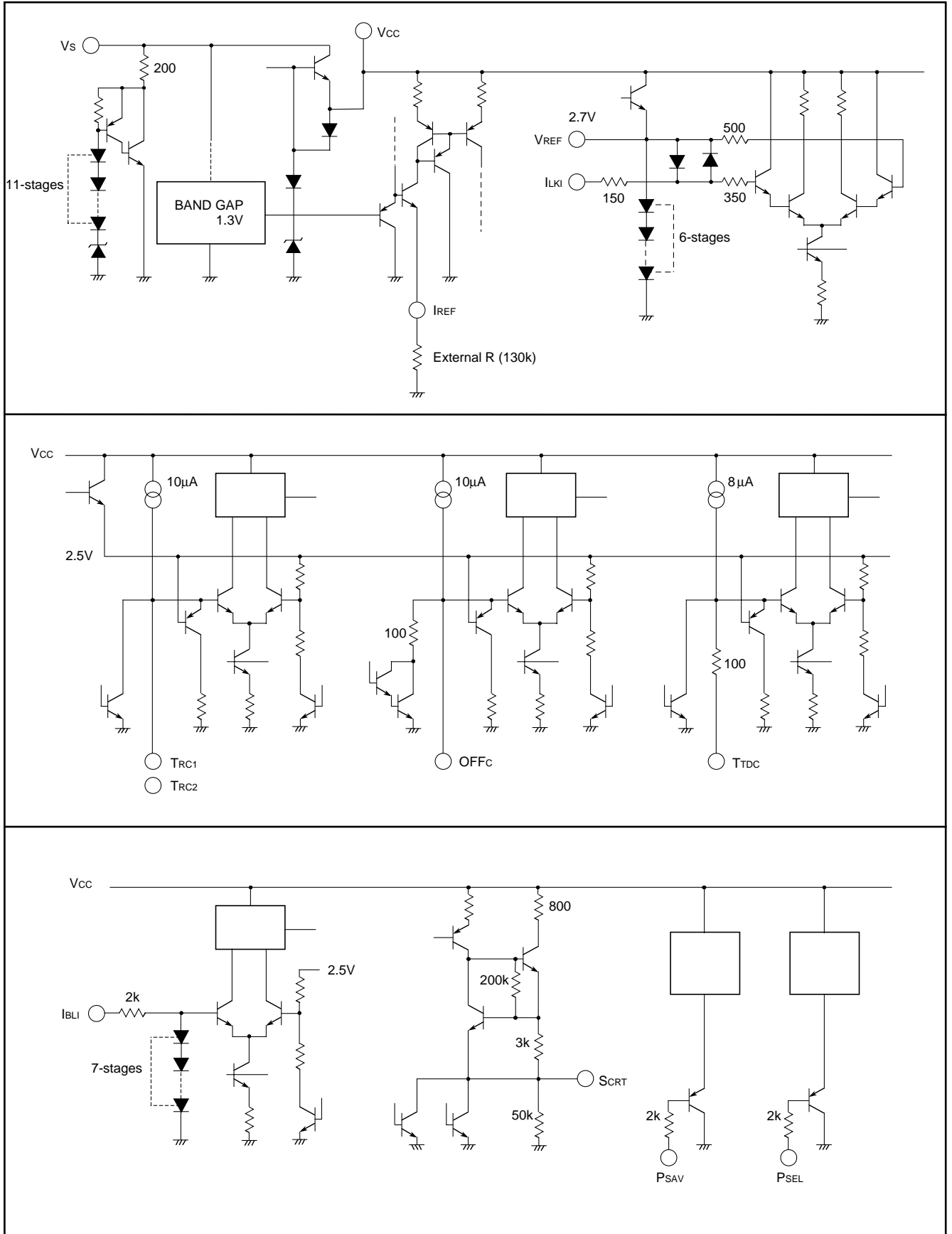

# M54128L/FP

## EARTH LEAKAGE CURRENT DETECTOR

### ABSOLUTE MAXIMUM RATINGS (Ta = 25°C, unless otherwise noted)

Symbol	Parameter	Conditions	Ratings	Unit
Is	Source current		4	mA
Vs MAX	Max. supply voltage		15	V
$\Delta V_{IL}$	Input voltage	ILKI - VREF	-1.4 to +1.4	V
IIL	Input current	ILKI - VREF	-5 to +5	mA
IIG	Input current	VREF - GND	10	mA
VIBL	Input voltage	IBLI - GND	-0.3 to +4.0	V
IIBL	Input current	IBLI - GND	4	mA
Pd	Power dissipation		200	mW
Topr	Operating temperature		-20 to 85	°C
Tstg	Storage temperature		-55 to 125	°C

### TYPICAL CHARACTERISTICS

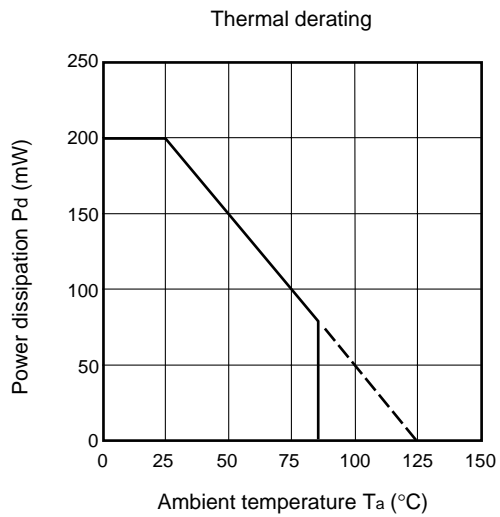

**ELECTRICAL CHARACTERISTICS** (Ta = 25°C, unless otherwise noted)

Symbol	Parameter		Vs	Test conditions	Limits			Unit	
					Min.	Typ.	Max.		
Is0	Power supply circuit	Source current: In stand-by condition	9V	PSAV = VCC	570	820	950	μA	
Is1		Source current: While detecting leakage			570	840	950	μA	
Is2		Source current: While detecting abnormal voltage			570	810	950	μA	
Is3		Source current: Immediately after driving of SCR			520	740	870	μA	
Is0'		Source current: In stand-by condition	9V	PSAV = GND	520	740	870	μA	
Is1'		Source current: While detecting leakage			520	760	870	μA	
Is3'		Source current: Immediately after driving of SCR			520	740	870	μA	
–		ISO variation with ambient temperature	9V	Ta = -20 to 85°C	–	-0.07	–	%/°C	
Vs max		Maximum current voltage	–	Is = 4mA	–	13.9	15	V	
Vion	Leakage detection circuit	Leakage detecting DC input voltage	9V	ILKI - VREF	–	±7.5	–	mVdc	
IiH		ILKI pin input bias current		VIN = VREF	–	2	15	nA	
VO		VREF pin output voltage		–	2.7	–	V		
VILKI		ILKI-VREF input clamp voltage		ILKI = ±3mA	–	±1.2	–	V	
VRCL		VREF-GND clamp voltage		IRCL = 5mA	–	4.6	–	V	
EIOH	2ms circuit	TRC1 pin "H" output current precision	9V	Vo = 0V : IOH = -10.4μA	-20	–	20	%	
VTH		TRC1 threshold voltage		–	2.4	–	V		
ETW1		TW1 pulse width precision		C = 0.01μF : TW1 = 2.3ms	-15	–	15	%	
–		TW1 variation with ambient temperature		Ta = -20 to 85°C	–	-0.06	–	%/°C	
EIOH	1ms circuit	TRC2 pin "H" output current precision	9V	Vo = 0V : IOH = -10.4μA	-20	–	20	%	
VTH		TRC2 threshold voltage		–	2.4	–	V		
ETW2		TW2 pulse width precision		C = 0.0047μF : TW2 = 1.1ms	-15	–	15	%	
–		TW2 variation with ambient temperature		Ta = -20 to 85°C	–	-0.06	–	%/°C	
Vt	Total leakage detecting AC voltage	VT variation with ambient temperature	9V	60Hz	–	6.5	–	mVrms	
–			9V	Ta = 25 → 85°C	–	-4.0	–	%	
–	–	–	9V	Ta = 25 → -20°C	–	-4.0	–	%	
VBLT	Abnormal voltage detecting circuit	Abnormal voltage detecting voltage	9V		2.2	2.4	2.6	V	
–		VBLT variation with supply voltage	–		–	0.01	–	%/V	
–		VBLT variation with ambient temperature	–	Ta = -20 to 85°C	–	0.06	–	%/°C	
IIBLT		IBLI pin input bias current	9V	VIN = VREF	–	120	300	nA	
VIBLC		IBLI-GND clamp voltage		IIN = 1mA	–	7.2	–	V	
EIOH		TTDC pin "H" output current precision	9V	Vo = 0V : IOH = -8μA	-20	–	20	%	
VTH		TTDC threshold voltage		–	2.4	–	V		
ETW4		Delay time pulse width precision		C = 1.0μF : TW4 = 300ms	-30	–	30	%	
EIOH	Reset circuit	OFFC pin "H" output current precision	9V	Vo = 0V : IOH = -10μA	-20	–	20	%	
VTH		OFFC threshold voltage		–	2.4	–	V		
ETW3		Reset timer pulse width precision		C = 0.33μF : TW3 = 55ms	-30	–	30	%	
VOL8	SCR drive circuit	SCRT pin "L" output voltage	9V	IoL = 200μA	–	0.1	0.2	V	
IOHc		SCRT pin "H" output current	9V	Vo = 0.8V	Ta = -20°C	-200	-260	–	μA
IOHn					Ta = 25°C	-100	-220	–	μA
IOHh					Ta = 85°C	-70	-180	–	μA
Vsoff	IOH holding supply voltage	–		–	3.0	4.5	V		

# M54128L/FP

## EARTH LEAKAGE CURRENT DETECTOR

### EARTH LEAKAGE DETECTION

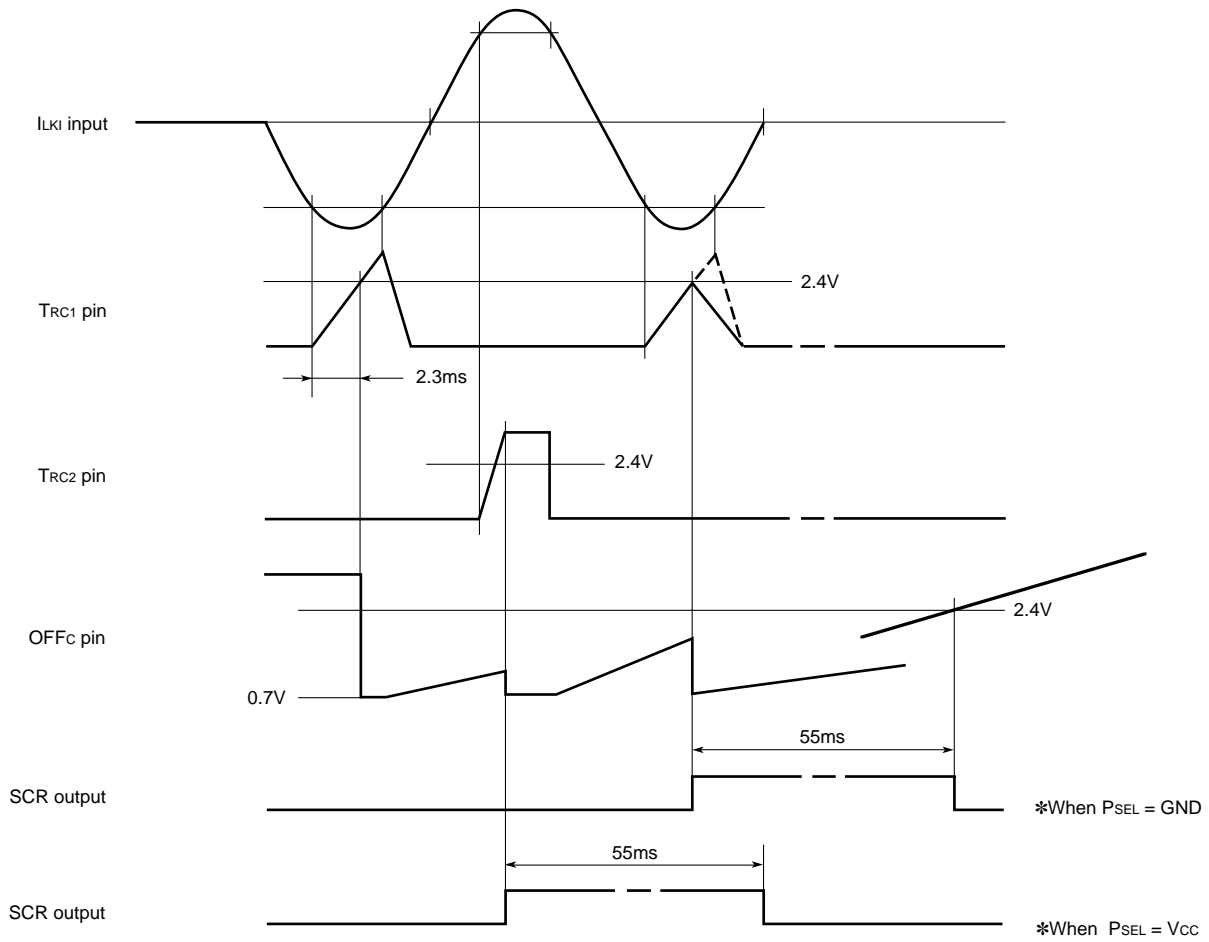

### ABNORMAL VOLTAGE DETECTION

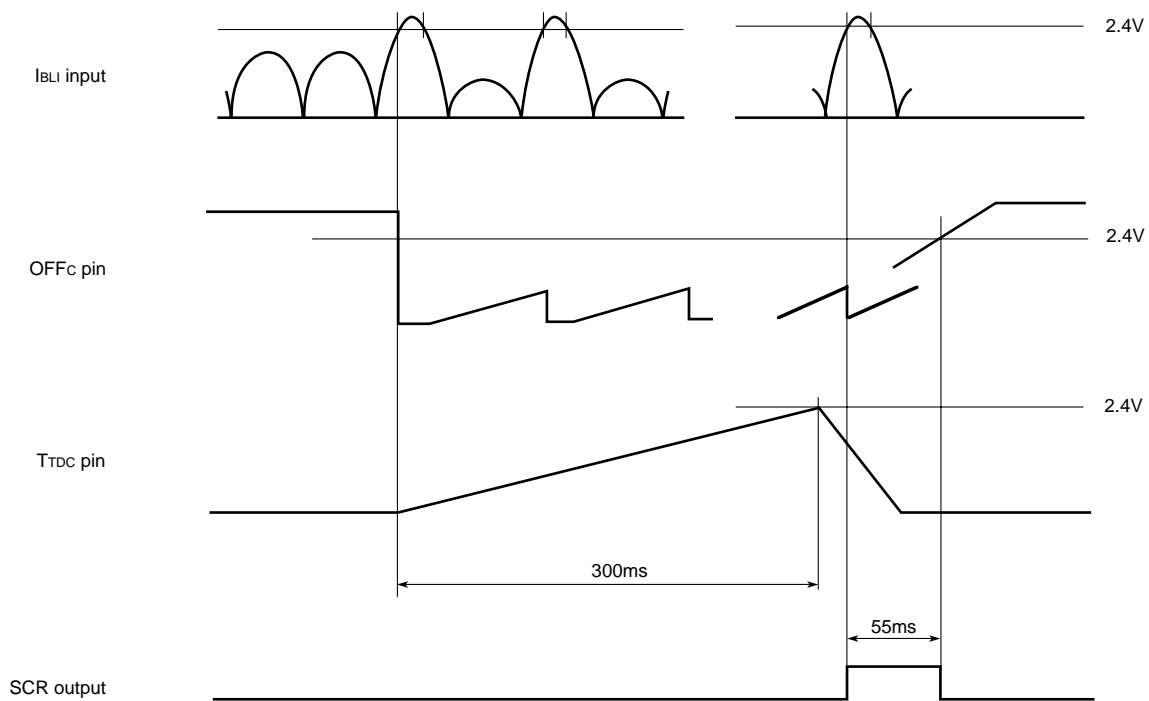

**PRECAUTIONS FOR APPLICATION**

Note that the improvement examples in the following precautions for application of M54128FP/L are merely examples.

**1. VS applied voltage**

- (1) Is circuit current (clamp circuit characteristics of the equivalent circuit) is as shown in TYPICAL CHARACTERISTICS figure 1 on page 9. Attention should be given to the circuit current when designing the power supply circuit.

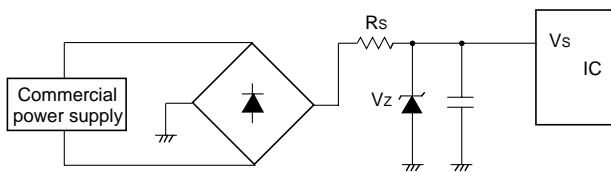

- (2) Use of the IC by rectifying commercial power supply  
 a) As Vz, be sure to use zener diode of 12V or less (not exceeding the absolute maximum rating of 15V).  
 b) At high temperatures, clamp voltage decreases and Is increases. Increase of Is will be restricted at Rs, however.
- (3) If normal DC power supply is used, use the IC at Vs=7to10V.

**2. Resistor of IREF pin (R = 130kΩ)**

Reference constant current source of the IC (for restraining fluctuations in supply voltage characteristics and ambient temperature characteristics).

Since this resistor determines the characteristics of each circuit, use of high-precision resistor ( $\pm 2\%$ ) is recommended.

**3. Layout of printed circuit board**

External noise (noise simulator etc.) may cause faulty operation of the IC.

To improve the noise immunity, layout the printed circuit board so that the wiring of the external C and R is made as short as possible.

Special attention should be given to the wiring of the condensers connected to Vs, Vcc and SCRT pins.

**4. Be careful that the voltage of SCRT output pin does not become lower than the GND level.****5. Change in sensitivity due to insulation deterioration**

If the insulation of ZCT input pin from the high voltage part might deteriorate, improvement might be expected by connecting a resistor of about R=100kΩ between VREF pin and GND.

It should be noted that the circuit current will increase at  $I \approx 2.7V/R$  (approx.).

**6. Clamp diode of IBLI input pin**

As shown in the equivalent circuit, it is made up of series resistor (approx. 2kΩ) and seven stages of forward diode.

- (1) At high temperatures, the drop in diode Vf may decrease the clamp voltage of the pin. If the voltage approaches the reference level of the comparator (2.4V) and current leaks occur, the overvoltage detection level may slightly fluctuate. Form the detection circuit as the figure below. It is recommended that R1, R2 and Vz be set as shown below.

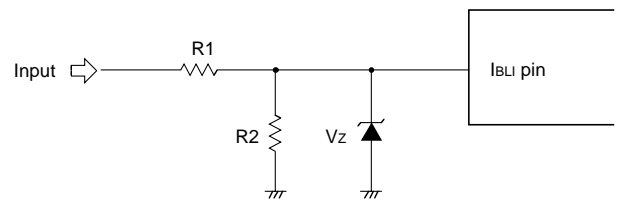

$$\bullet R_1 + R_2 > 200k\Omega$$

$$\bullet \frac{R_1 \times R_2}{R_1 + R_2} < 7k\Omega$$

- (2) During excessive input, as shown above, setting should be made so that the input pin voltage becomes 4.3V or lower (to prevent the saturated comparator circuit from operating).  
 $\bullet V_z \approx 4.0V$

# M54128L/FP

## EARTH LEAKAGE CURRENT DETECTOR

### 7. Reset time in reset circuit

This circuit is designed as a timer circuit of  $V_L = 0.7V$ ,  $V_H = 2.5V$  and  $I_o = 10\mu A$ . When SCR is ON, the power supply route of the leakage detection and abnormal voltage detection circuits are shut off,  $V_L$  does not drop to  $0.7V$  as shown below and therefore reset time may become shorter.  
Set the reset time somewhat longer in advance.

$$T = \frac{C \times (V_H - V_L)}{I} = \frac{0.33\mu F \times (2.4 - 0.7)}{10\mu A} \approx 55ms$$

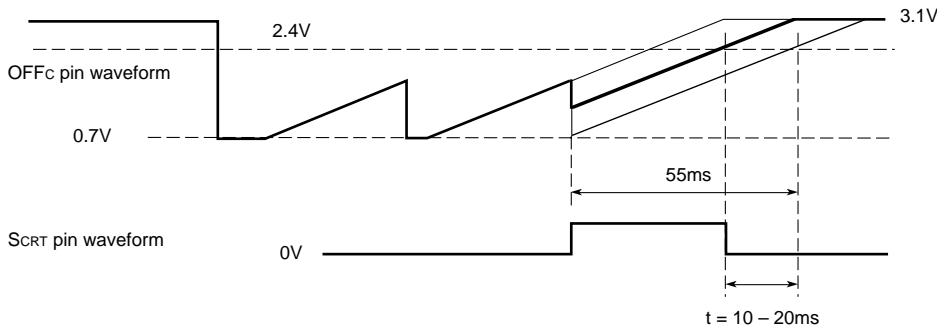

- In the case of leakage detection :  
May become 10ms (50Hz) shorter
- In the case of abnormal voltage detection :  
May become 20ms (50Hz) shorter

Note. t : time shorter than setting value

### 8. Application of leakage detection function to time delay function

As shown in the figure below, by applying the neutral conductor open-phase protection function, it is possible to provide the leakage detection function with time delay function (several 100ms). In this case, however, the neutral conductor open-phase protection function disappears. Pin No. in parentheses are of L type.

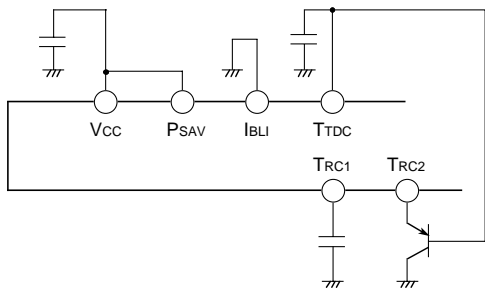

(Example 1)

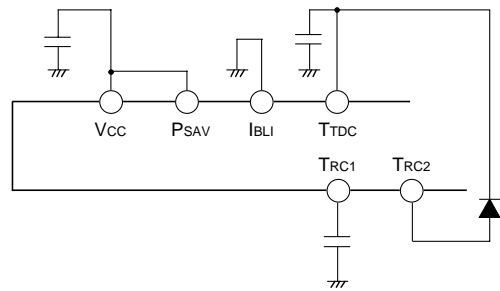

(Example 2)



**TYPICAL CHARACTERISTICS**

Source Current vs. Supply Voltage

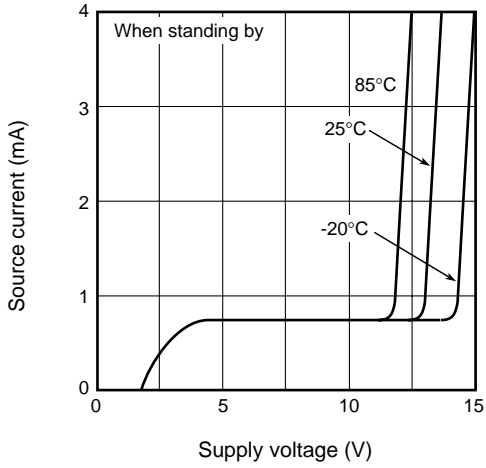

Source Current vs. Supply Voltage

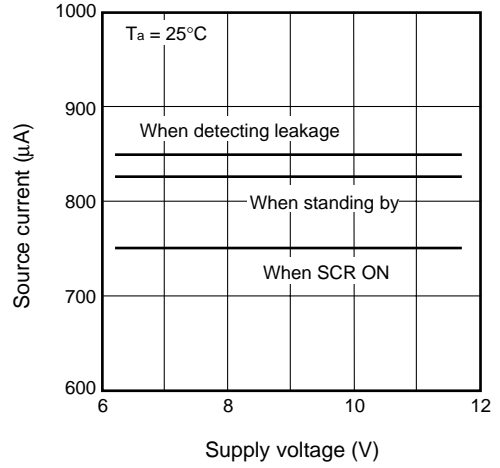

Source Current vs. Ambient Temperature

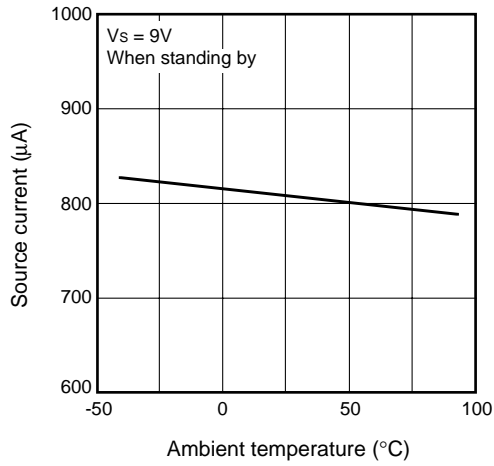

Source Current vs. Ambient Temperature

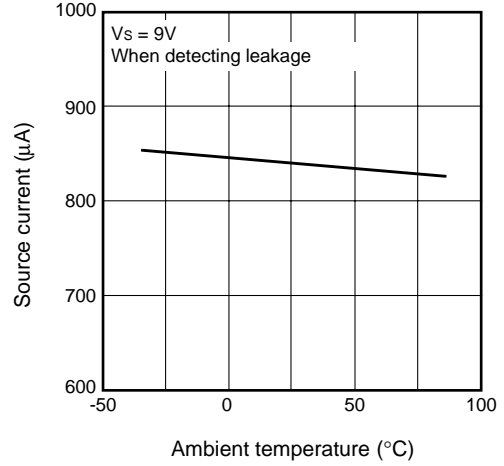

Source Current vs. Ambient Temperature

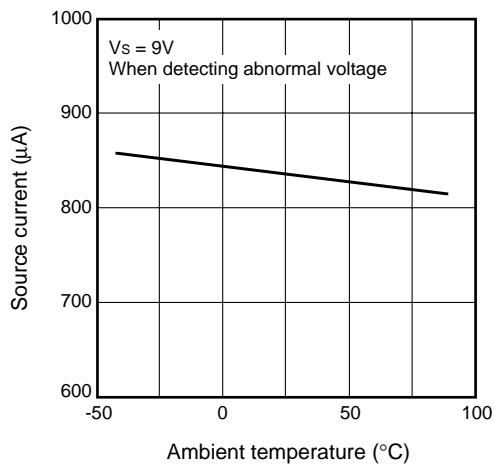

Source Current vs. Ambient Temperature

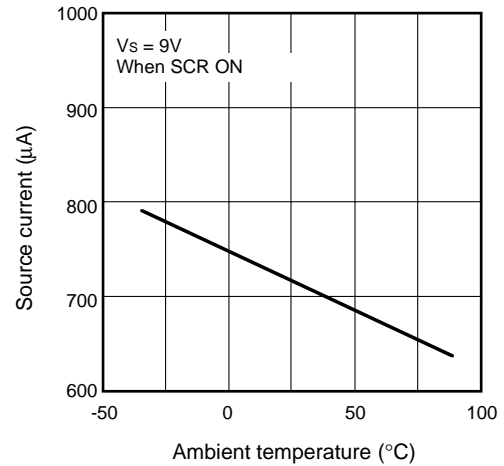

IREF Output Voltage vs. Supply Voltage

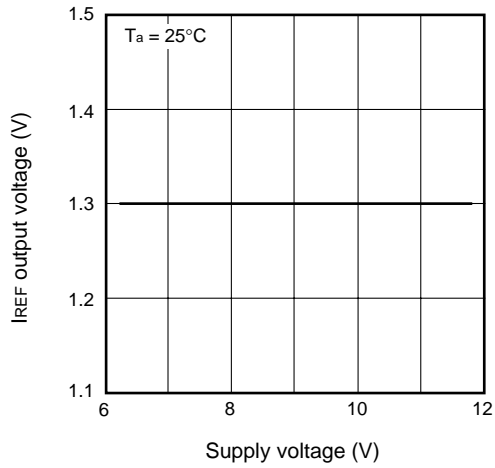

IREF Output Voltage vs. Ambient Temperature

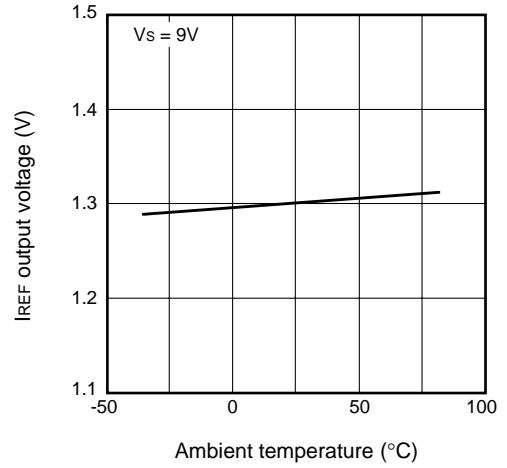

VREF Output Voltage vs. Supply Voltage

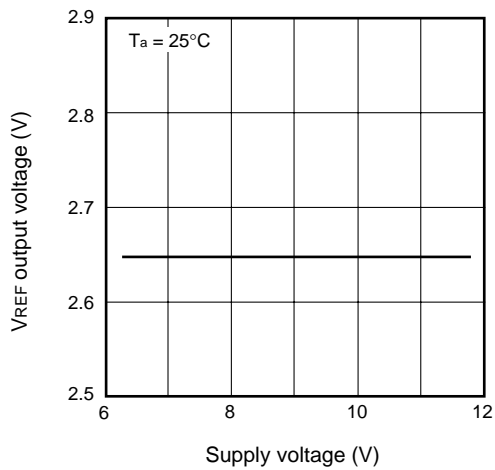

VREF Output Voltage vs. Ambient Temperature

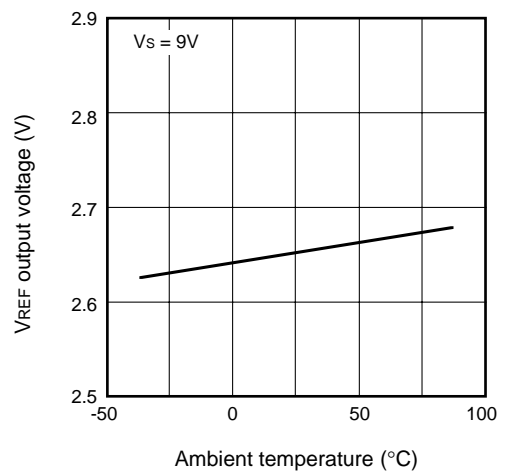

Vcc Output Voltage vs. Supply Voltage

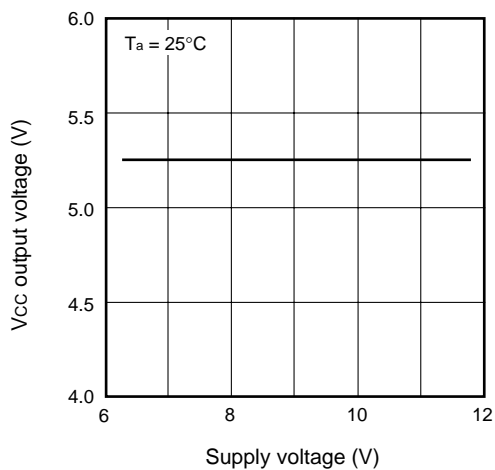

Vcc Output Voltage vs. Ambient Temperature

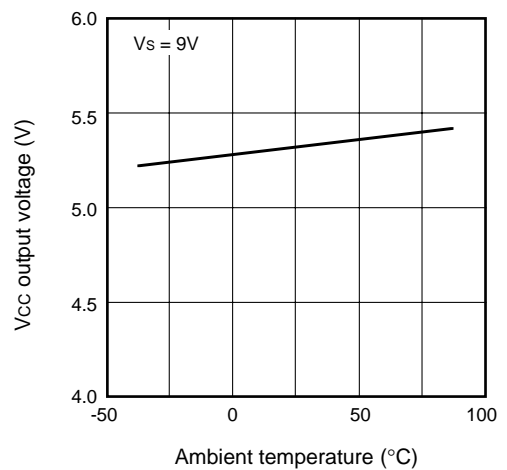

# M54128L/FP

## EARTH LEAKAGE CURRENT DETECTOR

TRC1,2 "H" Output Current vs. Supply Voltage

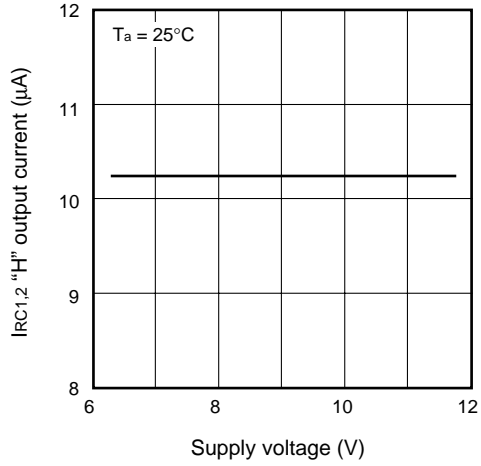

TRC1,2 "H" Output Current vs. Ambient Temperature

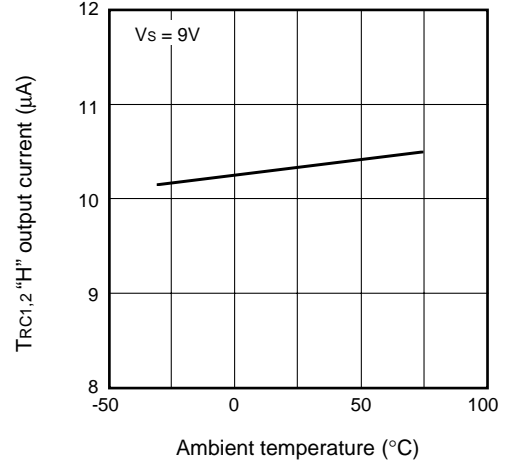

TRC1,2/OFFC/IBLI/TDC Threshold Voltage vs. Supply Voltage

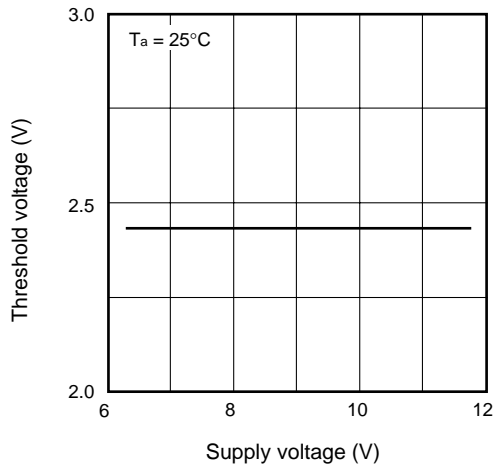

TRC1,2/OFFC/IBLI/TDC Threshold Voltage vs. Ambient Temperature

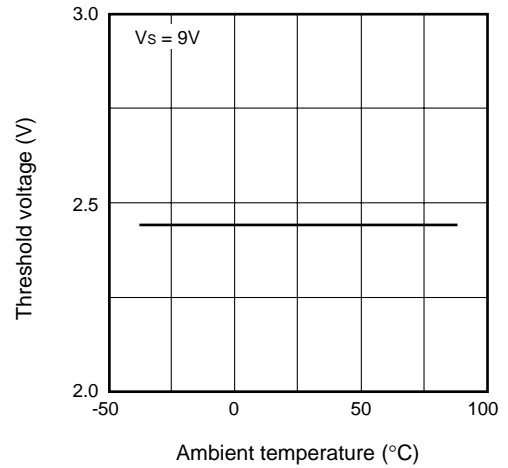

TRC1 Pulse Width vs. Supply Voltage

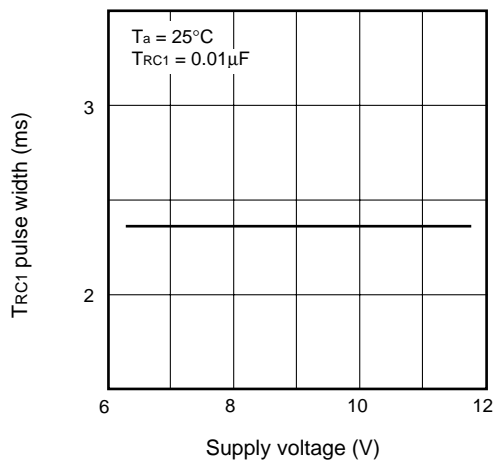

TRC1 Pulse Width vs. Ambient Temperature

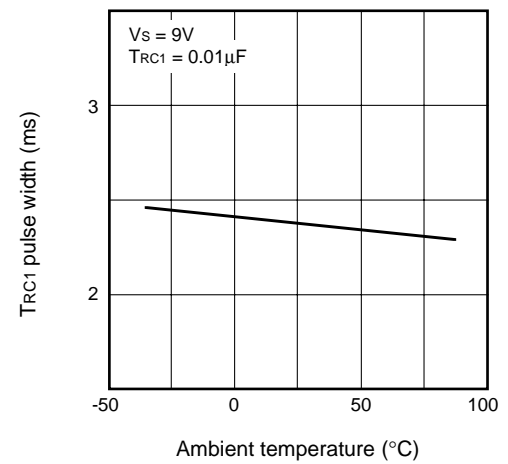

# M54128L/FP

## EARTH LEAKAGE CURRENT DETECTOR

Total Leakage Detection AC Voltage vs. Supply Voltage

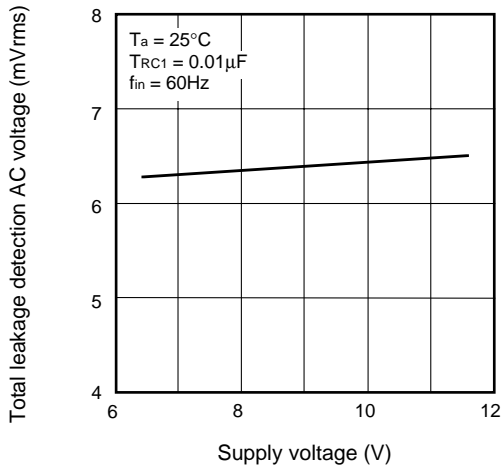

Total Leakage Detection AC Voltage vs. Ambient Temperature

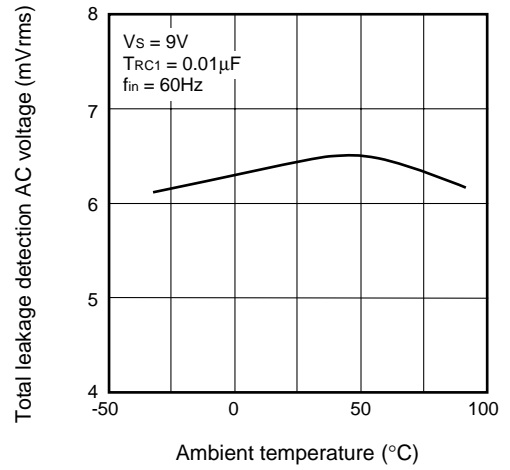

T<sub>TDC</sub> "H" Output Current vs. Supply Voltage

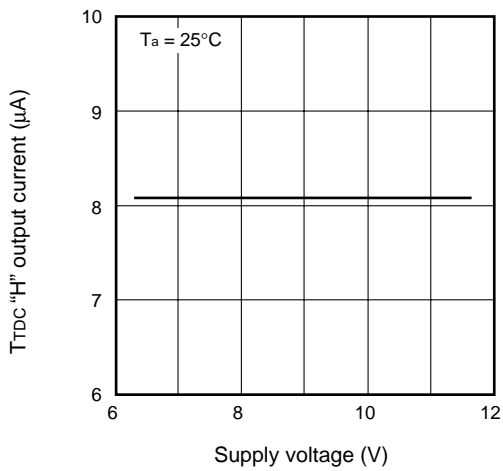

T<sub>TDC</sub> "H" Output Current vs. Ambient Temperature

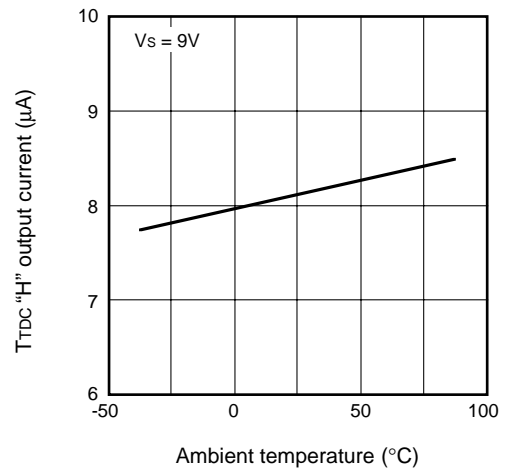

T<sub>TDC</sub> Pulse Width vs. Supply Voltage

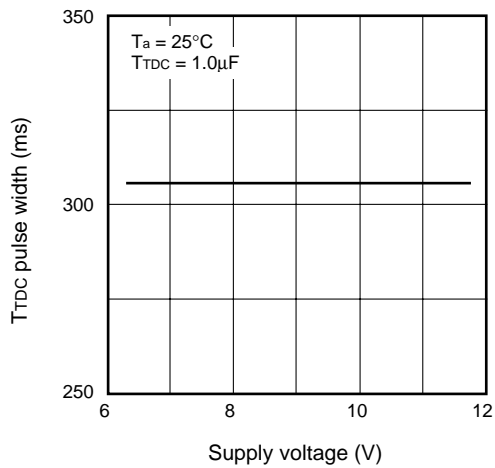

T<sub>TDC</sub> Pulse Width vs. Ambient Temperature

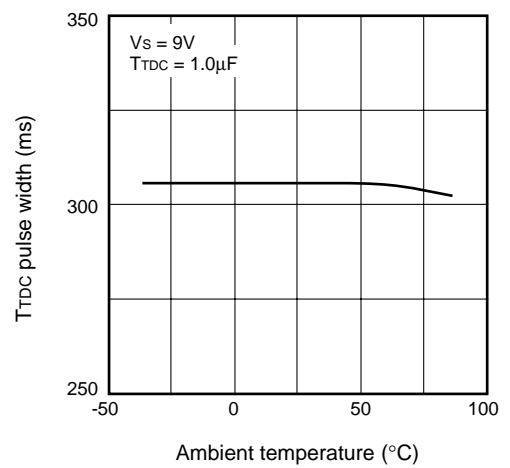

# M54128L/FP

## EARTH LEAKAGE CURRENT DETECTOR

OFFc "H" Output Current vs. Supply Voltage

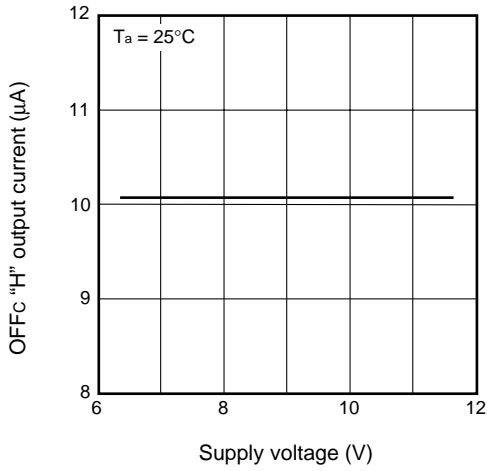

OFFc "H" Output Current vs. Ambient Temperature

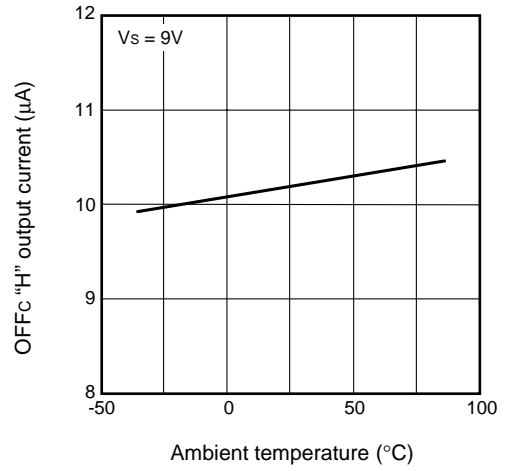

OFFc "L" Output Voltage vs. Supply Voltage

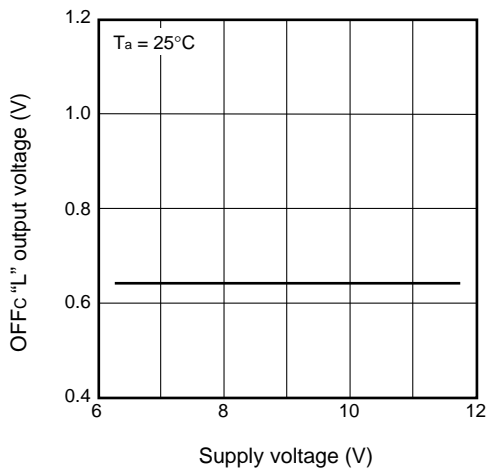

OFFc "L" Output Voltage vs. Ambient Temperature

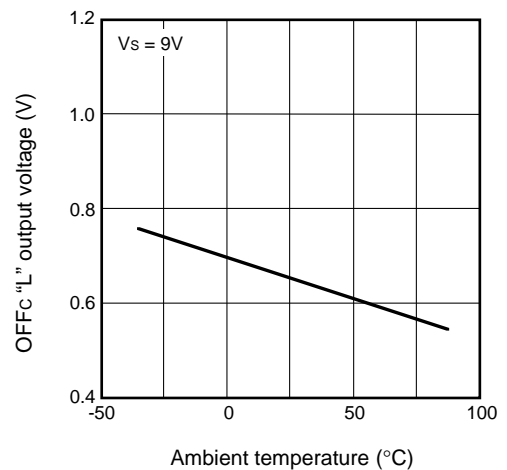

OFFc Pulse Width vs. Supply Voltage

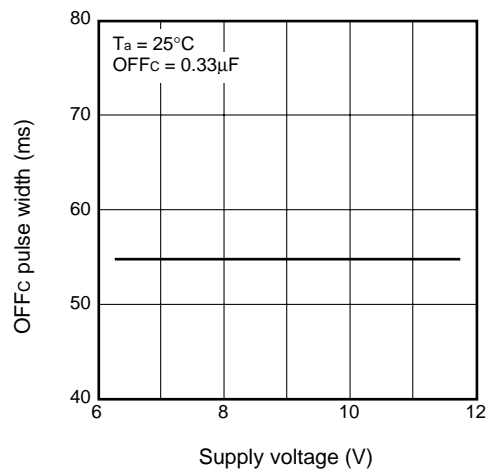

OFFc Pulse Width vs. Ambient Temperature

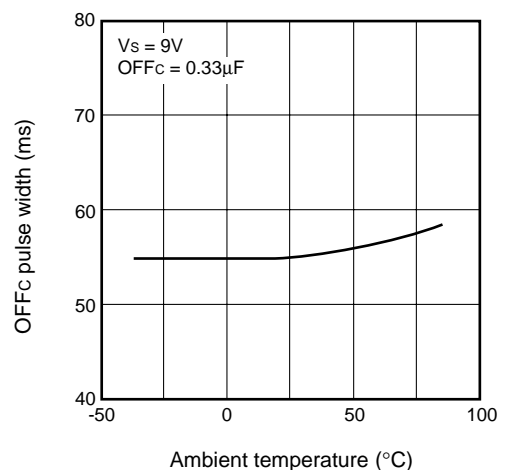

SCRT "L" Output Voltage vs. "L" Output Current

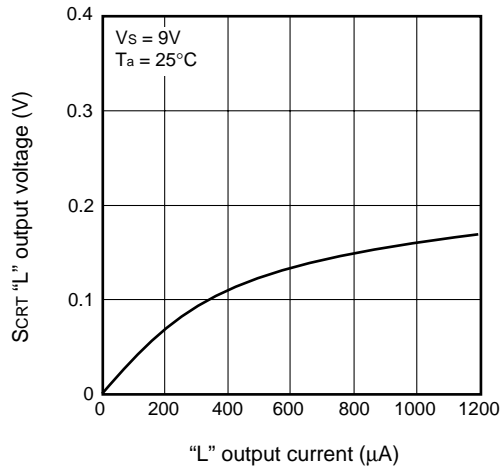

SCRT "L" Output Voltage vs. "L" Supply Voltage

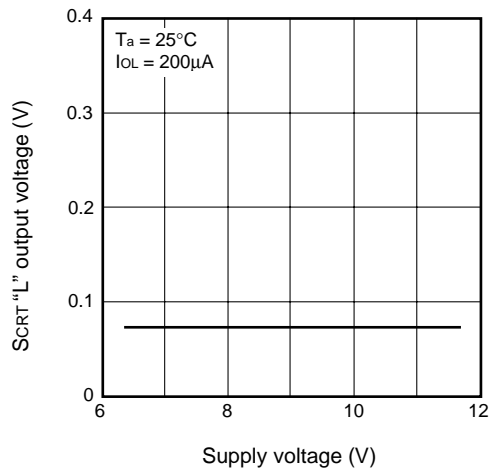

SCRT "L" Output Voltage vs. Ambient Temperature

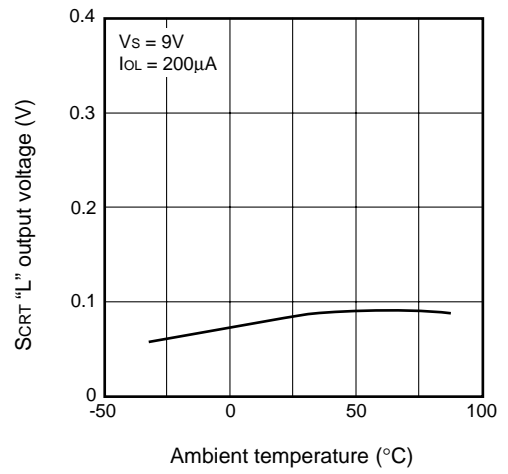

SCRT "H" Output Current vs. Supply Voltage

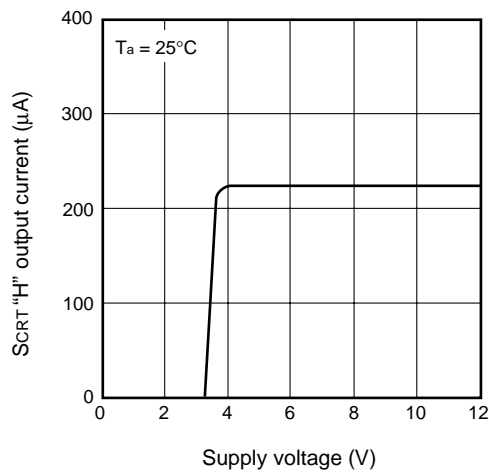

SCRT "H" Output Current vs. Ambient Temperature

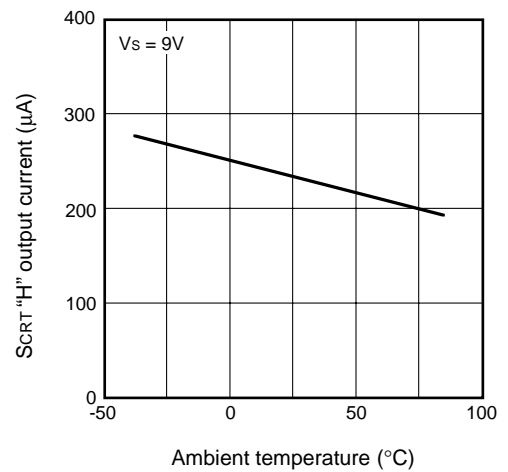

# M54128L/FP

## EARTH LEAKAGE CURRENT DETECTOR

### APPLICATION EXAMPLE

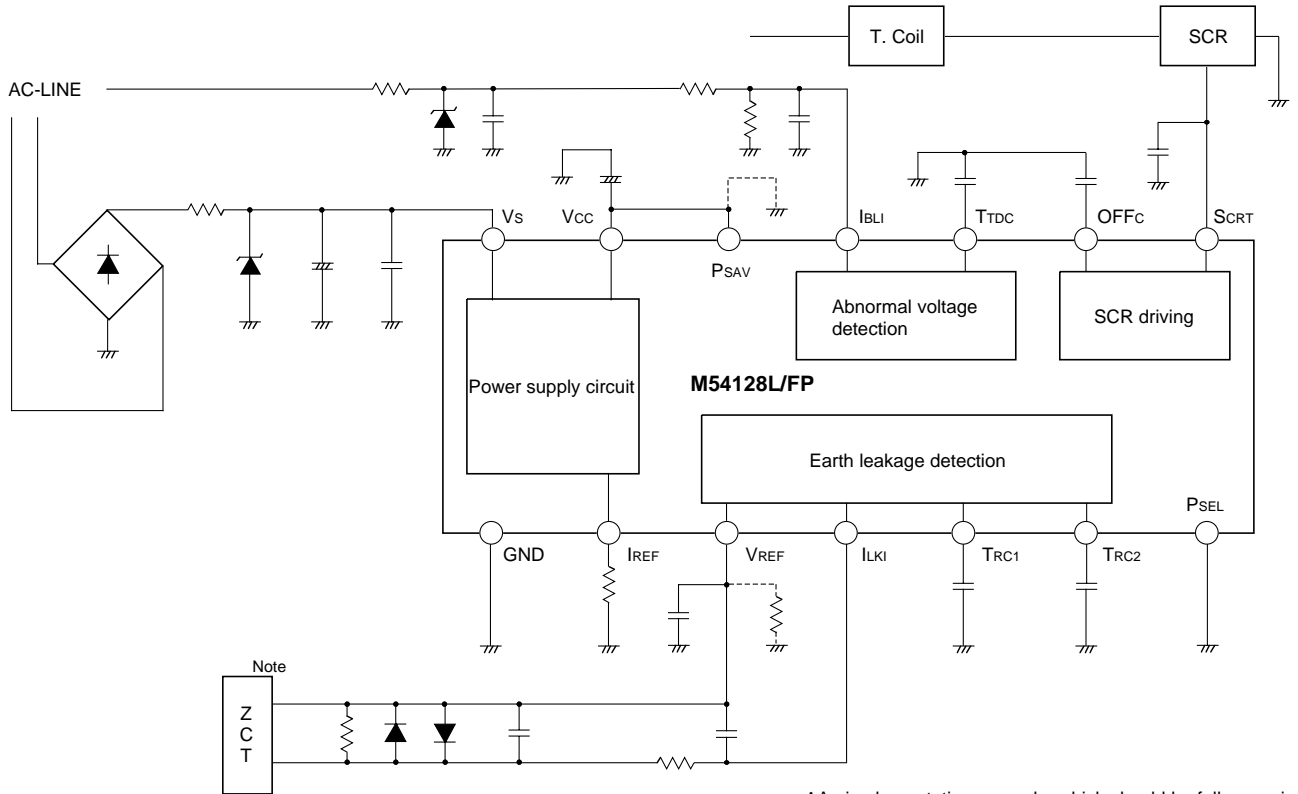

\*An implementation example, which should be fully examined.

Note : MZ Core Series by Soryo Denshi Kagaku Co., Ltd (Mitsubishi Subsidiary)  
Tel. +81-427-74-7813