

Single chip analog signal processor for facsimiles

BH8220KS

The BH8220KS is a single-chip analog signal processing IC developed for facsimiles with telephone answering machines.

●Applications

Facsimiles and facsimiles with telephone answering machines

●Features

- 1) Cross-point mixer with nine inputs and eight outputs.
- 2) Internal electronic volume.
- 3) Internal ALC and VOX circuits.
- 4) Accommodates no-ringing reception.

●Absolute maximum ratings (Ta = 25°C)

Parameter	Symbol	Limits	Unit
Power supply voltage	V _{CC}	9	V
Power dissipation	P _d	500*1	mW
Operating temperature	T _{opr}	-25~+75	°C
Storage temperature	T _{stg}	-55~+125	°C

*1 Reduced by 5mW for each increase in Ta of 1°C over 25°C.

●Recommended operating conditions (Ta = 25°C)

Parameter	Symbol	Min.	Typ.	Max.	Unit
Power supply voltage	V _{CC}	4.5	—	5.5	V

● Block diagram

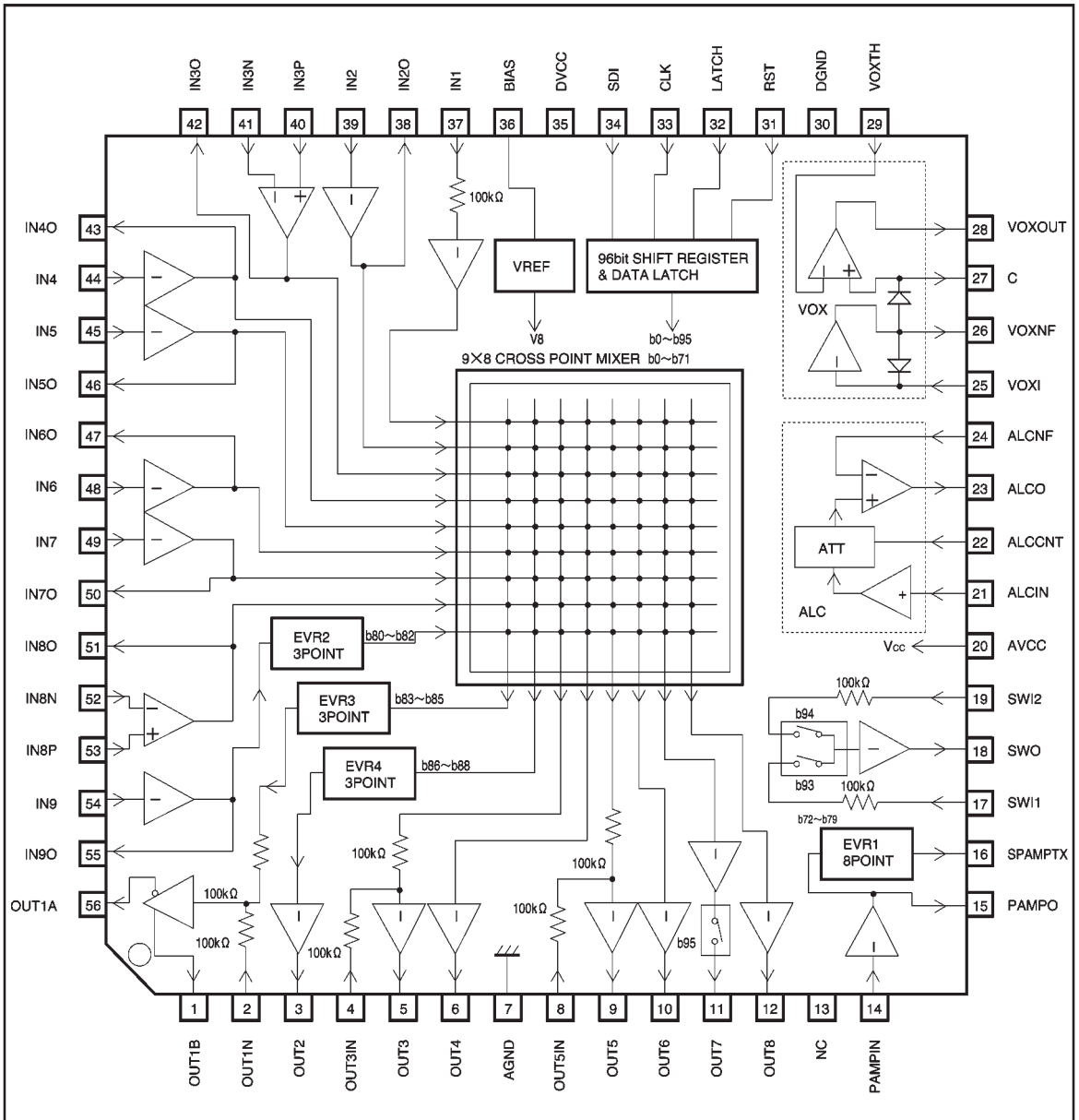

● Pin descriptions

Pin No.	Pin name	Function
1	OUT1B	Output 1B
2	OUT1IN	Output 1 mixing input
3	OUT2	Output 2
4	OUT3IN	Output 3 mixing input
5	OUT3	Output 3
6	OUT4	Output 4
7	AGND	Analog GND
8	OUT5IN	Output 5
9	OUT5	Output 5 mixing input
10	OUT6	Output 6
11	OUT7	Output 7
12	OUT8	Output 8
13	N. C.	No connection
14	PAMP IN	SP EVR AMP input
15	PAMPO	SP EVR AMP feedback output
16	SPAMPTX	SP EVR AMP output
17	SWI1	Switch input 1
18	SWO	Switch output
19	SWI2	Switch input 2
20	AVCC	Analog V _{cc}
21	ALCIN	ALC input
22	ALCCNT	ALC control
23	ALCO	ALC output
24	ALCNF	ALC feedback output
25	VOXI	VOX input
26	VOXNF	VOX AMP feedback output
27	C	VOX constant setting
28	VOXOUT	VOX output

Pin No.	Pin name	Function
29	VOXTH	VOX detection level setting
30	DGND	Digital GND
31	RST	Reset pin
32	LATCH	Latch signal input
33	CLK	Clock input
34	SDI	Serial data input
35	DVCC	Digital V _{cc}
36	BIAS	Bias pin
37	IN1	Input 1
38	IN2O	Input 2 feedback output
39	IN2	Input 2
40	IN3P	Input 3 (non-reversed input)
41	IN3N	Input 3 (reversed input)
42	IN3O	Input 3 feedback output
43	IN4O	Input 4 feedback output
44	IN4	Input 4
45	IN5	Input 5
46	IN5O	Input 5 feedback output
47	IN6O	Input 6 feedback output
48	IN6	Input 6
49	IN7	Input 7
50	IN7O	Input 7 feedback output
51	IN8O	Input 8 feedback output
52	IN8N	Input 8 (reversed input)
53	IN8P	Input 8 (non-reversed input)
54	IN9	Input 9
55	IN9O	Input 9 feedback output
56	OUT1A	Output 1A output

- Electrical characteristics (unless otherwise noted, $T_a = 25^\circ\text{C}$, $V_{\text{CC}} = 5\text{V}$, $f = 1\text{kHz}$, 400Hz to 30kHz using band pass filter)

Parameter	Symbol	Min.	Typ.	Max.	Unit	Conditions
Supply current	I _{CC}	8	11	14	mA	With no signal
Bias pin voltage	V _B	2.3	2.5	2.7	V	
Logic input high level voltage	V _{IH}	0.8V _{CC}	—	V _{CC}	V	SDI, CLK, RST, LATCH pins
Logic input low level voltage	V _{IL}	0	—	0.2V _{CC}	V	SDI, CLK, RST, LATCH pins
Logic input high level current	I _{IH}	—5	0	5	μA	SDI, CLK, RST, LATCH pins
Logic input low level current	I _{IL}	—5	0	5	μA	SDI, CLK, RST, LATCH pins
CLK frequency	f _{CLK}	—	—	100	kHz	DUTY=50%
Data setup time	t _{su}	250	—	—	ns	
Data hold time	t _H	250	—	—	ns	
Latch/reset pulse width	t _w	250	—	—	ns	
〈Cross-point input〉						
Input amplifier gain 2	G _{I2}	—1.0	0.0	1.0	dB	I2→IN2O V _{IN} =—20dBV
Input amplifier gain 3	G _{I3}	18.5	19.5	20.5	dB	I3→IN3O V _{IN} =—30dBV
Input amplifier gain 4	G _{I4}	—1.0	0.0	1.0	dB	I4→IN4O V _{IN} =—20dBV
Input amplifier gain 5	G _{I5}	—1.0	0.0	1.0	dB	I5→IN5O V _{IN} =—20dBV
Input amplifier gain 6	G _{I6}	—1.0	0.0	1.0	dB	I6→IN6O V _{IN} =—20dBV
Input amplifier gain 7	G _{I7}	—1.0	0.0	1.0	dB	I7→IN7O V _{IN} =—20dBV
Input amplifier gain 8	G _{I8}	28.0	29.0	30.0	dB	I8→IN8O V _{IN} =—40dBV
Input amplifier gain 9	G _{I9}	—1.0	0.0	1.0	dB	I9→IN9O V _{IN} =—20dBV
Input amplifier distortion	D _I	—	0.1	1.0	%	V _{IN} is the same as that for the input amplifier test
Maximum output level	V _{OMI}	0.0	2.0	—	dBV	At distortion of 10%
Output offset voltage	O _{FI}	—25	0	+25	mV	V _B reference

●Electrical characteristics (unless otherwise noted, Ta = 25°C, Vcc = 5V, f = 1kHz, 400Hz to 30kHz, band pass filter)

Parameter	Symbol	Min.	Typ.	Max.	Unit	Conditions
〈Cross-point switch and output amplifier〉 VIN = -20dBV						
Output amplifier gain 1	GO1	4.5	5.5	6.5	dB	IN5O→O1
Output amplifier gain 2	GO2	-1.5	-0.5	0.5	dB	IN5O→O1, O2~O8
Output amplifier distortion	DO	—	0.1	1.0	%	
Maximum output level 1	VOMO1	5.0	7.0	—	dBV	At distortion of 10%, O1
Maximum output level 2	VOMO2	-0.5	1.5	—	dBV	At distortion of 10%, O2 to O8
Output offset voltage	OFO	-50	0	+50	mV	VB reference
Noise level	NO	—	-83	-70	dBV	
Output level when muted	MX	—	-81	-70	dBV	I5→On
Mixing gain 1	GAI1	4.5	5.5	6.5	dB	A11→O1
Mixing gain 2	GAI2	-1.5	-0.5	0.5	dB	A12→O3, A13→O5
〈8-point electronic volume unit〉 VIN = 20dBV						
Gain	GE1	-1.5	-0.5	0.5	dB	
Attenuation	DGE1	2.0	3.0	4.0	dB	Per step
Distortion	DE1	—	0.1	1.0	%	
Maximum output level	VME1	-0.5	1.5	—	dBV	Distortion 10%
Noise level	NE1	—	-86	-70	dBV	
〈3-point electronic volume unit〉						
Attenuation	DGE2	5.0	6.0	7.0	dB	Per step

●Electrical characteristics (unless otherwise noted, Ta = 25°C, Vcc = 5V, f = 1kHz, 400Hz to 30kHz, band pass filter)

Parameter	Symbol	Min.	Typ.	Max.	Unit	Conditions
〈Switch unit〉 VIN = -20dBV						
Gain	GSW	-1.5	-0.5	0.5	dB	
Distortion	DSW	—	0.1	1.0	%	
Maximum output level	VMSW	0.0	2.0	—	dBV	Distortion 10%
Noise level	NSW	—	-81	-70	dBV	
Output level when muted	MS	—	-81	-70	dBV	
VOX unit						
Detection level	VITH	-44.5	-41.5	-38.5	dBV	VOXOUT=2.5V
VOX high level voltage	VOHVOX	3.8	4.1	—	V	When Io=1 mA
VOX low level voltage	VOLVOX	—	0.8	1.0	V	When Io=-1 mA
ALC unit						
Output level 1	VALC1	-18.0	-17.0	-16.0	dBV	VIN=-50dBV
Output level 2	VALC2	-6.5	-3.5	-0.5	dBV	VIN=-35dBV
Output level 3	VALC3	-4.0	-2.0	0.0	dBV	VIN=0dBV
Distortion	DALC	—	2.0	5.0	%	VIN=0dBV

(2) Timing chart

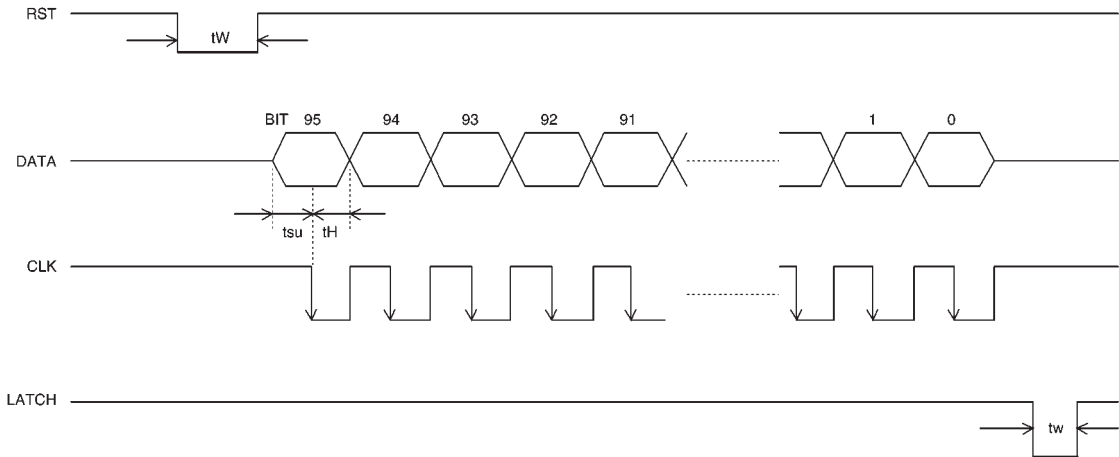

(3) Cross-point switch unit (bits used : 0 to 71)

	IN1	IN2	IN3	IN4	IN5	IN6	IN7	IN8	IN9
OUT1	0	1	2	3	4	5	6	7	8
OUT2	9	10	11	12	13	14	15	16	17
OUT3	18	19	20	21	22	23	24	25	26
OUT4	27	28	29	30	31	32	33	34	35
OUT5	36	37	38	39	40	41	42	43	44
OUT6	45	46	47	48	49	50	51	52	53
OUT7	54	55	56	57	58	59	60	61	62
OUT8	63	64	65	66	67	68	69	70	71

(4) Electronic volume (bits used : 72 to 79)

Bit used	Attenuation (dB)
72	0
73	3
74	6
75	9
76	12
77	15
78	18
79	21

(5) Cross-point unit electronic volume (bits used : 80 to 88)

Attenuation (dB)	IN9	OUT1	OUT2
0	80	83	86
6	81	84	87
12	82	85	88

(6) Modem RX selector switch

Bit	Output pin
93	SW11
94	SW12

(7) OUT7 pin

Bit 95	Output pin
When 0	High impedance
When 1	Normal operation

* Select only one electronic volume.

- (8) 1) Control table (selected with "1"; OFF = 0, ON = 1)
- 2) Bits 89 to 92 are reserved for use as spare bits.
- 3) When resetting, Bit 95 is "1" and all other bits are "0".

●Electrical characteristic curves

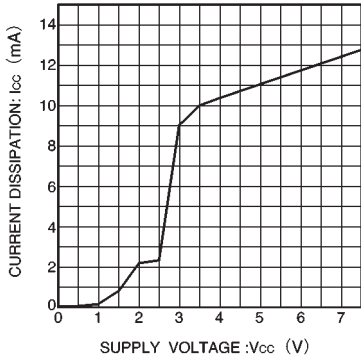

Fig. 2 Current dissipation characteristic

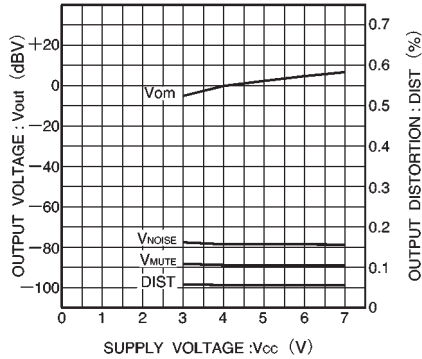

Fig. 3 Cross-point switch voltage characteristic

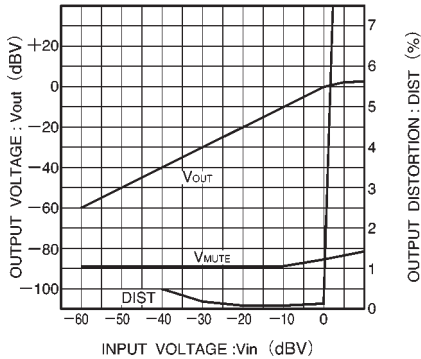

Fig. 4 Cross-point switch I/O characteristic

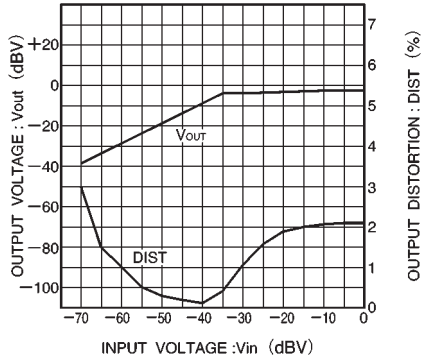

Fig. 5 ALC I/O characteristic

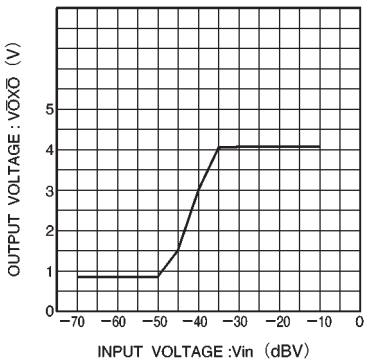

Fig. 6 VOX I/O characteristic

● External dimensions (Units: mm)

