

PIN DESCRIPTION

Pin Number	Symbol	Pin name	Input/Output	Function
1	TESTA	TEST pin	–	Test pin. Open this pin.
2	VSS2	Earthing pin	–	Connect to GND.
3	AC	Auto-clear input	Input	When "L", this pin resets the internal IC circuit. Hysteresis input. Built-in pull-up resistor.
4	CS	Chip select input	Input	Chip select pin. Set this pin to "L" level at serial data transfer. Hysteresis input. Built-in pull-up resistor.
5	SCK	Serial data input	Input	SIN pin serial data is taken in when SCK rises at CS pin "L" level. Hysteresis input. Built-in pull-up resistor.
6	SIN	Serial data input	Input	This is the pin for serial input of display control register and display RAM data. Hysteresis input. Built-in pull-up resistor.
7	TCK	External clock	Input	This is the pin for external clock input.
8	VDD1	Power pin	–	Please connect to +3V with the power pin.
9	P6	Port P6 output	Output	This is the output port.
10	P7	Port P7 output	Output	This is the output port.
11	VSS1	Earthing pin	–	Please connect to GND using circuit earthing pin.
12	P0/BLNK0	Port P0 output	Output	This pin can be toggled between port pin output and BLNK0 signal output.
13	P1/R	Port P1 output	Output	This pin can be toggled between port pin output and R signal output.
14	P2	Port P2 output	Output	This is the output port.
15	P3/G	Port P3 output	Output	This pin can be toggled between port pin output and G signal output.
16	P4	Port P4 output	Output	This is the output port.
17	P5/B	Port P5 output	Output	This pin can be toggled between port pin output and B signal output.
18	HOR	Horizontal synchronous signal input	Input	This pin inputs the horizontal synchronous signal. Hysteresis input.
19	VERT	Vertical synchronous signal input	Input	This pin inputs the vertical synchronous signal. Hysteresis input.
20	VDD2	Power pin	–	Please connect to + 3V with the power pin.

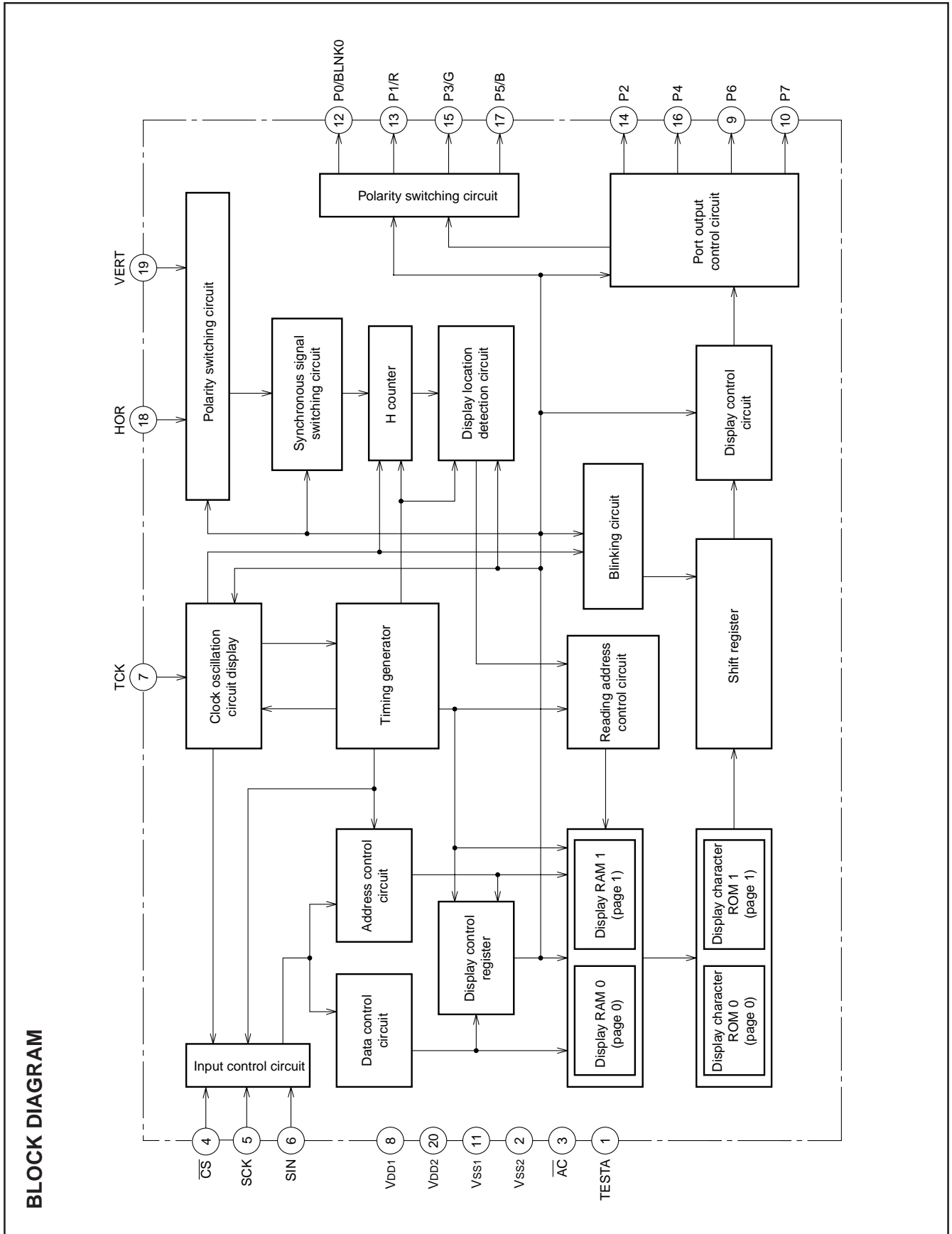

SCREEN CHARACTER and PATTERN DISPLAY CONTROLLERS

MEMORY CONSTITUTION

Address 000₁₆ to 11F₁₆ are assigned to the display RAM, address 120₁₆ to 128₁₆ are assigned to the display control registers. The internal circuit is reset and all display control registers (address 120₁₆ to 128₁₆) are set to "0" when the \overline{AC} pin level is "L". And then, RAM is not erased and be undefined. This memory is con-

sisted of 2 pages : page 0 memory and page 1 memory (their addresses are common), page controlled by DAF bit of each address when writing data. For detail, see "DATA INPUT EXAMPLE". Memory constitution is shown in Figure 1 and 2.

Addresses	DAF	DAE	DAD	DAC	DAB	DAA	DA9	DA8	DA7	DA6	DA5	DA4	DA3	DA2	DA1	DA0
000 ₁₆	0	BB	BG	BR	BLINK	B	G	R	C7	C6	C5	C4	C3	C2	C1	C0
001 ₁₆	0	BB	BG	BR	BLINK	B	G	R	C7	C6	C5	C4	C3	C2	C1	C0
⋮	⋮	Background coloring			Blinking	Character color			Character code							
11E ₁₆	0	BB	BG	BR	BLINK	B	G	R	C7	C6	C5	C4	C3	C2	C1	C0
11F ₁₆	0	BB	BG	BR	BLINK	B	G	R	C7	C6	C5	C4	C3	C2	C1	C0
120 ₁₆	0	TEST27	VJT	TEST26	TEST25	TEST24	TEST23	TEST22	TEST21	TEST20	TEST19	TEST18	TEST17	TEST16	TEST15	TEST14
121 ₁₆	0	TEST28	PTD7	PTD6	PTD5	PTD4	PTD3	PTD2	PTD1	PTD0	PTC5	PTC4	PTC3	PTC2	PTC1	PTC0
122 ₁₆	0	TEST31	SPACE2	SPACE1	SPACE0	TEST30	TEST29	HP8	HP7	HP6	HP5	HP4	HP3	HP2	HP1	HP0
123 ₁₆	0	TEST34	TEST3	TEST2	TEST1	TEST0	TEST33	TEST32	VP7	VP6	VP5	VP4	VP3	VP2	VP1	VP0
124 ₁₆	0	TEST9	TEST5	TEST4	DSP11	DSP10	DSP9	DSP8	DSP7	DSP6	DSP5	DSP4	DSP3	DSP2	DSP1	DSP0
125 ₁₆	0	TEST10	VSZ1H1	VSZ1H0	VSZ1L1	VSZ1L0	V1SZ1	V1SZ0	LIN9	LIN8	LIN7	LIN6	LIN5	LIN4	LIN3	LIN2
126 ₁₆	0	POPUP	VSZ2H1	VSZ2H0	VSZ2L1	VSZ2L0	V18SZ1	V18SZ0	LIN17	LIN16	LIN15	LIN14	LIN13	LIN12	LIN11	LIN10
127 ₁₆	0	MODE0	TEST12	HSZ20	TEST11	HSZ10	BETA14	TEST8	TEST7	TEST6	FB	FG	FR	RB	RG	RR
128 ₁₆	0	MODE1	BLINK2	BLINK1	BLINK0	DSPON	TEST35	RAMERS	SYAD	BLK1	BLK0	POLH	POLV	VMASK	B/F	BCOL

Fig. 1 Memory constitution (page 0 memory)

SCREEN CHARACTER and PATTERN DISPLAY CONTROLLERS

Addresses	DAF	DAE	DAD	DAC	DAB	DAA	DA9	DA8	DA7	DA6	DA5	DA4	DA3	DA2	DA1	DA0
000 ₁₆	1	BB	BG	BR	BLINK	B	G	R	C7	C6	C5	C4	C3	C2	C1	C0
001 ₁₆	1	BB	BG	BR	BLINK	B	G	R	C7	C6	C5	C4	C3	C2	C1	C0
⋮	⋮	Background coloring			Blinking	Character color			Character code							
11E ₁₆	1	BB	BG	BR	BLINK	B	G	R	C7	C6	C5	C4	C3	C2	C1	C0
11F ₁₆	1	BB	BG	BR	BLINK	B	G	R	C7	C6	C5	C4	C3	C2	C1	C0
120 ₁₆	1	—	—	—	—	—	—	—	—	—	—	—	—	—	—	—
121 ₁₆	1	—	—	—	—	—	—	—	—	—	—	—	—	—	—	—
122 ₁₆	1	—	SPACE2	SPACE1	SPACE0	TEST30	TEST29	HP8	HP7	HP6	HP5	HP4	HP3	HP2	HP1	HP0
123 ₁₆	1	—	TEST3	TEST2	TEST1	TEST0	TEST33	TEST32	VP7	VP6	VP5	VP4	VP3	VP2	VP1	VP0
124 ₁₆	1	—	—	TEST4	DSP11	DSP10	DSP9	DSP8	DSP7	DSP6	DSP5	DSP4	DSP3	DSP2	DSP1	DSP0
125 ₁₆	1	—	VSZ1H1	VSZ1H0	VSZ1L1	VSZ1L0	V1SZ1	V1SZ0	LIN9	LIN8	LIN7	LIN6	LIN5	LIN4	LIN3	LIN2
126 ₁₆	1	—	VSZ2H1	VSZ2H0	VSZ2L1	VSZ2L0	V18SZ1	V18SZ0	LIN17	LIN16	LIN15	LIN14	LIN13	LIN12	LIN11	LIN10
127 ₁₆	1	—	TEST12	HSZ20	TEST11	HSZ10	BETA14	TEST8	TEST7	TEST6	FB	FG	FR	RB	RG	RR
128 ₁₆	1	—	BLINK2	BLINK1	BLINK0	DSPON	TEST13	RAMERS	SYAD	BLK1	BLK0	—	—	—	—	BCOL

Fig. 2 Memory constitution (page 1 memory)

Note: Page 0 and page 1 registers are found in their respective pages. For example, HP8 to HP0 of the page 0 memory sets the horizontal display start position of page 0, whereas HP8 to HP0 (same register name) of the page 1 memory sets the horizontal display start position of page 1. Also, registers common to both page 0 and page 1 are found only in the page 0 memory. For example, PTC0 is the control register of the P0 pin and is found only in the page 0 memory.

SCREEN CHARACTER and PATTERN DISPLAY CONTROLLERS

SCREEN CONSTITUTION

The screen lines and rows are determined from each address of the display RAM (page 0 and page 1 are common). The screen constitution is shown in Figure 3.

Row Line	1	2	3	4	5	6	7	8	9	10	11	12	13	14	15	16	17	18	19	20	21	22	23	24
1	000 ₁₆	001 ₁₆	002 ₁₆	003 ₁₆	004 ₁₆	005 ₁₆	006 ₁₆	007 ₁₆	008 ₁₆	009 ₁₆	00A ₁₆	00B ₁₆	00C ₁₆	00D ₁₆	00E ₁₆	00F ₁₆	010 ₁₆	011 ₁₆	012 ₁₆	013 ₁₆	014 ₁₆	015 ₁₆	016 ₁₆	017 ₁₆
2	018 ₁₆	019 ₁₆	01A ₁₆	01B ₁₆	01C ₁₆	01D ₁₆	01E ₁₆	01F ₁₆	020 ₁₆	021 ₁₆	022 ₁₆	023 ₁₆	024 ₁₆	025 ₁₆	026 ₁₆	027 ₁₆	028 ₁₆	029 ₁₆	02A ₁₆	02B ₁₆	02C ₁₆	02D ₁₆	02E ₁₆	02F ₁₆
3	030 ₁₆	031 ₁₆	032 ₁₆	033 ₁₆	034 ₁₆	035 ₁₆	036 ₁₆	037 ₁₆	038 ₁₆	039 ₁₆	03A ₁₆	03B ₁₆	03C ₁₆	03D ₁₆	03E ₁₆	03F ₁₆	040 ₁₆	041 ₁₆	042 ₁₆	043 ₁₆	044 ₁₆	045 ₁₆	046 ₁₆	047 ₁₆
4	048 ₁₆	049 ₁₆	04A ₁₆	04B ₁₆	04C ₁₆	04D ₁₆	04E ₁₆	04F ₁₆	050 ₁₆	051 ₁₆	052 ₁₆	053 ₁₆	054 ₁₆	055 ₁₆	056 ₁₆	057 ₁₆	058 ₁₆	059 ₁₆	05A ₁₆	05B ₁₆	05C ₁₆	05D ₁₆	05E ₁₆	05F ₁₆
5	060 ₁₆	061 ₁₆	062 ₁₆	063 ₁₆	064 ₁₆	065 ₁₆	066 ₁₆	067 ₁₆	068 ₁₆	069 ₁₆	06A ₁₆	06B ₁₆	06C ₁₆	06D ₁₆	06E ₁₆	06F ₁₆	070 ₁₆	071 ₁₆	072 ₁₆	073 ₁₆	074 ₁₆	075 ₁₆	076 ₁₆	077 ₁₆
6	078 ₁₆	079 ₁₆	07A ₁₆	07B ₁₆	07C ₁₆	07D ₁₆	07E ₁₆	07F ₁₆	080 ₁₆	081 ₁₆	082 ₁₆	083 ₁₆	084 ₁₆	085 ₁₆	086 ₁₆	087 ₁₆	088 ₁₆	089 ₁₆	08A ₁₆	08B ₁₆	08C ₁₆	08D ₁₆	08E ₁₆	08F ₁₆
7	090 ₁₆	091 ₁₆	092 ₁₆	093 ₁₆	094 ₁₆	095 ₁₆	096 ₁₆	097 ₁₆	098 ₁₆	099 ₁₆	09A ₁₆	09B ₁₆	09C ₁₆	09D ₁₆	09E ₁₆	09F ₁₆	0A0 ₁₆	0A1 ₁₆	0A2 ₁₆	0A3 ₁₆	0A4 ₁₆	0A5 ₁₆	0A6 ₁₆	0A7 ₁₆
8	0A8 ₁₆	0A9 ₁₆	0AA ₁₆	0AB ₁₆	0AC ₁₆	0AD ₁₆	0AE ₁₆	0AF ₁₆	0B0 ₁₆	0B1 ₁₆	0B2 ₁₆	0B3 ₁₆	0B4 ₁₆	0B5 ₁₆	0B6 ₁₆	0B7 ₁₆	0B8 ₁₆	0B9 ₁₆	0BA ₁₆	0BB ₁₆	0BC ₁₆	0BD ₁₆	0BE ₁₆	0BF ₁₆
9	0C0 ₁₆	0C1 ₁₆	0C2 ₁₆	0C3 ₁₆	0C4 ₁₆	0C5 ₁₆	0C6 ₁₆	0C7 ₁₆	0C8 ₁₆	0C9 ₁₆	0CA ₁₆	0CB ₁₆	0CC ₁₆	0CD ₁₆	0CE ₁₆	0CF ₁₆	0D0 ₁₆	0D1 ₁₆	0D2 ₁₆	0D3 ₁₆	0D4 ₁₆	0D5 ₁₆	0D6 ₁₆	0D7 ₁₆
10	0D8 ₁₆	0D9 ₁₆	0DA ₁₆	0DB ₁₆	0DC ₁₆	0DD ₁₆	0DE ₁₆	0DF ₁₆	0E0 ₁₆	0E1 ₁₆	0E2 ₁₆	0E3 ₁₆	0E4 ₁₆	0E5 ₁₆	0E6 ₁₆	0E7 ₁₆	0E8 ₁₆	0E9 ₁₆	0EA ₁₆	0EB ₁₆	0EC ₁₆	0ED ₁₆	0EE ₁₆	0EF ₁₆
11	0F0 ₁₆	0F1 ₁₆	0F2 ₁₆	0F3 ₁₆	0F4 ₁₆	0F5 ₁₆	0F6 ₁₆	0F7 ₁₆	0F8 ₁₆	0F9 ₁₆	0FA ₁₆	0FB ₁₆	0FC ₁₆	0FD ₁₆	0FE ₁₆	0FF ₁₆	100 ₁₆	101 ₁₆	102 ₁₆	103 ₁₆	104 ₁₆	105 ₁₆	106 ₁₆	107 ₁₆
12	108 ₁₆	109 ₁₆	10A ₁₆	10B ₁₆	10C ₁₆	10D ₁₆	10E ₁₆	10F ₁₆	110 ₁₆	111 ₁₆	112 ₁₆	113 ₁₆	114 ₁₆	115 ₁₆	116 ₁₆	117 ₁₆	118 ₁₆	119 ₁₆	11A ₁₆	11B ₁₆	11C ₁₆	11D ₁₆	11E ₁₆	11F ₁₆

* The hexadecimal numbers in the boxes show the display RAM address.

Fig. 3 Screen constitution

SCREEN CHARACTER and PATTERN DISPLAY CONTROLLERS

DISPLAY RAM

Address 000₁₆ to 11F₁₆

DA	Register	Contents		Remarks																																					
		Status	Function																																						
0	C0	0	Set the displayed ROM character code.	Set display character																																					
		1																																							
1	C1	0	To write data into page 0 (Note 2), select the data from the ROM characters (256 types) for page 0 and set the character code. To write data into page 1, do the same from the ROM characters (256 types) for page 1.																																						
		1																																							
2	C2	0																																							
		1																																							
3	C3	0																																							
		1																																							
4	C4	0																																							
		1																																							
5	C5	0																																							
		1																																							
6	C6	0																																							
		1																																							
7	C7	0																																							
		1																																							
8	R	0		<table border="1"> <thead> <tr> <th>B</th> <th>G</th> <th>R</th> <th>Color</th> </tr> </thead> <tbody> <tr><td>0</td><td>0</td><td>0</td><td>Black</td></tr> <tr><td>0</td><td>0</td><td>1</td><td>Red</td></tr> <tr><td>0</td><td>1</td><td>0</td><td>Green</td></tr> <tr><td>0</td><td>1</td><td>1</td><td>Yellow</td></tr> <tr><td>1</td><td>0</td><td>0</td><td>Blue</td></tr> <tr><td>1</td><td>0</td><td>1</td><td>Magenta</td></tr> <tr><td>1</td><td>1</td><td>0</td><td>Cyan</td></tr> <tr><td>1</td><td>1</td><td>1</td><td>White</td></tr> </tbody> </table>	B	G	R	Color	0	0	0	Black	0	0	1	Red	0	1	0	Green	0	1	1	Yellow	1	0	0	Blue	1	0	1	Magenta	1	1	0	Cyan	1	1	1	White	Set character color (character unit)
		B			G	R	Color																																		
0	0	0	Black																																						
0	0	1	Red																																						
0	1	0	Green																																						
0	1	1	Yellow																																						
1	0	0	Blue																																						
1	0	1	Magenta																																						
1	1	0	Cyan																																						
1	1	1	White																																						
1																																									
9	G	0																																							
		1																																							
A	B	0																																							
		1																																							
B	BLINK	0	Do not blink.		Set blinking See register BLINK2 to BLINK0 (address 128 ₁₆)																																				
		1	Blinking																																						
C	BR	0	<table border="1"> <thead> <tr> <th>BB</th> <th>BG</th> <th>BR</th> <th>Color</th> </tr> </thead> <tbody> <tr><td>0</td><td>0</td><td>0</td><td>Black</td></tr> <tr><td>0</td><td>0</td><td>1</td><td>Red</td></tr> <tr><td>0</td><td>1</td><td>0</td><td>Green</td></tr> <tr><td>0</td><td>1</td><td>1</td><td>Yellow</td></tr> <tr><td>1</td><td>0</td><td>0</td><td>Blue</td></tr> <tr><td>1</td><td>0</td><td>1</td><td>Magenta</td></tr> <tr><td>1</td><td>1</td><td>0</td><td>Cyan</td></tr> <tr><td>1</td><td>1</td><td>1</td><td>White</td></tr> </tbody> </table>	BB	BG	BR	Color	0	0	0	Black	0	0	1	Red	0	1	0	Green	0	1	1	Yellow	1	0	0	Blue	1	0	1	Magenta	1	1	0	Cyan	1	1	1	White	Set character background (character unit)	
		BB		BG	BR	Color																																			
0	0	0		Black																																					
0	0	1		Red																																					
0	1	0		Green																																					
0	1	1		Yellow																																					
1	0	0		Blue																																					
1	0	1		Magenta																																					
1	1	0		Cyan																																					
1	1	1		White																																					
1																																									
D	BG	0																																							
		1																																							
E	BB	0																																							
		1																																							

Notes 1. The display RAM is undefined state at the AC pin.

2. The display RAM consists of 2 pages, page 0 and page 1 (common address). The page in which data is written is controlled by the DAF bit. When set to "0", data is written into page 0, whereas when set to "1", data is written into page 1.

REGISTERS DESCRIPTION

(1) Address 120₁₆

DA	Register	Contents		Remarks
		Status	Function	
0	TEST14 (Note 3)	0	It should be fixed to "0".	
		1	Can not be used.	
1	TEST15 (Note 3)	0	It should be fixed to "0".	
		1	Can not be used.	
2	TEST16 (Note 3)	0	It should be fixed to "0".	
		1	Can not be used.	
3	TEST17 (Note 3)	0	It should be fixed to "0".	
		1	Can not be used.	
4	TEST18 (Note 3)	0	It should be fixed to "0".	
		1	Can not be used.	
5	TEST19 (Note 3)	0	It should be fixed to "0".	
		1	Can not be used.	
6	TEST20 (Note 3)	0	It should be fixed to "0".	
		1	Can not be used.	
7	TEST21 (Note 3)	0	It should be fixed to "0".	
		1	Can not be used.It should be fixed to "0".	
8	TEST22 (Note 3)	0	Can not be used.	
		1	It should be fixed to "0".	
9	TEST23 (Note 3)	0	Can not be used.	
		1	It should be fixed to "0".	
A	TEST24 (Note 3)	0	Can not be used.	
		1	It should be fixed to "0".	
B	TEST25 (Note 3)	0	Can not be used.	
		1	It should be fixed to "0".	
C	TEST26 (Note 3)	0	Can not be used.	
		1	It should be fixed to "0".	
D	VJT	0	It is used to "0", normally.	
		1	Alleviates continuous vertical jitters.	
E	TEST27 (Note 3)	0	Can not be used.	
		1	It should be fixed to "0".	

Notes 1. The mark 0 around the status value means the reset status by the "L" level is input to AC pin.

2. The page in which data is written is controlled by the DAF bit. When set to "0", data is written into page 0, whereas when set to "1", data is written into page 1.

3. Registers marked with (Note 3) are found only in page 0, therefore the register value does not change when the DAF bit is set to "1".

SCREEN CHARACTER and PATTERN DISPLAY CONTROLLERS

(2) Address 12116

DA	Register	Contents		Remarks
		Status	Function	
0	PTC0 (Note 3)	①	P0 output (port P0).	P0 pin output control.
		1	BLNK0 output.	
1	PTC1 (Note 3)	①	P1 output (port P1).	P1 pin output control.
		1	R signal output.	
2	PTC2 (Note 3)	①	P2 output (port P2).	P2 pin output control.
		1	Can not be used.	
3	PTC3 (Note 3)	①	P3 output (port P3).	P3 pin output control.
		1	G signal output.	
4	PTC4 (Note 3)	①	P4 output (port P4).	P4 pin output control.
		1	Can not be used.	
5	PTC5 (Note 3)	①	P5 output (port P5).	P5 pin output control.
		1	B signal output.	
6	PTD0 (Note 3)	①	"L" output or negative polarity output (BLNK0 output).	P0 pin data control.
		1	"H" output or positive polarity output (BLNK0 output).	
7	PTD1 (Note 3)	①	"L" output or negative polarity output (R signal output).	P1 pin data control.
		1	"H" output or positive polarity output (R signal output).	
8	PTD2 (Note 3)	①	"L" output.	P2 pin data control.
		1	"H" output.	
9	PTD3 (Note 3)	①	"L" output or negative polarity output (G signal output).	P3 pin data control.
		1	"H" output or positive polarity output (G signal output).	
A	PTD4 (Note 3)	①	"L" output.	P4 pin data control.
		1	"H" output.	
B	PTD5 (Note 3)	①	"L" output or negative polarity output (B signal output).	P5 pin data control.
		1	"H" output or positive polarity output (B signal output).	
C	PTD6 (Note 3)	①	"L" output.	P6 pin data control.
		1	"H" output.	
D	PTD7 (Note 3)	①	"L" output.	P7 pin data control.
		1	"H" output.	
E	TEST28 (Note 3)	①	Can not be used.	
		1	It should be fixed to "0".	

Notes 1. The mark ① around the status value means the reset status by the "L" level is input to AC pin.

2. The page in which data is written is controlled by the DAF bit. When set to "0", data is written into page 0, whereas when set to "1", data is written into page 1.

3. Registers marked with (Note 3) are found only in page 0, therefore the register value does not change when the DAF bit is set to "1".

SCREEN CHARACTER and PATTERN DISPLAY CONTROLLERS

(3) Address 12216

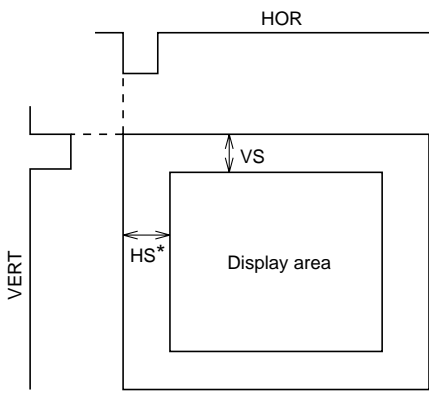
DA	Register	Contents		Remarks																																								
		Status	Function																																									
0	HP0	0	If HS is the horizontal display start location,	Horizontal display start location is specified using the 11 bits from HP8 to HP0. HP8 to HP0 = (000000000002) and (000001001112) setting is forbidden.																																								
		1	$HS = T \times (\sum_{n=0}^8 2^n HP_n + 6)$																																									
1	HP1	0	T : Period of display frequency																																									
		1	472 settings are possible.																																									
2	HP2	0																																										
		1																																										
3	HP3	0																																										
		1																																										
4	HP4	0																																										
		1																																										
5	HP5	0																																										
		1																																										
6	HP6	0																																										
		1																																										
7	HP7	0																																										
		1																																										
8	HP8	0																																										
		1																																										
9	TEST29	0	Can not be used.	 <p>HS* (shown left) shows horizontal display start location that is register B/F (address 12816) = 0 is set.</p>																																								
		1	It should be fixed to "0".																																									
A	TEST30	0	Can not be used.																																									
		1	It should be fixed to "0".																																									
B	SPACE0	0	<table border="1"> <thead> <tr> <th colspan="3">SPACE</th> <th rowspan="2">Number of Lines and Space <(S) represents space></th> </tr> <tr> <th>2</th> <th>1</th> <th>0</th> </tr> </thead> <tbody> <tr> <td>0</td> <td>0</td> <td>0</td> <td>12</td> </tr> <tr> <td>0</td> <td>0</td> <td>1</td> <td>1 (S) 10 (S) 1</td> </tr> <tr> <td>0</td> <td>1</td> <td>0</td> <td>2 (S) 8 (S) 2</td> </tr> <tr> <td>0</td> <td>1</td> <td>1</td> <td>3 (S) 6 (S) 3</td> </tr> <tr> <td>1</td> <td>0</td> <td>0</td> <td>4 (S) 4 (S) 4</td> </tr> <tr> <td>1</td> <td>0</td> <td>1</td> <td>5 (S) 2 (S) 5</td> </tr> <tr> <td>1</td> <td>1</td> <td>0</td> <td>6 (S) 6</td> </tr> <tr> <td>1</td> <td>1</td> <td>1</td> <td>6 (S)(S) 6</td> </tr> </tbody> </table>		SPACE			Number of Lines and Space <(S) represents space>	2	1	0	0	0	0	12	0	0	1	1 (S) 10 (S) 1	0	1	0	2 (S) 8 (S) 2	0	1	1	3 (S) 6 (S) 3	1	0	0	4 (S) 4 (S) 4	1	0	1	5 (S) 2 (S) 5	1	1	0	6 (S) 6	1	1	1	6 (S)(S) 6	Leave one line worth of space in the vertical direction. For example, 6 (S) 6 indicates two sets of 6 lines with a line of spaces between lines 6 and 7. A line is 18 × N horizontal scan lines. N is determined by the character size in the vertical direction
		SPACE			Number of Lines and Space <(S) represents space>																																							
2	1	0																																										
0	0	0	12																																									
0	0	1	1 (S) 10 (S) 1																																									
0	1	0	2 (S) 8 (S) 2																																									
0	1	1	3 (S) 6 (S) 3																																									
1	0	0	4 (S) 4 (S) 4																																									
1	0	1	5 (S) 2 (S) 5																																									
1	1	0	6 (S) 6																																									
1	1	1	6 (S)(S) 6																																									
1	(S) represents one line worth of space																																											
E	TEST31 (Note 3)	0	Can not be used.																																									
		1	It should be fixed to "0".																																									

Notes 1. The mark ○ around the status value means the reset status by the "L" level is input to AC pin.
 2. The page in which data is written is controlled by the DAF bit. When set to "0", data is written into page 0, whereas when set to "1", data is written into page 1.
 3. Registers marked with (Note 3) are found only in page 0, therefore the register value does not change when the DAF bit is set to "1".

SCREEN CHARACTER and PATTERN DISPLAY CONTROLLERS

(4) Address 12316

DA	Register	Contents		Remarks
		Status	Function	
0	VP0	0	If VS is the vertical display start location,	The vertical start location is specified using the 10 bits from VP7 to VP0. VP7 to VP0 = (0000000002) setting is forbidden.
		1	$VS = H \times \sum_{n=0}^7 2^n VP_n$	
1	VP1	0	H: Cycle with the horizontal synchronizing pulse	
		1	255 settings are possible.	
2	VP2	0	<p>The diagram shows two waveforms: VERT (vertical sync) and HOR (horizontal sync). The VERT signal has a pulse that defines the vertical start location VS. The HOR signal has a pulse that defines the horizontal start location HS*. A central rectangular area is labeled 'Display area'. The vertical extent of the display area is marked as VS, and the horizontal extent is marked as HS*.</p>	
		1		
3	VP3	0		
		1		
4	VP4	0		
		1		
5	VP5	0		
		1		
6	VP6	0		
		1		
7	VP7	0		
		1		
8	TEST32	0		It should be fixed to "0".
		1		Can not be used.
9	TEST33	0		It should be fixed to "0".
		1		Can not be used.
A	TEST0	0	It should be fixed to "0".	
		1	Can not be used.	
B	TEST1	0	It should be fixed to "0".	
		1	Can not be used.	
C	TEST2	0	It should be fixed to "0".	
		1	Can not be used.	
D	TEST3	0	It should be fixed to "0".	
		1	Can not be used.	
E	TEST34 (Note 3)	0	It should be fixed to "0".	
		1	Can not be used.	

Notes 1. The mark ○ around the status value means the reset status by the "L" level is input to AC pin.

2. The page in which data is written is controlled by the DAF bit. When set to "0", data is written into page 0, whereas when set to "1", data is written into page 1.

3. Registers marked with (Note 3) are found only in page 0, therefore the register value does not change when the DAF bit is set to "1".

SCREEN CHARACTER and PATTERN DISPLAY CONTROLLERS

(5) Address 12416

DA	Register	Contents		Remarks																				
		Status	Function																					
0	DSP0	0	The display mode (blanking mode) for line n on the display screen is set line-by-line, using DSPn (n = 0 to 11).	Sets the display mode of line 1.																				
		1																						
1	DSP1	0	The display mode is determined by the combination of registers BLK1 and BLK0 (address 12816). Settings are given below.	Sets the display mode of line 2.																				
		1																						
2	DSP2	0	<table border="1" style="margin-left: auto; margin-right: auto;"> <thead> <tr> <th>BLK1</th> <th>BLK0</th> <th>DSPn= "0"</th> <th>DSPn= "1"</th> </tr> </thead> <tbody> <tr> <td>0</td> <td>0</td> <td>Matrix-outline border</td> <td>Matrix-outline</td> </tr> <tr> <td>0</td> <td>1</td> <td>Character</td> <td>Border</td> </tr> <tr> <td>1</td> <td>0</td> <td>Border</td> <td>Matrix-outline</td> </tr> <tr> <td>1</td> <td>1</td> <td>Matrix-outline</td> <td>Character</td> </tr> </tbody> </table>	BLK1	BLK0	DSPn= "0"	DSPn= "1"	0	0	Matrix-outline border	Matrix-outline	0	1	Character	Border	1	0	Border	Matrix-outline	1	1	Matrix-outline	Character	Sets the display mode of line 3.
		BLK1		BLK0	DSPn= "0"	DSPn= "1"																		
0	0	Matrix-outline border	Matrix-outline																					
0	1	Character	Border																					
1	0	Border	Matrix-outline																					
1	1	Matrix-outline	Character																					
1																								
3	DSP3	0	(At register BCOL = "0")	Sets the display mode of line 4.																				
		1																						
4	DSP4	0	For detail, see DISPLAY FORM1(1).	Sets the display mode of line 5.																				
		1																						
5	DSP5	0		Sets the display mode of line 6.																				
		1																						
6	DSP6	0		Sets the display mode of line 7.																				
		1																						
7	DSP7	0		Sets the display mode of line 8.																				
		1																						
8	DSP8	0		Sets the display mode of line 9.																				
		1																						
9	DSP9	0		Sets the display mode of line 10.																				
		1																						
A	DSP10	0		Sets the display mode of line 11.																				
		1																						
B	DSP11	0		Sets the display mode of line 12.																				
		1																						
C	TEST4	0	It should be fixed to "0".																					
		1	Can not be used.																					
D	TEST5 (Note 3)	0	It should be fixed to "0".																					
		1	Can not be used.																					
E	TEST9 (Note 3)	0	Can not be used.																					
		1	It should be fixed to "1".																					

- Notes 1. The mark ○ around the status value means the reset status by the "L" level is input to AC pin.
 2. The page in which data is written is controlled by the DAF bit. When set to "0", data is written into page 0, whereas when set to "1", data is written into page 1.
 3. Registers marked with (Note 3) are found only in page 0, therefore the register value does not change when the DAF bit is set to "1".

SCREEN CHARACTER and PATTERN DISPLAY CONTROLLERS

(6) Address 12516

DA	Register	Contents		Remarks															
		Status	Function																
0	LIN2	0	The vertical dot size for line n in the character dot lines (18 vertical lines) is set using LINn (n = 2 to 17).	Vertical direction dot size setting for the 2nd line.															
		1																	
1	LIN3	0	Dot size can be selected between 2 types for each dot line.	Vertical direction dot size setting for the 3rd line.															
		1																	
2	LIN4	0	For dot size, see the below registers. Line 1 and lines 2 to 12 can be set independent of one another.	Vertical direction dot size setting for the 4th line.															
		1																	
3	LIN5	0	<table border="1" style="margin-left: auto; margin-right: auto;"> <thead> <tr> <th></th> <th>LINn = "0"</th> <th>LINn = "1"</th> </tr> </thead> <tbody> <tr> <td>1st line</td> <td>Refer to VSZ1L0 and VSZ1L1</td> <td>Refer to VSZ1H0 and VSZ1H1</td> </tr> <tr> <td>2nd to 12th line</td> <td>Refer to VSZ2L0 and VSZ2L1</td> <td>Refer to VSZ2H0 and VSZ2H1</td> </tr> </tbody> </table>		LINn = "0"	LINn = "1"	1st line	Refer to VSZ1L0 and VSZ1L1	Refer to VSZ1H0 and VSZ1H1	2nd to 12th line	Refer to VSZ2L0 and VSZ2L1	Refer to VSZ2H0 and VSZ2H1	Vertical direction dot size setting for the 5th line.						
				LINn = "0"	LINn = "1"														
1st line	Refer to VSZ1L0 and VSZ1L1	Refer to VSZ1H0 and VSZ1H1																	
2nd to 12th line	Refer to VSZ2L0 and VSZ2L1	Refer to VSZ2H0 and VSZ2H1																	
1																			
4	LIN6	0		Vertical direction dot size setting for the 6th line.															
		1																	
5	LIN7	0		Vertical direction dot size setting for the 7th line.															
		1																	
6	LIN8	0		Vertical direction dot size setting for the 8th line.															
		1																	
7	LIN9	0		Vertical direction dot size setting for the 9th line.															
		1																	
8	V1SZ0	0	H: Cycle with the horizontal synchronizing pulse	Vertical direction dot size setting for the 1st line. (all lines are common)															
		1																	
9	V1SZ1	0	<table border="1" style="margin-left: auto; margin-right: auto;"> <thead> <tr> <th>V1SZ1</th> <th>V1SZ0</th> <th>Vertical direction size</th> </tr> </thead> <tbody> <tr> <td>0</td> <td>0</td> <td>1H/dot</td> </tr> <tr> <td>0</td> <td>1</td> <td>2H/dot</td> </tr> <tr> <td>1</td> <td>0</td> <td>3H/dot</td> </tr> <tr> <td>1</td> <td>1</td> <td>4H/dot</td> </tr> </tbody> </table>	V1SZ1	V1SZ0	Vertical direction size	0	0	1H/dot	0	1	2H/dot	1	0	3H/dot	1	1	4H/dot	
		V1SZ1		V1SZ0	Vertical direction size														
0	0	1H/dot																	
0	1	2H/dot																	
1	0	3H/dot																	
1	1	4H/dot																	
1																			
A	VSZ1L0	0	H: Cycle with the horizontal synchronizing pulse	Character dot line vertical direction dot size setting for the 1st line (LINn = 0).															
		1																	
B	VSZ1L1	0	<table border="1" style="margin-left: auto; margin-right: auto;"> <thead> <tr> <th>VSZ1L1</th> <th>VSZ1L0</th> <th>Vertical direction size</th> </tr> </thead> <tbody> <tr> <td>0</td> <td>0</td> <td>1H/dot</td> </tr> <tr> <td>0</td> <td>1</td> <td>2H/dot</td> </tr> <tr> <td>1</td> <td>0</td> <td>3H/dot</td> </tr> <tr> <td>1</td> <td>1</td> <td>4H/dot</td> </tr> </tbody> </table>	VSZ1L1	VSZ1L0	Vertical direction size	0	0	1H/dot	0	1	2H/dot	1	0	3H/dot	1	1	4H/dot	
		VSZ1L1		VSZ1L0	Vertical direction size														
0	0	1H/dot																	
0	1	2H/dot																	
1	0	3H/dot																	
1	1	4H/dot																	
1																			
C	VSZ1H0	0	H: Cycle with the horizontal synchronizing pulse	Character dot line vertical direction dot size setting for the 1st line (LINn = 1).															
		1																	
D	VSZ1H1	0	<table border="1" style="margin-left: auto; margin-right: auto;"> <thead> <tr> <th>VSZ1H1</th> <th>VSZ1H0</th> <th>Vertical direction size</th> </tr> </thead> <tbody> <tr> <td>0</td> <td>0</td> <td>1H/dot</td> </tr> <tr> <td>0</td> <td>1</td> <td>2H/dot</td> </tr> <tr> <td>1</td> <td>0</td> <td>3H/dot</td> </tr> <tr> <td>1</td> <td>1</td> <td>4H/dot</td> </tr> </tbody> </table>	VSZ1H1	VSZ1H0	Vertical direction size	0	0	1H/dot	0	1	2H/dot	1	0	3H/dot	1	1	4H/dot	
		VSZ1H1		VSZ1H0	Vertical direction size														
0	0	1H/dot																	
0	1	2H/dot																	
1	0	3H/dot																	
1	1	4H/dot																	
1																			
E	TEST10 (Note 3)	0	It should be fixed to "0".																
		1			Can not be used.														

- Notes 1. The mark ○ around the status value means the reset status by the "L" level is input to AC pin.
 2. The page in which data is written is controlled by the DAF bit. When set to "0", data is written into page 0, whereas when set to "1", data is written into page 1.
 3. Registers marked with (Note 3) are found only in page 0, therefore the register value does not change when the DAF bit is set to "1".

SCREEN CHARACTER and PATTERN DISPLAY CONTROLLERS

(7) Address 12616

DA	Register	Contents		Remarks															
		Status	Function																
0	LIN10	0	The vertical dot size for line n in the character dot lines (18 vertical lines) is set using LINn (n = 2 to 17).	Vertical direction dot size setting for the 11th line.															
		1																	
1	LIN11	0	Dot size can be selected between 2 types for each dot line.	Vertical direction dot size setting for the 11th line.															
		1																	
2	LIN12	0	For dot size, see the below registers. Line 1 and lines 2 to 12 can be set independent of one another.	Vertical direction dot size setting for the 12th line.															
		1																	
3	LIN13	0	<table border="1" style="margin-left: auto; margin-right: auto;"> <thead> <tr> <th></th> <th>LINn = "0"</th> <th>LINn = "1"</th> </tr> </thead> <tbody> <tr> <td>1st line</td> <td>Refer to VSZ1L0 and VSZ1L1</td> <td>Refer to VSZ1H0 and VSZ1H1</td> </tr> <tr> <td>2nd to 12th line</td> <td>Refer to VSZ2L0 and VSZ2L1</td> <td>Refer to VSZ2H0 and VSZ2H1</td> </tr> </tbody> </table>		LINn = "0"	LINn = "1"	1st line	Refer to VSZ1L0 and VSZ1L1	Refer to VSZ1H0 and VSZ1H1	2nd to 12th line	Refer to VSZ2L0 and VSZ2L1	Refer to VSZ2H0 and VSZ2H1	Vertical direction dot size setting for the 13th line.						
				LINn = "0"	LINn = "1"														
1st line	Refer to VSZ1L0 and VSZ1L1	Refer to VSZ1H0 and VSZ1H1																	
2nd to 12th line	Refer to VSZ2L0 and VSZ2L1	Refer to VSZ2H0 and VSZ2H1																	
1																			
4	LIN14	0		Vertical direction dot size setting for the 14th line.															
		1																	
5	LIN15	0		Vertical direction dot size setting for the 15th line.															
		1																	
6	LIN16	0		Vertical direction dot size setting for the 16th line.															
		1																	
7	LIN17	0		Vertical direction dot size setting for the 17th line.															
		1																	
8	V18SZ0	0	H: Cycle with the horizontal synchronizing pulse	Vertical direction dot size setting for the 18th line. (all lines are common)															
		1																	
9	V18SZ1	0	<table border="1" style="margin-left: auto; margin-right: auto;"> <thead> <tr> <th>V18SZ1</th> <th>V18SZ0</th> <th>Vertical direction size</th> </tr> </thead> <tbody> <tr> <td>0</td> <td>0</td> <td>1H/dot</td> </tr> <tr> <td>0</td> <td>1</td> <td>2H/dot</td> </tr> <tr> <td>1</td> <td>0</td> <td>3H/dot</td> </tr> <tr> <td>1</td> <td>1</td> <td>4H/dot</td> </tr> </tbody> </table>	V18SZ1	V18SZ0	Vertical direction size	0	0	1H/dot	0	1	2H/dot	1	0	3H/dot	1	1	4H/dot	
		V18SZ1		V18SZ0	Vertical direction size														
0	0	1H/dot																	
0	1	2H/dot																	
1	0	3H/dot																	
1	1	4H/dot																	
1																			
A	VSZ2L0	0	H: Cycle with the horizontal synchronizing pulse	Character dot line vertical direction dot size setting for the 2nd line to 12th line (LINn = 0).															
		1																	
B	VSZ2L1	0	<table border="1" style="margin-left: auto; margin-right: auto;"> <thead> <tr> <th>VSZ2L1</th> <th>VSZ2L0</th> <th>Vertical direction size</th> </tr> </thead> <tbody> <tr> <td>0</td> <td>0</td> <td>1H/dot</td> </tr> <tr> <td>0</td> <td>1</td> <td>2H/dot</td> </tr> <tr> <td>1</td> <td>0</td> <td>3H/dot</td> </tr> <tr> <td>1</td> <td>1</td> <td>4H/dot</td> </tr> </tbody> </table>	VSZ2L1	VSZ2L0	Vertical direction size	0	0	1H/dot	0	1	2H/dot	1	0	3H/dot	1	1	4H/dot	
		VSZ2L1		VSZ2L0	Vertical direction size														
0	0	1H/dot																	
0	1	2H/dot																	
1	0	3H/dot																	
1	1	4H/dot																	
1																			
C	VSZ2H0	0	H: Cycle with the horizontal synchronizing pulse	Character dot line vertical direction dot size setting for the 2nd line to 12th line (LINn = 1).															
		1																	
D	VSZ2H1	0	<table border="1" style="margin-left: auto; margin-right: auto;"> <thead> <tr> <th>VSZ2H1</th> <th>VSZ2H0</th> <th>Vertical direction size</th> </tr> </thead> <tbody> <tr> <td>0</td> <td>0</td> <td>1H/dot</td> </tr> <tr> <td>0</td> <td>1</td> <td>2H/dot</td> </tr> <tr> <td>1</td> <td>0</td> <td>3H/dot</td> </tr> <tr> <td>1</td> <td>1</td> <td>4H/dot</td> </tr> </tbody> </table>	VSZ2H1	VSZ2H0	Vertical direction size	0	0	1H/dot	0	1	2H/dot	1	0	3H/dot	1	1	4H/dot	
		VSZ2H1		VSZ2H0	Vertical direction size														
0	0	1H/dot																	
0	1	2H/dot																	
1	0	3H/dot																	
1	1	4H/dot																	
1																			
E	POPUP (Note 3)	0	Page 1 priority display	Sets the priority page for when 2 pages are displayed at the same time. The setting is effective only when the standard display mode is set as MODE0 = "0", MODE1 = "0". See "DISPLAY FORM 2".															
		1	Page 0 priority display																

Notes 1. The mark 0 around the status value means the reset status by the "L" level is input to AC pin.

2. The page in which data is written is controlled by the DAF bit. When set to "0", data is written into page 0, whereas when set to "1", data is written into page 1.

3. Registers marked with (Note 3) are found only in page 0, therefore the register value does not change when the DAF bit is set to "1".

SCREEN CHARACTER and PATTERN DISPLAY CONTROLLERS

(8) Address 12716

DA	Register	Contents				Remarks																								
		Status	Function																											
0	RR	0	<table border="1"> <thead> <tr> <th>RB</th> <th>RG</th> <th>RR</th> <th>Color</th> </tr> </thead> <tbody> <tr> <td>0</td> <td>0</td> <td>0</td> <td>Black</td> </tr> <tr> <td>0</td> <td>0</td> <td>1</td> <td>Red</td> </tr> </tbody> </table>			RB	RG	RR	Color	0	0	0	Black	0	0	1	Red	Sets the raster color of all blankings.												
		RB	RG	RR	Color																									
0	0	0	Black																											
0	0	1	Red																											
1	<table border="1"> <tbody> <tr> <td>0</td> <td>1</td> <td>0</td> <td>Green</td> </tr> <tr> <td>0</td> <td>1</td> <td>1</td> <td>Yellow</td> </tr> <tr> <td>1</td> <td>0</td> <td>0</td> <td>Blue</td> </tr> <tr> <td>1</td> <td>0</td> <td>1</td> <td>Magenta</td> </tr> <tr> <td>1</td> <td>1</td> <td>0</td> <td>Cyan</td> </tr> <tr> <td>1</td> <td>1</td> <td>1</td> <td>White</td> </tr> </tbody> </table>			0	1	0	Green	0	1	1	Yellow	1	0	0	Blue	1	0		1	Magenta	1	1	0	Cyan	1	1	1	White		
0	1	0	Green																											
0	1	1	Yellow																											
1	0	0	Blue																											
1	0	1	Magenta																											
1	1	0	Cyan																											
1	1	1	White																											
1	RG	0	<table border="1"> <thead> <tr> <th>FB</th> <th>FG</th> <th>FR</th> <th>Color</th> </tr> </thead> <tbody> <tr> <td>0</td> <td>0</td> <td>0</td> <td>Black</td> </tr> <tr> <td>0</td> <td>0</td> <td>1</td> <td>Red</td> </tr> </tbody> </table>			FB	FG	FR	Color	0	0	0	Black	0	0	1	Red	Sets the blanking color of the Border size, or the shadow size.												
		FB	FG	FR	Color																									
0	0	0	Black																											
0	0	1	Red																											
1	<table border="1"> <tbody> <tr> <td>0</td> <td>1</td> <td>0</td> <td>Green</td> </tr> <tr> <td>0</td> <td>1</td> <td>1</td> <td>Yellow</td> </tr> <tr> <td>1</td> <td>0</td> <td>0</td> <td>Blue</td> </tr> <tr> <td>1</td> <td>0</td> <td>1</td> <td>Magenta</td> </tr> <tr> <td>1</td> <td>1</td> <td>0</td> <td>Cyan</td> </tr> <tr> <td>1</td> <td>1</td> <td>1</td> <td>White</td> </tr> </tbody> </table>			0	1	0	Green	0	1	1	Yellow	1	0	0	Blue	1	0		1	Magenta	1	1	0	Cyan	1	1	1	White		
0	1	0	Green																											
0	1	1	Yellow																											
1	0	0	Blue																											
1	0	1	Magenta																											
1	1	0	Cyan																											
1	1	1	White																											
2	RB	0	<table border="1"> <tbody> <tr> <td>0</td> <td>1</td> <td>0</td> <td>Green</td> </tr> <tr> <td>0</td> <td>1</td> <td>1</td> <td>Yellow</td> </tr> <tr> <td>1</td> <td>0</td> <td>0</td> <td>Blue</td> </tr> <tr> <td>1</td> <td>0</td> <td>1</td> <td>Magenta</td> </tr> <tr> <td>1</td> <td>1</td> <td>0</td> <td>Cyan</td> </tr> <tr> <td>1</td> <td>1</td> <td>1</td> <td>White</td> </tr> </tbody> </table>			0	1	0	Green	0	1	1	Yellow	1	0	0	Blue	1	0	1	Magenta	1	1	0	Cyan	1	1	1	White	Sets the blanking color of the Border size, or the shadow size.
		0	1	0	Green																									
0	1	1	Yellow																											
1	0	0	Blue																											
1	0	1	Magenta																											
1	1	0	Cyan																											
1	1	1	White																											
1	<table border="1"> <tbody> <tr> <td>0</td> <td>1</td> <td>0</td> <td>Green</td> </tr> <tr> <td>0</td> <td>1</td> <td>1</td> <td>Yellow</td> </tr> <tr> <td>1</td> <td>0</td> <td>0</td> <td>Blue</td> </tr> <tr> <td>1</td> <td>0</td> <td>1</td> <td>Magenta</td> </tr> <tr> <td>1</td> <td>1</td> <td>0</td> <td>Cyan</td> </tr> <tr> <td>1</td> <td>1</td> <td>1</td> <td>White</td> </tr> </tbody> </table>			0	1	0	Green	0	1	1	Yellow	1	0	0	Blue	1	0	1	Magenta	1	1	0	Cyan	1	1	1	White			
0	1	0	Green																											
0	1	1	Yellow																											
1	0	0	Blue																											
1	0	1	Magenta																											
1	1	0	Cyan																											
1	1	1	White																											
3	FR	0	<table border="1"> <thead> <tr> <th>HSZ10</th> <th>Horizontal direction size</th> </tr> </thead> <tbody> <tr> <td>0</td> <td>1T/dot</td> </tr> <tr> <td>1</td> <td>2T/dot</td> </tr> </tbody> </table>			HSZ10	Horizontal direction size	0	1T/dot	1	2T/dot	Character size setting in the horizontal direction for the first line. T : Display frequency cycle																		
		HSZ10	Horizontal direction size																											
0	1T/dot																													
1	2T/dot																													
1	<table border="1"> <tbody> <tr> <td>0</td> <td>1</td> <td>0</td> <td>Green</td> </tr> <tr> <td>0</td> <td>1</td> <td>1</td> <td>Yellow</td> </tr> <tr> <td>1</td> <td>0</td> <td>0</td> <td>Blue</td> </tr> <tr> <td>1</td> <td>0</td> <td>1</td> <td>Magenta</td> </tr> <tr> <td>1</td> <td>1</td> <td>0</td> <td>Cyan</td> </tr> <tr> <td>1</td> <td>1</td> <td>1</td> <td>White</td> </tr> </tbody> </table>			0	1	0	Green	0	1	1	Yellow	1	0	0	Blue	1	0	1	Magenta	1	1	0	Cyan	1	1	1	White			
0	1	0	Green																											
0	1	1	Yellow																											
1	0	0	Blue																											
1	0	1	Magenta																											
1	1	0	Cyan																											
1	1	1	White																											
4	FG	0	<table border="1"> <thead> <tr> <th>HSZ20</th> <th>Horizontal direction size</th> </tr> </thead> <tbody> <tr> <td>0</td> <td>1T/dot</td> </tr> <tr> <td>1</td> <td>2T/dot</td> </tr> </tbody> </table>			HSZ20	Horizontal direction size	0	1T/dot	1	2T/dot	Character size setting in the horizontal direction for the 2nd line to 12th line. T : Display frequency cycle																		
		HSZ20	Horizontal direction size																											
0	1T/dot																													
1	2T/dot																													
1	<table border="1"> <tbody> <tr> <td>0</td> <td>1</td> <td>0</td> <td>Green</td> </tr> <tr> <td>0</td> <td>1</td> <td>1</td> <td>Yellow</td> </tr> <tr> <td>1</td> <td>0</td> <td>0</td> <td>Blue</td> </tr> <tr> <td>1</td> <td>0</td> <td>1</td> <td>Magenta</td> </tr> <tr> <td>1</td> <td>1</td> <td>0</td> <td>Cyan</td> </tr> <tr> <td>1</td> <td>1</td> <td>1</td> <td>White</td> </tr> </tbody> </table>			0	1	0	Green	0	1	1	Yellow	1	0	0	Blue	1	0	1	Magenta	1	1	0	Cyan	1	1	1	White			
0	1	0	Green																											
0	1	1	Yellow																											
1	0	0	Blue																											
1	0	1	Magenta																											
1	1	0	Cyan																											
1	1	1	White																											
5	FB	0	<table border="1"> <thead> <tr> <th>MODE1</th> <th>MODE0</th> <th>Display mode</th> </tr> </thead> <tbody> <tr> <td>0</td> <td>0</td> <td>Standard (Note4)</td> </tr> <tr> <td>0</td> <td>1</td> <td>AND</td> </tr> <tr> <td>1</td> <td>0</td> <td>EXOR</td> </tr> <tr> <td>1</td> <td>1</td> <td>OR</td> </tr> </tbody> </table>			MODE1	MODE0	Display mode	0	0	Standard (Note4)	0	1	AND	1	0	EXOR	1	1	OR	Sets the display mode for when 2 pages are displayed at the same time. See "DISPLAY FORM 2". MODE1(address12816) .									
		MODE1	MODE0	Display mode																										
0	0	Standard (Note4)																												
0	1	AND																												
1	0	EXOR																												
1	1	OR																												
1	<table border="1"> <tbody> <tr> <td>0</td> <td>1</td> <td>0</td> <td>Green</td> </tr> <tr> <td>0</td> <td>1</td> <td>1</td> <td>Yellow</td> </tr> <tr> <td>1</td> <td>0</td> <td>0</td> <td>Blue</td> </tr> <tr> <td>1</td> <td>0</td> <td>1</td> <td>Magenta</td> </tr> <tr> <td>1</td> <td>1</td> <td>0</td> <td>Cyan</td> </tr> <tr> <td>1</td> <td>1</td> <td>1</td> <td>White</td> </tr> </tbody> </table>			0	1	0	Green	0	1	1	Yellow	1	0	0	Blue	1	0	1	Magenta	1	1	0	Cyan	1	1	1	White			
0	1	0	Green																											
0	1	1	Yellow																											
1	0	0	Blue																											
1	0	1	Magenta																											
1	1	0	Cyan																											
1	1	1	White																											
6	TEST6	0	It should be fixed to "0".																											
		1	Can not be used.																											
7	TEST7	0	It should be fixed to "0".																											
		1	Can not be used.																											
8	TEST8	0	It should be fixed to "0".																											
		1	Can not be used.																											
9	BETA14	0	Matrix-outline display (12 X 18 dot)																											
		1	Matrix-outline display (14 X 18 dot)																											
A	HSZ10	0	<table border="1"> <thead> <tr> <th>HSZ10</th> <th>Horizontal direction size</th> </tr> </thead> <tbody> <tr> <td>0</td> <td>1T/dot</td> </tr> <tr> <td>1</td> <td>2T/dot</td> </tr> </tbody> </table>			HSZ10	Horizontal direction size	0	1T/dot	1	2T/dot	Character size setting in the horizontal direction for the first line. T : Display frequency cycle																		
		HSZ10	Horizontal direction size																											
0	1T/dot																													
1	2T/dot																													
1	<table border="1"> <tbody> <tr> <td>0</td> <td>1</td> <td>0</td> <td>Green</td> </tr> <tr> <td>0</td> <td>1</td> <td>1</td> <td>Yellow</td> </tr> <tr> <td>1</td> <td>0</td> <td>0</td> <td>Blue</td> </tr> <tr> <td>1</td> <td>0</td> <td>1</td> <td>Magenta</td> </tr> <tr> <td>1</td> <td>1</td> <td>0</td> <td>Cyan</td> </tr> <tr> <td>1</td> <td>1</td> <td>1</td> <td>White</td> </tr> </tbody> </table>			0	1	0	Green	0	1	1	Yellow	1	0	0	Blue	1	0	1	Magenta	1	1	0	Cyan	1	1	1	White			
0	1	0	Green																											
0	1	1	Yellow																											
1	0	0	Blue																											
1	0	1	Magenta																											
1	1	0	Cyan																											
1	1	1	White																											
B	TEST11	0	It should be fixed to "0".																											
		1	Can not be used.																											
C	HSZ20	0	<table border="1"> <thead> <tr> <th>HSZ20</th> <th>Horizontal direction size</th> </tr> </thead> <tbody> <tr> <td>0</td> <td>1T/dot</td> </tr> <tr> <td>1</td> <td>2T/dot</td> </tr> </tbody> </table>			HSZ20	Horizontal direction size	0	1T/dot	1	2T/dot	Character size setting in the horizontal direction for the 2nd line to 12th line. T : Display frequency cycle																		
		HSZ20	Horizontal direction size																											
0	1T/dot																													
1	2T/dot																													
1	<table border="1"> <tbody> <tr> <td>0</td> <td>1</td> <td>0</td> <td>Green</td> </tr> <tr> <td>0</td> <td>1</td> <td>1</td> <td>Yellow</td> </tr> <tr> <td>1</td> <td>0</td> <td>0</td> <td>Blue</td> </tr> <tr> <td>1</td> <td>0</td> <td>1</td> <td>Magenta</td> </tr> <tr> <td>1</td> <td>1</td> <td>0</td> <td>Cyan</td> </tr> <tr> <td>1</td> <td>1</td> <td>1</td> <td>White</td> </tr> </tbody> </table>			0	1	0	Green	0	1	1	Yellow	1	0	0	Blue	1	0	1	Magenta	1	1	0	Cyan	1	1	1	White			
0	1	0	Green																											
0	1	1	Yellow																											
1	0	0	Blue																											
1	0	1	Magenta																											
1	1	0	Cyan																											
1	1	1	White																											
D	TEST12	0	It should be fixed to "0".																											
		1	Can not be used.																											
E	MODE0 (Note 3)	0	<table border="1"> <thead> <tr> <th>MODE1</th> <th>MODE0</th> <th>Display mode</th> </tr> </thead> <tbody> <tr> <td>0</td> <td>0</td> <td>Standard (Note4)</td> </tr> <tr> <td>0</td> <td>1</td> <td>AND</td> </tr> <tr> <td>1</td> <td>0</td> <td>EXOR</td> </tr> <tr> <td>1</td> <td>1</td> <td>OR</td> </tr> </tbody> </table>			MODE1	MODE0	Display mode	0	0	Standard (Note4)	0	1	AND	1	0	EXOR	1	1	OR	Sets the display mode for when 2 pages are displayed at the same time. See "DISPLAY FORM 2". MODE1(address12816) .									
		MODE1	MODE0	Display mode																										
0	0	Standard (Note4)																												
0	1	AND																												
1	0	EXOR																												
1	1	OR																												
1	<table border="1"> <tbody> <tr> <td>0</td> <td>1</td> <td>0</td> <td>Green</td> </tr> <tr> <td>0</td> <td>1</td> <td>1</td> <td>Yellow</td> </tr> <tr> <td>1</td> <td>0</td> <td>0</td> <td>Blue</td> </tr> <tr> <td>1</td> <td>0</td> <td>1</td> <td>Magenta</td> </tr> <tr> <td>1</td> <td>1</td> <td>0</td> <td>Cyan</td> </tr> <tr> <td>1</td> <td>1</td> <td>1</td> <td>White</td> </tr> </tbody> </table>			0	1	0	Green	0	1	1	Yellow	1	0	0	Blue	1	0	1	Magenta	1	1	0	Cyan	1	1	1	White			
0	1	0	Green																											
0	1	1	Yellow																											
1	0	0	Blue																											
1	0	1	Magenta																											
1	1	0	Cyan																											
1	1	1	White																											

Notes 1. The mark ○ around the status value means the reset status by the "L" level is input to AC pin.

2. The page in which data is written is controlled by the DAF bit. When set to "0", data is written into page 0, whereas when set to "1", data is written into page 1.

3. Registers marked with (Note 3) are found only in page 0, therefore the register value does not change when the DAF bit is set to "1".

4. 2 way settings are available by POPUP (address 12616).

SCREEN CHARACTER and PATTERN DISPLAY CONTROLLERS

(9) Address 128₁₆

DA	Register	Contents		Remarks																	
		Status	Function																		
0	BCOL	0	Blanking of BLK0, BLK1	Sets all raster blanking																	
		1	All raster blanking																		
1	B/ \bar{F} (Note 3)	0	Synchronize with the leading edge of horizontal synchronization.	Synchronize with the front porch or back porch of the horizontal synchronization signal.																	
		1	Synchronize with the trailing edge of horizontal synchronization.																		
2	VMASK (Note 3)	0	Do not mask by VERT input signal	Set mask at phase comparison operating.																	
		1	Mask by VERT input signal																		
3	POLV (Note 3)	0	VERT pin is negative polarity	Set VERT pin polarity.																	
		1	VERT pin is positive polarity																		
4	POLH (Note 3)	0	HOR pin is negative polarity	Set HOR pin polarity.																	
		1	HOR pin is positive polarity																		
5	BLK0	0	<table border="1"> <thead> <tr> <th>BLINK1</th> <th>BLINK0</th> <th>Blanking mode</th> </tr> </thead> <tbody> <tr> <td>0</td> <td>0</td> <td>Matrix-outline size</td> </tr> <tr> <td>0</td> <td>1</td> <td>Character size</td> </tr> <tr> <td>1</td> <td>0</td> <td>Border size</td> </tr> <tr> <td>1</td> <td>1</td> <td>Matrix-outline size</td> </tr> </tbody> </table>	BLINK1	BLINK0	Blanking mode	0	0	Matrix-outline size	0	1	Character size	1	0	Border size	1	1	Matrix-outline size	Set blanking mode. See "DISPLAY SHAPE 2".		
BLINK1	BLINK0	Blanking mode																			
0	0	Matrix-outline size																			
0	1	Character size																			
1	0	Border size																			
1	1	Matrix-outline size																			
1																					
6	BLK1	0	(When DSPn (address 124 ₁₆) = "0")																		
1																					
7	SYAD	0	Border display of character	See "DISPLAY FORM1 (2)".																	
		1	Shadow display of character																		
8	RAMERS	0	RAM not erased	There is no need to reset because there is no register for this bit.																	
		1	RAM erased																		
9	TEST35	0	It should be fixed to "0".	Fix the page 1 memory (TEST13) to "0".																	
		1	Can not be used.																		
A	DSPON	0	Display OFF																		
		1	Display ON																		
B	BLINK0	0	<table border="1"> <thead> <tr> <th colspan="2">BLINK</th> <th>Duty</th> </tr> </thead> <tbody> <tr> <td>1</td> <td>0</td> <td rowspan="2">Blinking OFF</td> </tr> <tr> <td>0</td> <td>0</td> </tr> <tr> <td>0</td> <td>1</td> <td>25%</td> </tr> <tr> <td>1</td> <td>0</td> <td>50%</td> </tr> <tr> <td>1</td> <td>1</td> <td>75%</td> </tr> </tbody> </table>	BLINK		Duty	1	0	Blinking OFF	0	0	0	1	25%	1	0	50%	1	1	75%	Set blinking duty ratio.
BLINK		Duty																			
1	0	Blinking OFF																			
0	0																				
0	1	25%																			
1	0	50%																			
1	1	75%																			
1																					
C	BLINK1	0																			
		1																			
D	BLINK2	0	Divided into 64 of vertical synchronous signal	Set blinking frequency.																	
		1	Divided into 32 of vertical synchronous signal																		
E	MODE1 (Note 3)	0	For setting, see MODE0 (address 127 ₁₆).	Sets the display mode for when 2 pages are displayed at the same time.																	
		1																			

- Notes 1. The mark 0 around the status value means the reset status by the "L" level is input to AC pin.
 2. The page in which data is written is controlled by the DAF bit. When set to "0", data is written into page 0, whereas when set to "1", data is written into page 1.
 3. Registers marked with (Note 3) are found only in page 0, therefore the register value does not change when the DAF bit is set to "1".

SCREEN CHARACTER and PATTERN DISPLAY CONTROLLERS

DISPLAY FORM 1

M35049-XXXFP has the following four display forms.

(1) Blanking mode

Character size

: Blanking same as the character size.

Border size

: Blanking the background as a size from character.

Matrix-outline size

: Blanking the background 12 X18 dot.

All blanking size

: When set register BCOL to "1", all raster area is blanking.

The display mode and blanking mode can be set line-by-line, as follows, from registers BCOL, BLK1, BLK0 (address 128₁₆), DSP0 to DSP11 (address 124₁₆).

BCOL	BLK1	BLK0	Line of DSPn = "0"		Line of DSPn = "1"	
			Display mode	Blanking mode	Display mode	Blanking mode
0	0	0	All matrix-outline border display	All matrix-outline size	All matrix-outline display	All matrix-outline size
	0	1	Character display	Character size	Border display	Border size
	1	0	Border display	Border size	All matrix-outline display	All matrix-outlinesize
	1	1	All matrix-outline display	All matrix-outline size	Character display	Character size
1	0	0	All matrix-outline border display	All blanking size	All matrix-outline display	All blanking size
	0	1	Character display		Border display	
	1	0	Border display		All matrix-outline display	
	1	1	All matrix-outline display		Character display	

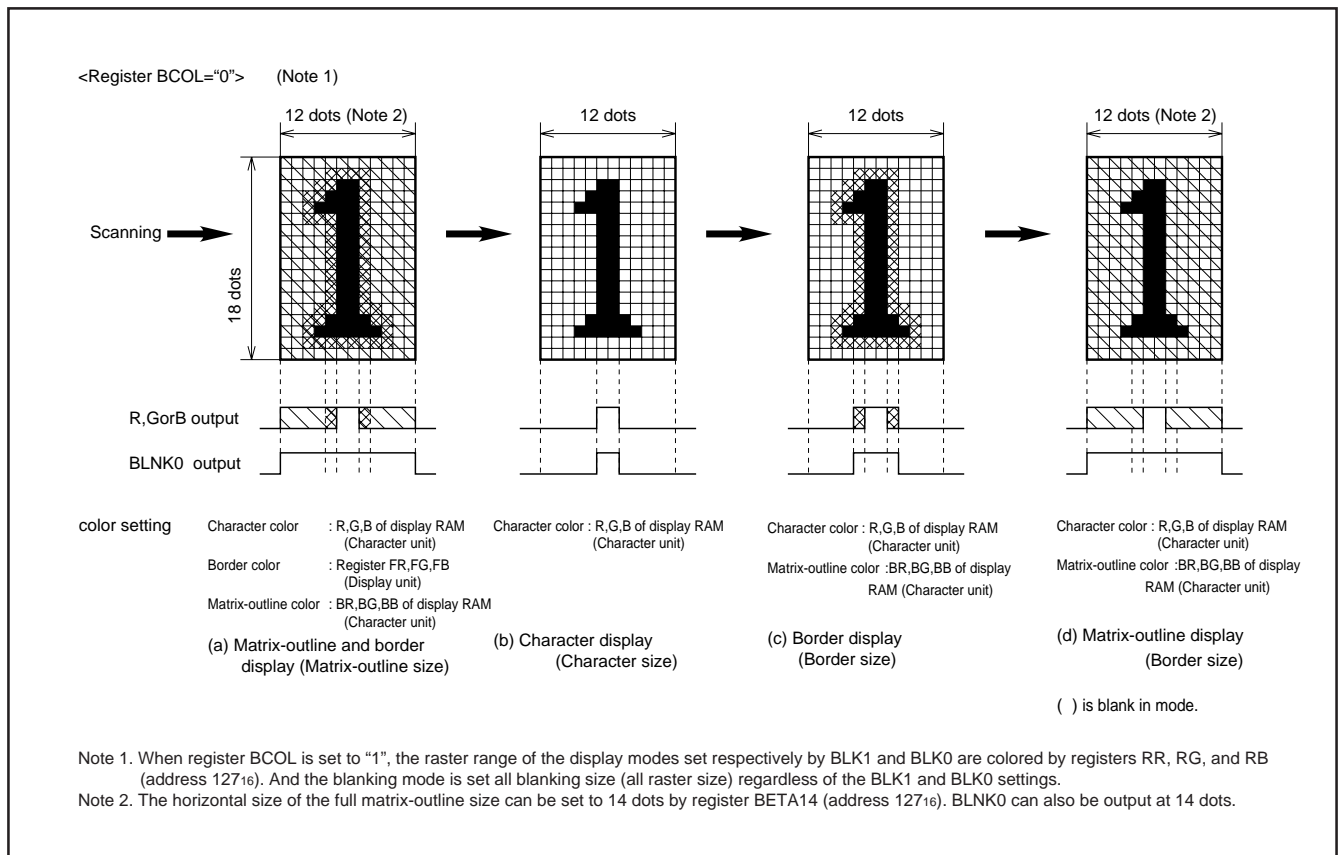

Fig. 4 Display form

SCREEN CHARACTER and PATTERN DISPLAY CONTROLLERS

(2) Shadow display

When border display mode, if set SYAD (address 128₁₆) = "0" to "1", it change to shadow display mode.

Border and shadow display are shown below.

Set shadow display color by BR, BG or BB of display RAM or by register FR, FG and FB (address 127₁₆).

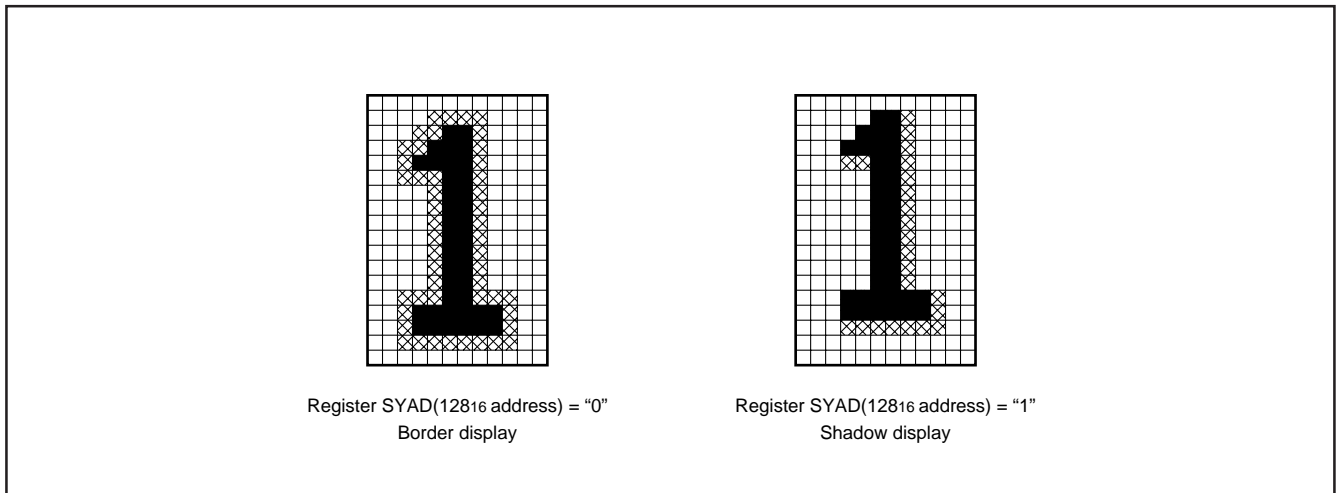

Fig. 5 Border and shadow display

DISPLAY FORM 2

This IC can display both page 0 and page 1 at the same time.

Page 0: Set the DAF bit in each addresses to "0".

Page 1: Set the DAF bit in each addresses to "1".

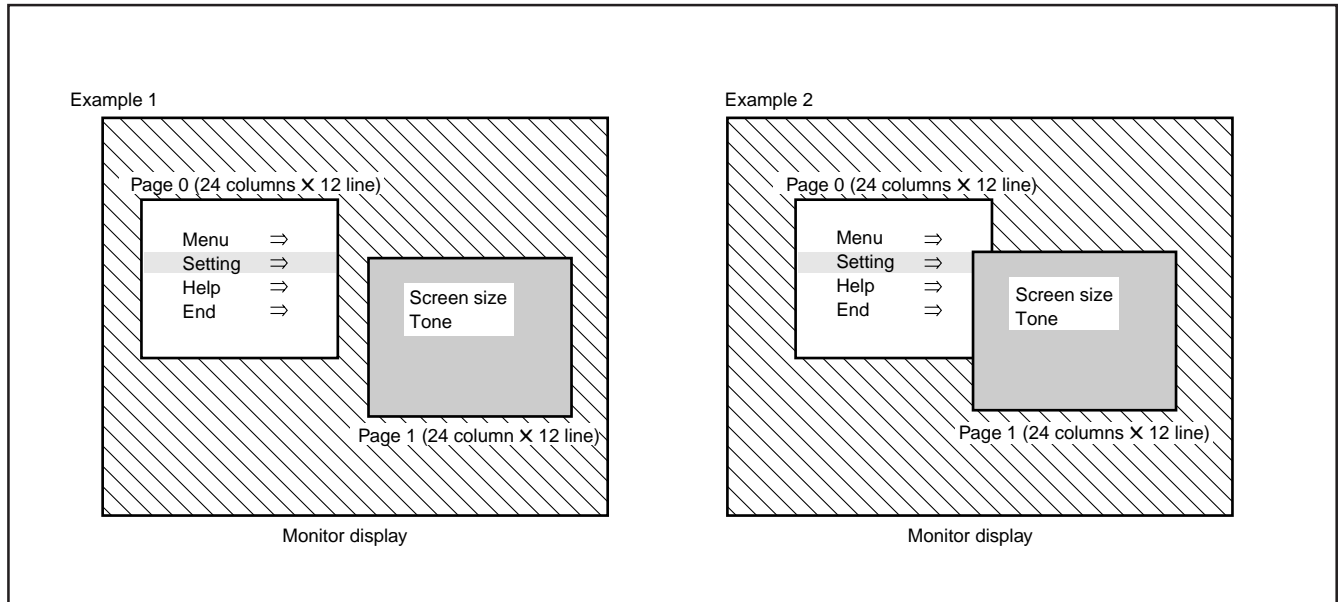

Fig.6 Example of 2 pages display

Example 1: Display position, display size, color, etc., can be freely set for each page, and the 2 pages can be displayed on top of each other or side-by-side.

Example 2: When the display range of the 2 pages overlap on the monitor screen, they can be displayed in the 5 below ways using registers MODE0 (address 127₁₆), MODE1 (address 128₁₆) and POPUP (address 126₁₆). (The POPUP register is effective only when MODE0 = "0" and MODE1 = "0".)

MODE1	MODE0	POPUP	Display mode
0	0	0	Standard (Page 1 priority)
		1	Standard (Page 0 priority)
0	1	—	AND
1	0	—	EXOR
1	1	—	OR

- (1) Standard (page 1 priority) ... Page 1 has priority in overlapping areas. Page 0 is not displayed in those areas.
- (2) Standard (page 0 priority) ... Page 0 has priority in overlapping areas. Page 1 is not displayed in those areas.
- (3) AND In overlapping areas, the RGB output of the 2 pages is AND processed and output.
- (4) EXOR In overlapping areas, the RGB output of the 2 pages is EXOR processed and output.
- (5) OR In overlapping areas, the RGB output of the 2 pages is OR processed and output.

CHARACTER FONT

Images are composed on a 12 X 18 dot matrix, and characters can be linked vertically and horizontally with other characters to allow the display the continuous symbols.

Character code FF16 is fixed as a blank without background. Therefore, cannot register a character font in this code.

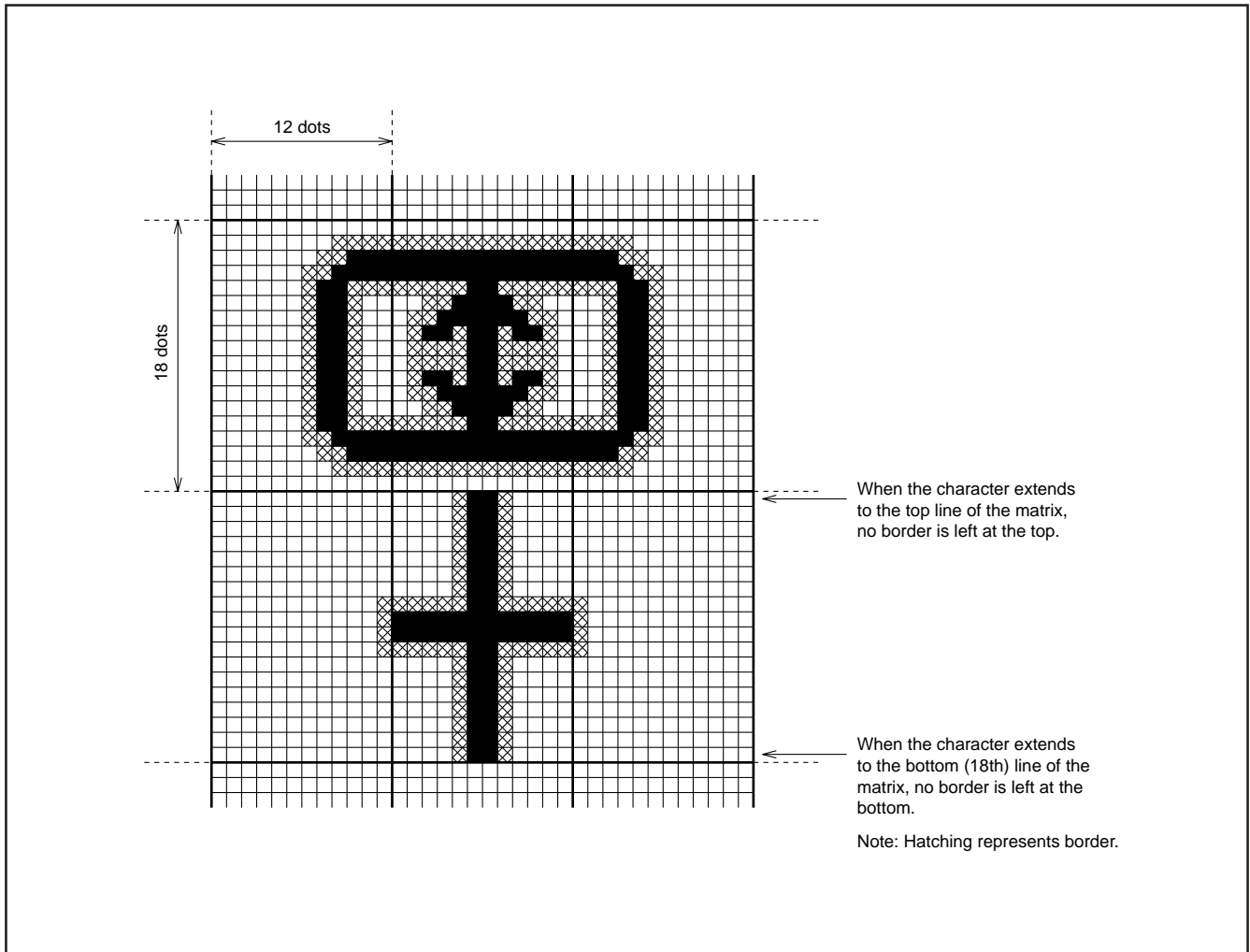

Fig.7 Example of border display

DATA INPUT EXAMPLE

Data of display RAM and display control registers can be set by the 16-bit serial input function. Example of data setting is shown in Figure 8.

Data input example (M35049-XXXFP)																Remarks		
Address/data	DAF (Note1)	DAE	DAD	DAC	DAB	DAA	DA9	DA8	DA7	DA6	DA5	DA4	DA3	DA2	DA1	DA0		
		200m sec hold														System set up		
Address	120 ₁₆	0	0	0	0	0	0	1	0	0	1	0	0	0	0	0	Address setting	
Data	120 ₁₆	0	0	0	0	0	0	0	0	0	0	0	0	0	0	0	Frequency value setting (Note2)	
Data	121 ₁₆	0	0	PTD7	PTD6	1	PTD4	1	PTD2	1	1	1	0	1	0	1	Output setting	
Data	122 ₁₆	0	0	0	0	0	0	0	HP8	HP7	HP6	HP5	HP4	HP3	HP2	HP1	HP0	Horizontal display location setting
Data	123 ₁₆	0	0	0	0	0	0	0	0	VP7	VP6	VP5	VP4	VP3	VP2	VP1	VP0	Vertical display location setting
Data	124 ₁₆	0	1	0	0	0	0	0	0	0	0	0	0	0	0	0	0	Display form setting
Data	125 ₁₆	0	0	0	0	0	0	0	0	0	0	0	0	0	0	0	0	Character size setting
Data	126 ₁₆	0	0	0	0	0	0	0	0	0	0	0	0	0	0	0	0	Character size setting
Data	127 ₁₆	0	0	0	0	0	0	0	0	0	0	0	0	0	0	0	0	Color, character size setting
Data	128 ₁₆	0	0	0	0	0	0	0	0	0	0	0	POLH	POLV	0	0	0	Page 0 display OFF
Address	122 ₁₆	0	0	0	0	0	0	1	0	0	1	0	0	0	1	0	Address setting	
Data	122 ₁₆	1	0	0	0	0	0	0	HP8	HP7	HP6	HP5	HP4	HP3	HP2	HP1	HP0	Horizontal display location setting
Data	123 ₁₆	1	0	0	0	0	0	0	0	VP7	VP6	VP5	VP4	VP3	VP2	VP1	VP0	Vertical display location setting
Data	124 ₁₆	1	0	0	0	0	0	0	0	0	0	0	0	0	0	0	0	Display form setting
Data	125 ₁₆	1	0	0	0	0	0	0	0	0	0	0	0	0	0	0	0	Character size setting
Data	126 ₁₆	1	0	0	0	0	0	0	0	0	0	0	0	0	0	0	0	Character size setting
Data	127 ₁₆	1	0	0	0	0	0	0	0	0	0	0	0	0	0	0	0	Color, character size setting
Data	128 ₁₆	1	0	0	0	0	0	0	0	0	0	0	0	0	0	0	0	Page 1 display OFF
Data	000 ₁₆	0	BB	BG	BR	BLINK	B	G	R	C7	C6	C5	C4	C3	C2	C1	C0	Character setting
⋮	⋮	Background coloring			Blink-ing	Character color			Character code									
Data	11F ₁₆	0	BB	BG	BR	BLINK	B	G	R	C7	C6	C5	C4	C3	C2	C1	C0	Character setting
Address	000 ₁₆	0	0	0	0	0	0	0	0	0	0	0	0	0	0	0	0	
Data	000 ₁₆	1	BB	BG	BR	BLINK	B	G	R	C7	C6	C5	C4	C3	C2	C1	C0	Character setting
⋮	⋮	Background coloring			Blink-ing	Character color			Character code									
Data	11F ₁₆	1	BB	BG	BR	BLINK	B	0	R	C7	C6	C5	C4	C3	C2	C1	C0	
Address	128 ₁₆	0	0	0	0	0	0	0	1	0	0	1	0	1	0	0	0	Address setting
Data	128 ₁₆	1	0	0	0	0	1	0	0	0	1	1	0	0	0	0	0	Page 1 display ON Display form setting (Note 2)
Address	128 ₁₆	0	0	0	0	0	0	0	1	0	0	1	0	1	0	0	0	Address setting
Data	128 ₁₆	0	0	0	0	0	1	0	0	0	1	1	POLH	POLV	0	0	0	Page 0 display ON Display form setting (Note 2)

Notes 1 : The page in which data is written is controlled by the address. To write data into page 0, set "0". To write data into page 1, set "1".
 2 : Matrix-outline display in this data.
 3 : Input a continuous clock of constant period from the TCK pin.

Fig 8. Example of data setting

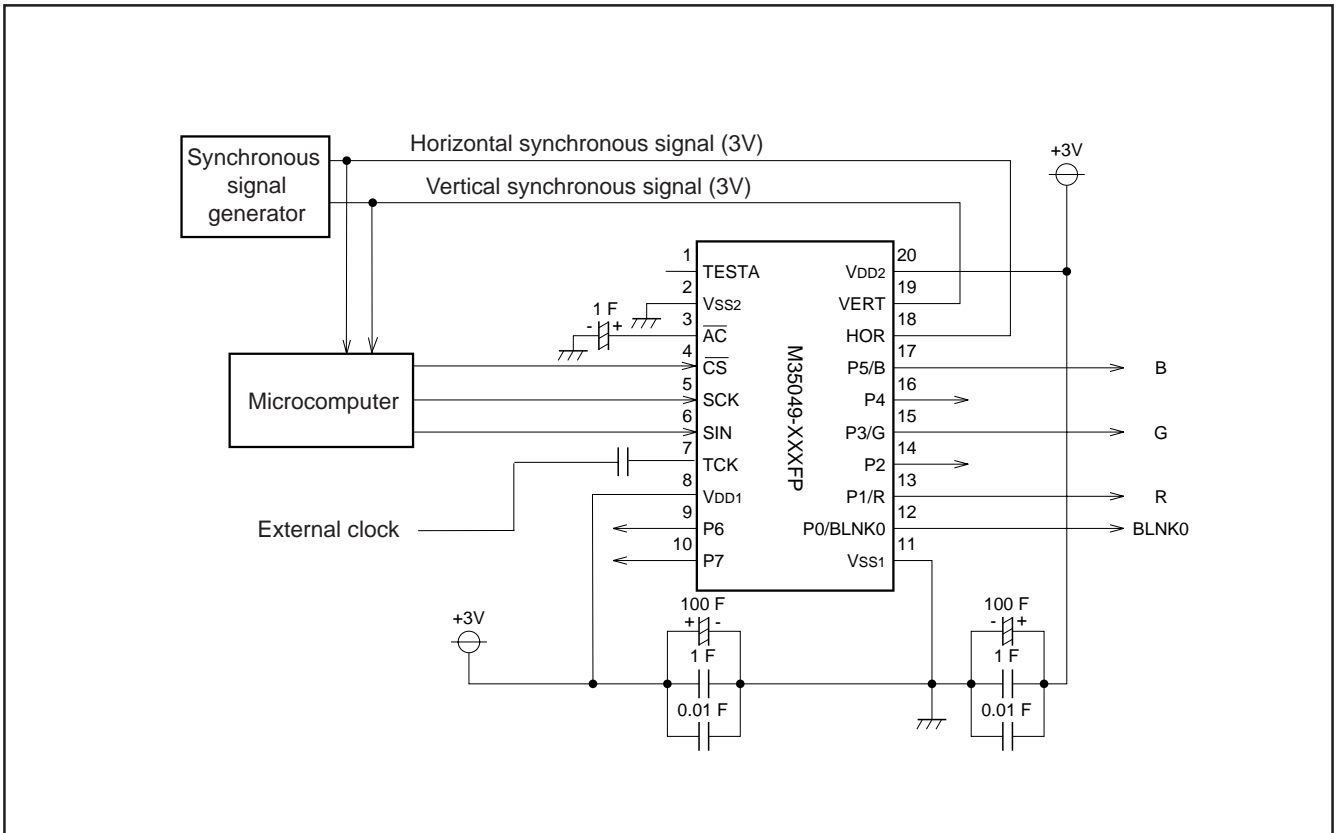

Fig. 9 Example of the M35049-XXXFP peripheral circuit

SERIAL DATA INPUT TIMING

- (1)Serial data should be input with the LSB first.
- (2)The address consists of 16 bits.
- (3)The data consists of 16 bits.
- (4)The 16 bits in the SCK after the CS signal has fallen are the address, and for succeeding input data, the address is incremented every 16 bits. Therefore, it is not necessary to input the address from the second data.

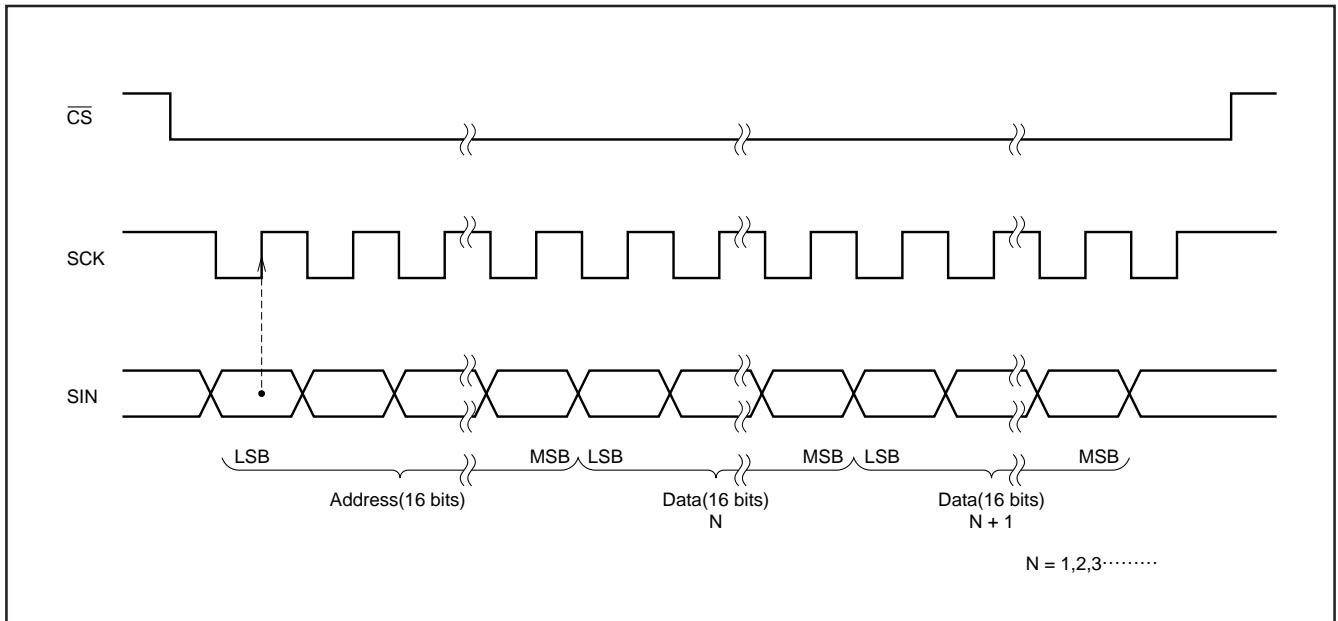

Fig.10 Serial input timing

TIMING REQUIREMENTS ($T_a = -20^{\circ}\text{C}$ to $+85^{\circ}\text{C}$, $V_{DD} = 2.2$ to 3.5V , unless otherwise noted)

Data input

Symbol	Parameter	Limits			Unit	Remarks
		Min.	Typ.	Max.		
$t_w(\text{SCK})$	SCK width	200	—	—	ns	See Figure 11
$t_{su}(\overline{\text{CS}})$	CS setup time	200	—	—	ns	
$t_h(\overline{\text{CS}})$	CS hold time	2	—	—	μs	
$t_{su}(\text{SIN})$	SIN setup time	200	—	—	ns	
$t_h(\text{SIN})$	SIN hold time	200	—	—	ns	
t_{word}	1 word writing time	10	—	—	μs	

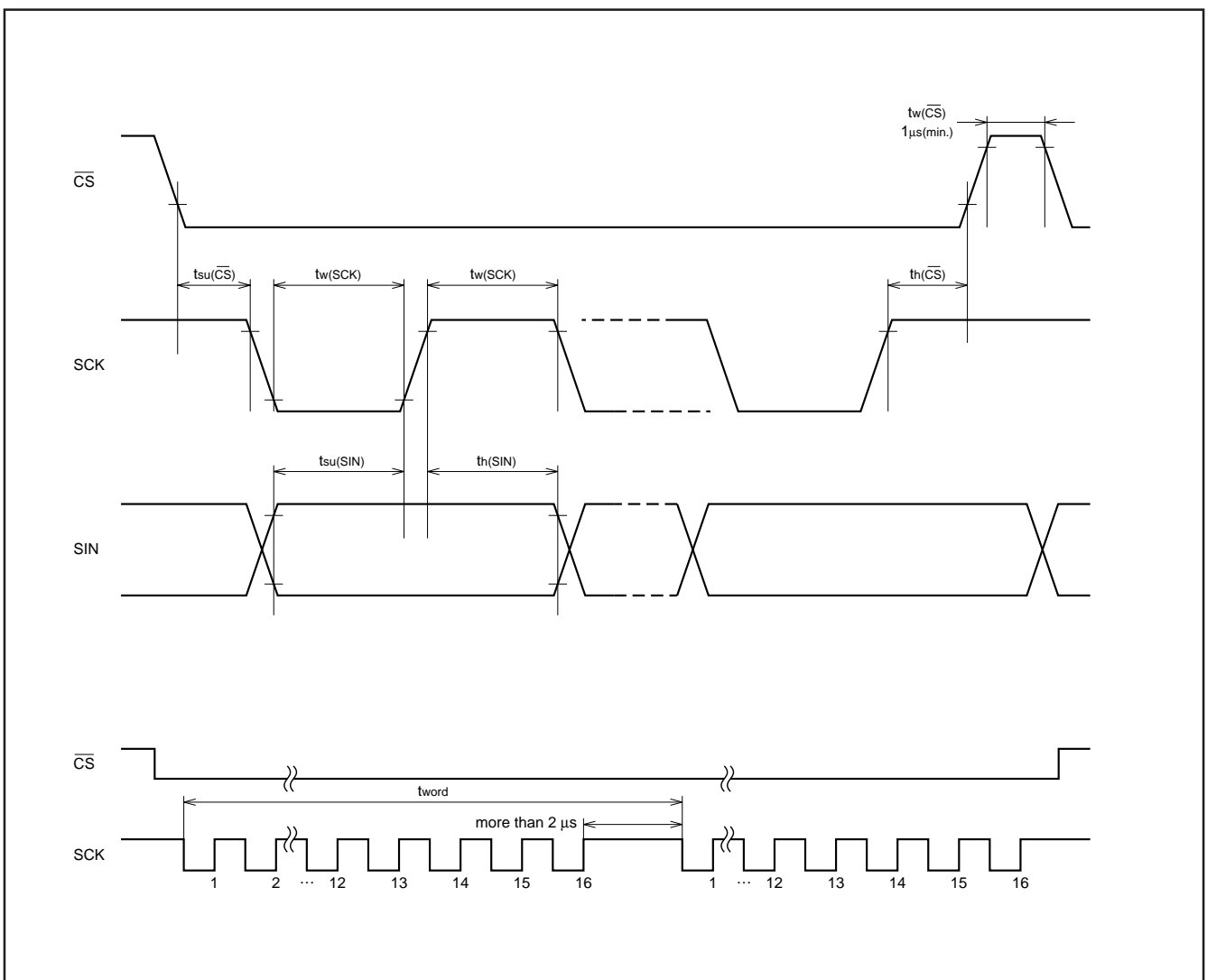

Fig. 11 Serial input timing requirements

SCREEN CHARACTER and PATTERN DISPLAY CONTROLLERS

ABSOLUTE MAXIMUM RATINGS

Symbol	Parameter	Conditions	Ratings	Unit
V _{DD}	Supply voltage	With respect to V _{SS} .	-0.3 to +4.0	V
V _I	Input voltage		V _{SS} - 0.3 ≤ V _I ≤ V _{DD} + 0.3	V
V _O	Output voltage		V _{SS} ≤ V _O ≤ V _{DD}	V
P _d	Power dissipation	T _a = +25°C	+300	mW
T _{opr}	Operating temperature		-20 to +85	°C
T _{stg}	Storage temperature		-40 to +125	°C

RECOMMENDED OPERATING CONDITIONS (V_{DD} = 3.00V, T_a = -20 to +85°C, unless otherwise noted)

Symbol	Parameter		Limits			Unit
			Min.	Typ.	Max.	
V _{DD}	Supply voltage		2.2	3.0	3.5	V
V _{IH}	"H" level input voltage	AC,CS,HOR,SIN,SCK,VERT	0.8V _{DD}	V _{DD}	V _{DD}	V
V _{IL}	"L" level input voltage	AC,CS,HOR,SIN,SCK,VERT	0	0	0.2V _{DD}	V
F _{OSC}	Oscillating frequency for display		6.3	—	16.0	MHz
H.sync	Horizontal synchronous signal input frequency		15.0	—	32.0	kHz

ELECTRICAL CHARACTERISTICS (V_{DD} = 3.00V, T_a = 25°C, unless otherwise noted)

Symbol	Parameter		Test conditions	Limits			Unit
				Min.	Typ.	Max.	
V _{DD}	Supply voltage		T _a = -20 to +85°C	2.20	3.00	3.50	V
I _{DD}	Supply current		V _{DD} = 3.00V	—	5	10	mA
V _{OH}	"H" level output voltage	P0 to P7 (Note1)	V _{DD} = 2.20V, I _{OH} = -0.1mA	1.80	—	—	V
V _{OL}	"L" level output voltage	P0 to P7 (Note2)	V _{DD} = 2.20V, I _{OH} = 0.1mA	—	—	0.4	V
R _I	Pull-up resistance AC		V _{DD} = 3.00V	30	—	150	kΩ
V _{TCK}	External clock input width		2.20V ≤ V _{DD} ≤ 3.50V	0.7V _{DD}	—	V _{DD}	V

Notes 1. The current from the IC must not exceed - 0.1 mA/port at any of the port pins (P0 to P7).
 2. The current flowing into the IC must not exceed 0.1 mA/port at any of port pins (P0 to P7).

NOTE FOR SUPPLYING POWER

(1)Timing of power supplying to AC pin

The internal circuit of M35049-XXXFP is reset when the level of the auto clear input pin AC is "L". This pin is hysteresis input with the pull-up resistor.

The timing about power supplying of AC pin is shown in Figure 12.

After supplying the power (VDD and VSS) to M35049-XXXFP and the supply voltage becomes more than $0.8 \times V_{DD}$, it needs to keep V_{IL} time; t_w of the AC pin for more than 1ms.

Start inputting from microcomputer after AC pin supply voltage becomes more than $0.8 \times V_{DD}$ and keeping 200ms wait time.

(2)Timing of power supplying to VDD1 and VDD2.

Supply power to VDD1 and VDD2 at the same time.

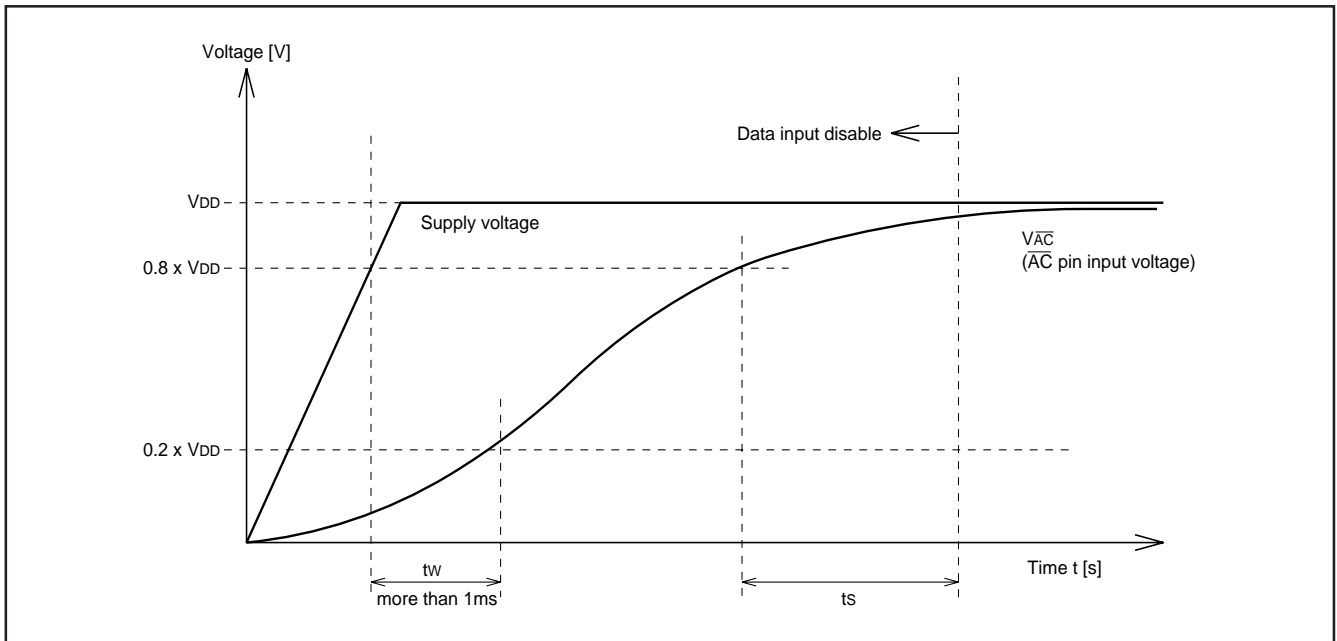

Fig. 12 Timing of power supplying to AC pin

PRECAUTION FOR USE

Notes on noise and latch-up

In order to avoid noise and latch-up, connect a bypass capacitor ($\approx 0.1\mu F$) directly between the V_{DD1} pin and V_{SS1} pin, and the V_{DD2} pin and V_{SS2} pin using a heavy wire.

Note for horizontal synchronous signal input to the HOR pin

Set horizontal synchronous signal edge* waveform timing to under 5ns and input to HOR pin.

Set only the side which set by B/F register waveform timing under 5ns and input to HOR pin.

*: Set front porch edge or back porch edge by B/F register (address 12816).

Note for external clock input to the TCK pin

Input to the TCK pin a constant-period continuous external clock that synchronizes with the horizontal synchronous signal. Never stop inputting the clock while displaying.

DATA REQUIRED FOR MASK ROM ORDERING

Please send the following data for mask orders.

- (1) M35049-XXXFP mask ROM order confirmation form
- (2) 20P2Q-A mask specification form
- (3) ROM data : EPROMs or floppy disks

*In the case of EPROMs, three sets of EPROMs are required per pattern.

*In the case of floppy disks, 3.5-inch 2HD disk (IBM format) is required per pattern.

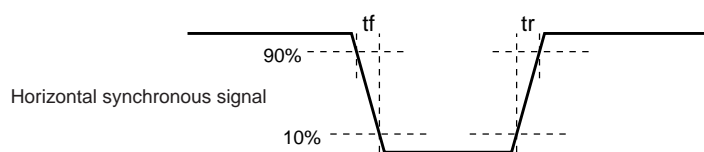

STANDARD ROM TYPE : M35049-001FP

M35049-001FP is a standard ROM type of M35049-XXXFP. The character patterns for 0 page are fixed to the contents of Figure 13 to 16, the character patterns for page 1 are fixed to the contents of Figure 17 to 20.

SCREEN CHARACTER and PATTERN DISPLAY CONTROLLERS

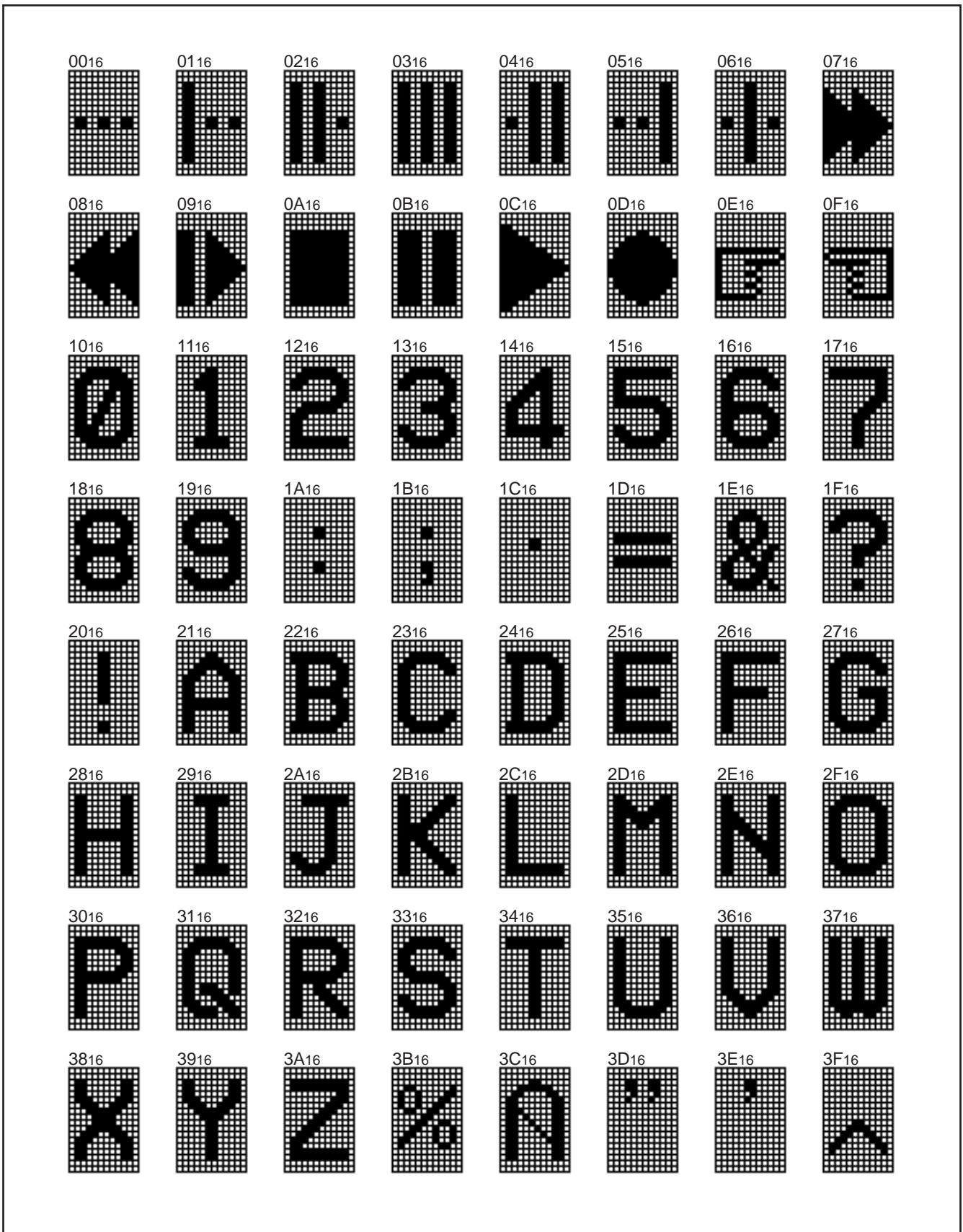

Fig. 13 M35049-001FP character pattern for page 0 (1)

SCREEN CHARACTER and PATTERN DISPLAY CONTROLLERS

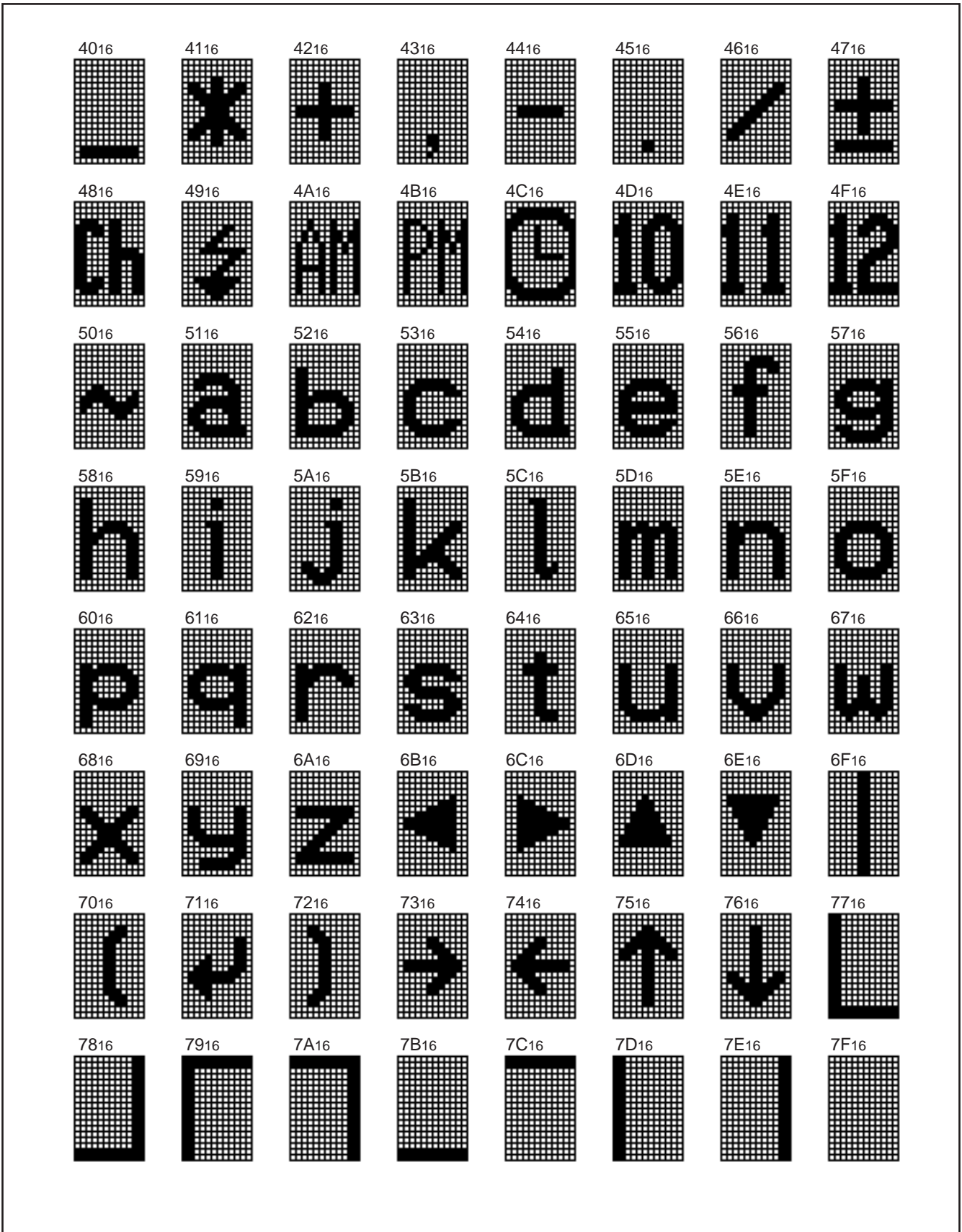

Fig. 14 M35049-001FP character pattern for page 0 (2)

SCREEN CHARACTER and PATTERN DISPLAY CONTROLLERS

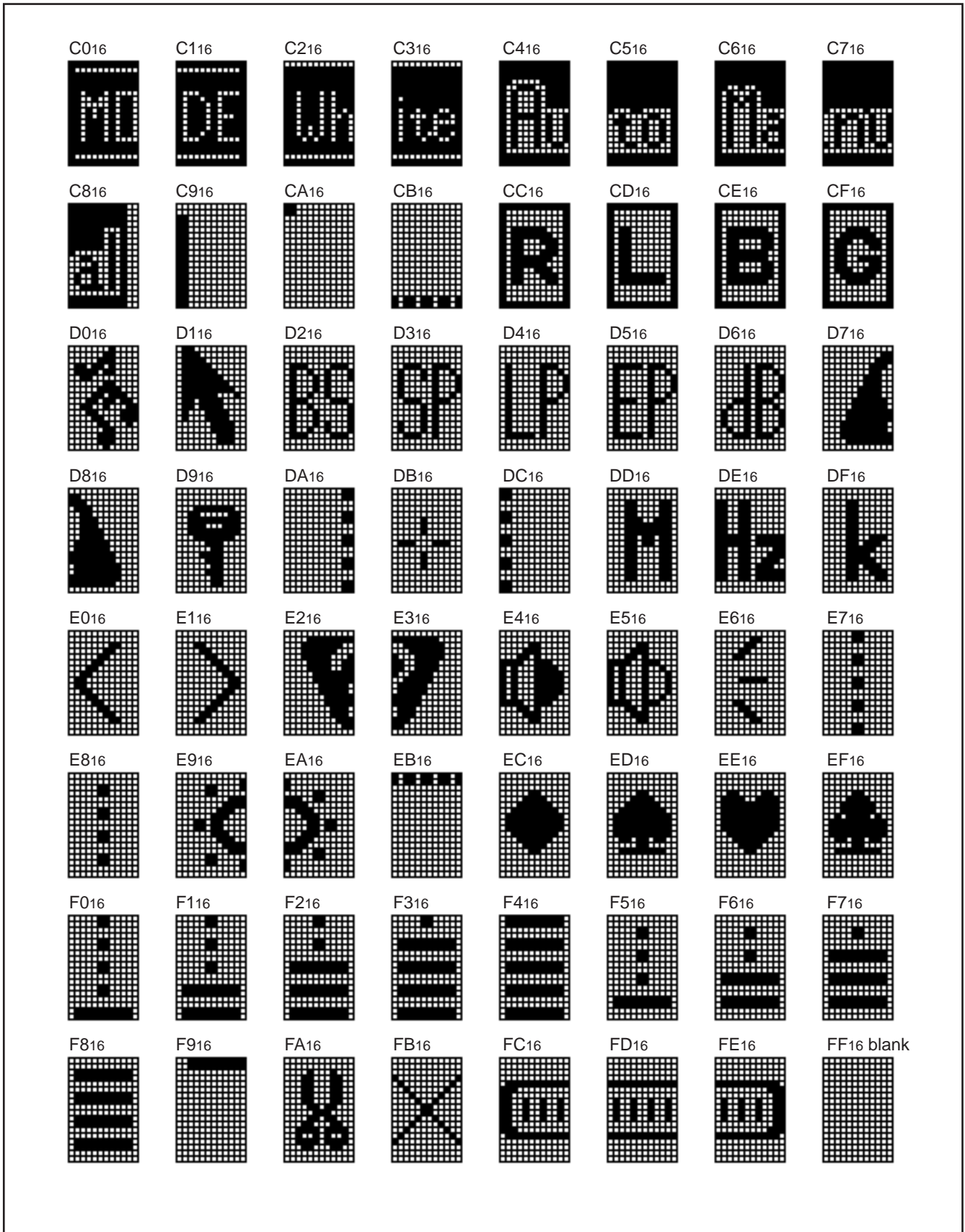

Fig. 16 M35049-001FP character pattern for page 0 (4)

SCREEN CHARACTER and PATTERN DISPLAY CONTROLLERS

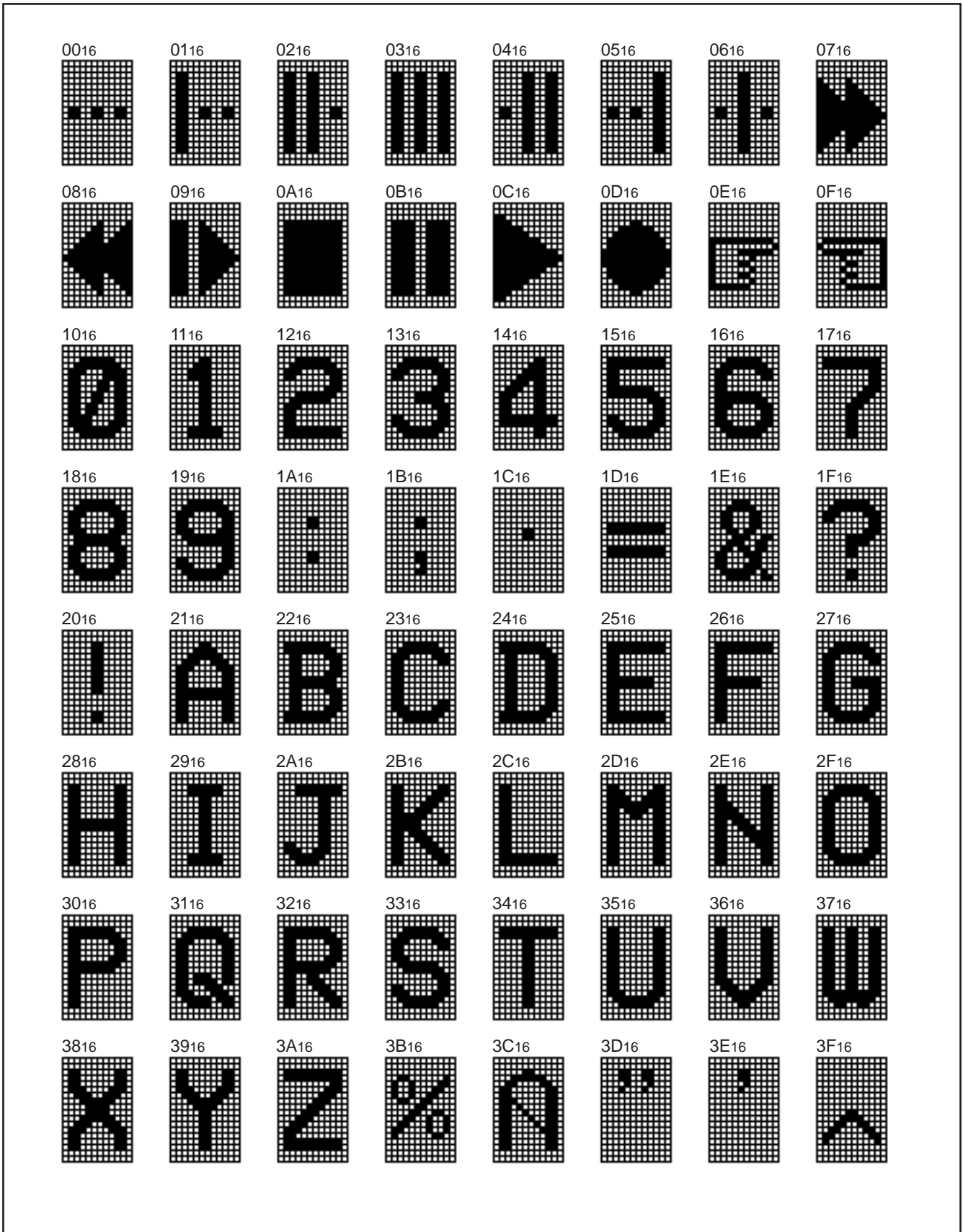

Fig. 17 M35049-001FP character pattern for page 1 (1)

SCREEN CHARACTER and PATTERN DISPLAY CONTROLLERS

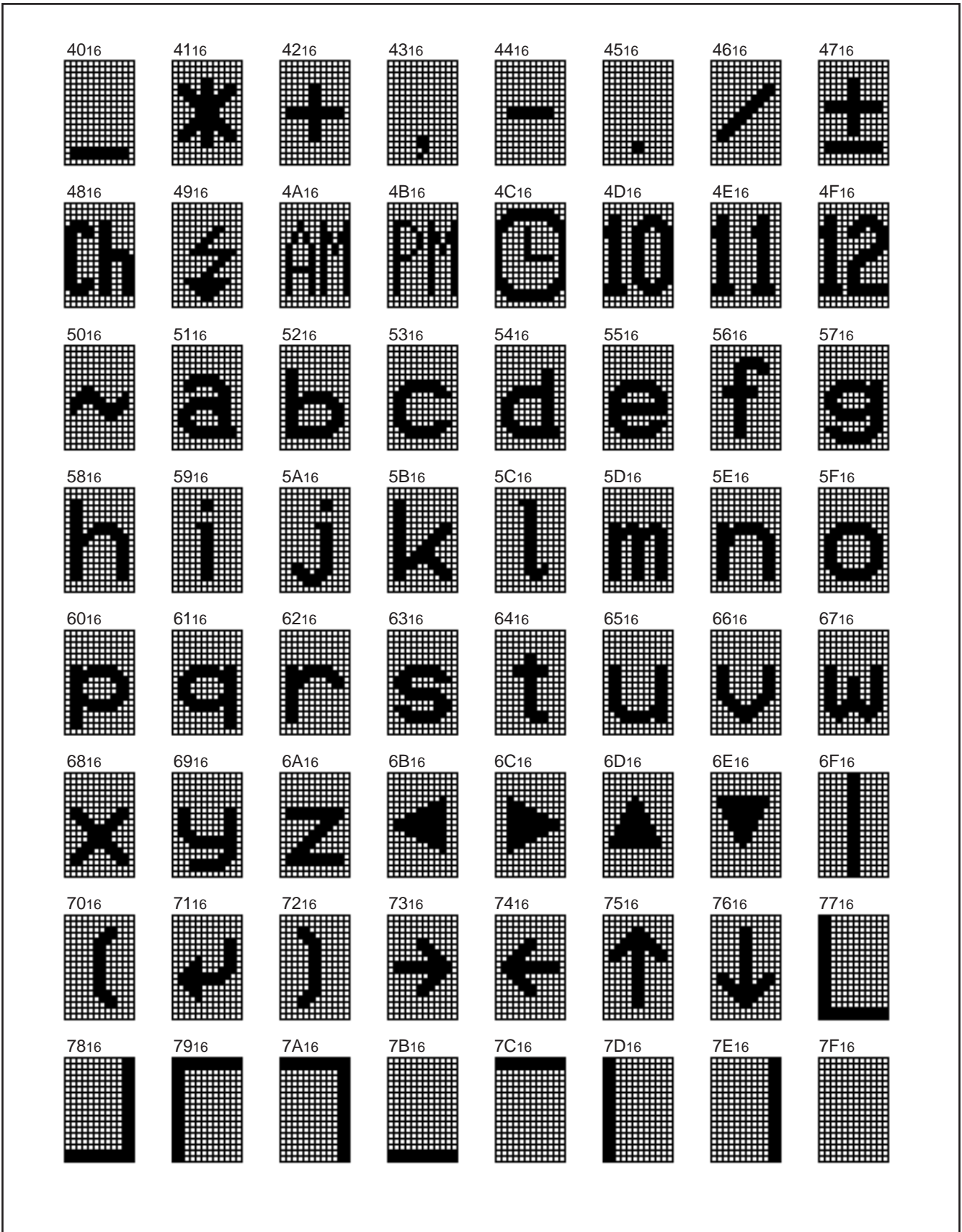

Fig. 18 M35049-001FP character pattern for page 1 (2)

SCREEN CHARACTER and PATTERN DISPLAY CONTROLLERS



Fig. 20 M35049-001FP character pattern for page 1 (4)

SCREEN CHARACTER and PATTERN DISPLAY CONTROLLERS

GZZ-SH54-38B<8XA0>

Mask ROM number	
-----------------	--

**MASK ROM CONFIRMATION FORM
SCREEN DISPLAY IC M35049-XXXFP
MITSUBISHI ELECTRIC**

Receipt	Data :	
	Section head signature	Supervisor signature

Note : Please fill in all items marked *, .

* Customer	Company name	TEL ()	Issuance signature	Submitted by	Supervisor
	Data issued	Date :			

* 1. Confirmation

Confirm the Character Font Preparation Program in Mitsubishi Sales Sites.
Three EPROMs are required for each pattern if this order is performed by EPROMs.
One floppy disk is required for each pattern if this order is performed by a floppy disk.

Ordering by EPROMs

If at least two of the three sets of EPROMs submitted contain identical data, we will produce masks based on this data. We shall assume the responsibility for errors only if the mask ROM data on the products we produce differs from this data. Thus, extreme care must be taken to verify the data in the submitted EPROMs (27512 type used).

- (1) The font data prepared by the Character Font Preparation Program is saved as a binary type object file (addresses 0000h to FFFFh) and a hex type object file . Three sets of these EPROMs are required.
- (2) Attach the erase protect seals on three EPROMs. Each seal bears the type name (M35049), and ROM No. (-...FP).

Checksum code for entire EPROM

--	--	--	--

 (hexadecimal notation)

Save file name

M	0	4	9	R			
---	---	---	---	---	--	--	--

 .

V			
---	--	--	--

 (equal or less than eight characters)

Ordering by floppy disk

We will produce masks based on the mask files generated by the mask file generating utility. We shall assume the responsibility for errors only if the mask ROM data on the products we produce differs from this mask file. Thus, extreme care must be taken to verify the mask file in the submitted floppy disk.

The mask files forms hex-file made by the character font preparation program in the mask file generation utility. Submit the mask file after be saved in the floppy disk.

The submitted floppy disk must be 3.5-inch 2HD type and DOS/V format. And the number of the mask files must be one in one floppy disk.

File code

--	--	--	--	--	--	--	--

 (hexadecimal notation)

Mask file name

--	--	--	--	--	--	--	--

 .MSK (equal or less than eight characters)

* 2. Select the marking type (Check in the appropriate box).

- Special Mark Fill in the Mark Specification Form (20P2Q-A) and attach to the Mask ROM Confirmation Form.
- Standard Mark No writing is required.

* 3. Select the package type (Check in the appropriate box).

- SSOP (M35049-XXXFP)

* 4. Comments

SCREEN CHARACTER and PATTERN DISPLAY CONTROLLERS

GZZ-SH54-38B<8XA0>

Mask ROM number	
-----------------	--

※ 5.(Page 0) Test patterns

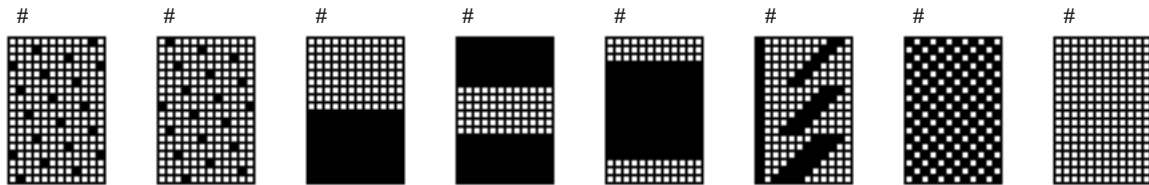

※ 6.(Page 0) Character patterns
(See the next page)

SCREEN CHARACTER and PATTERN DISPLAY CONTROLLERS

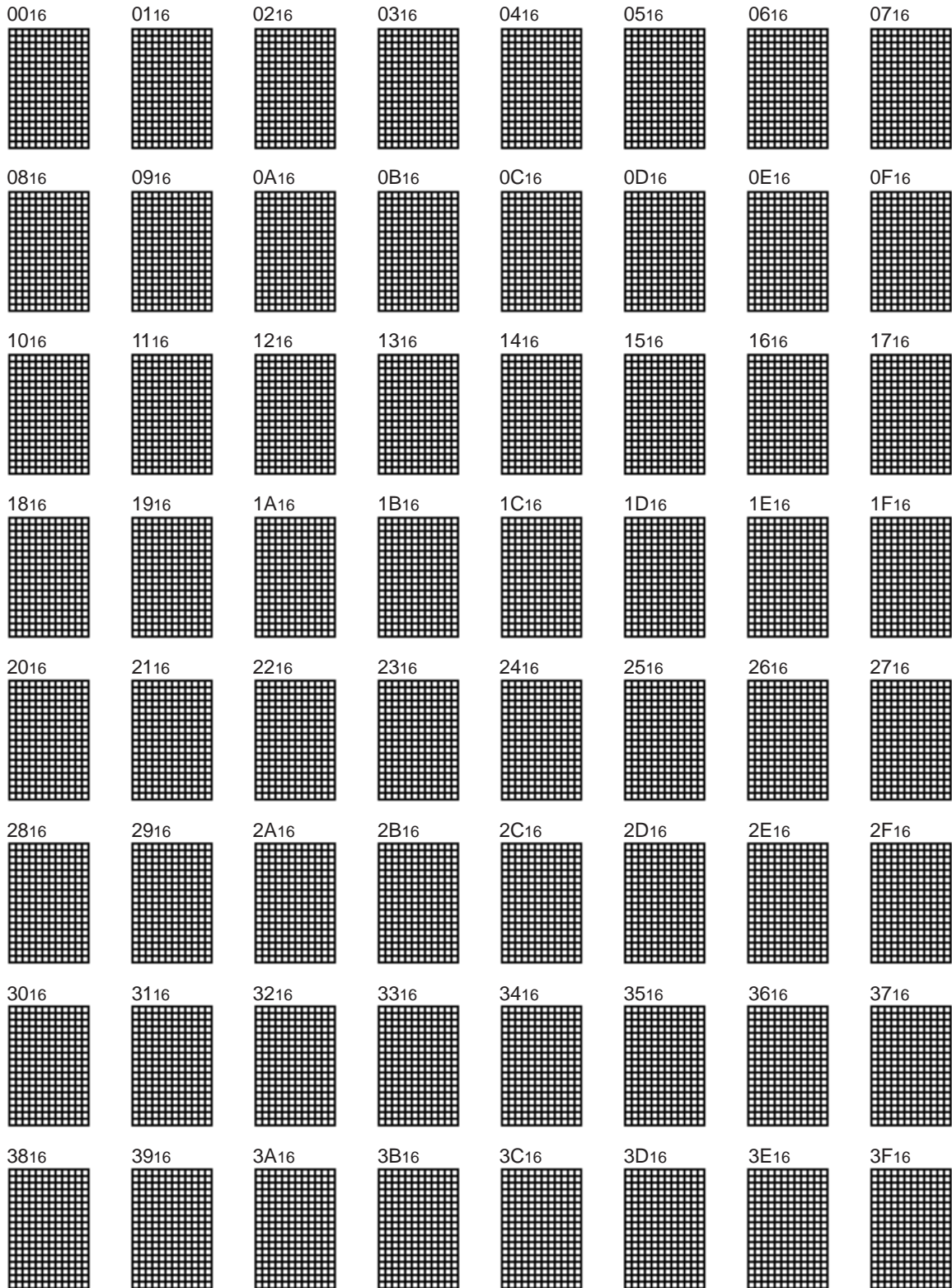

SCREEN CHARACTER and PATTERN DISPLAY CONTROLLERS

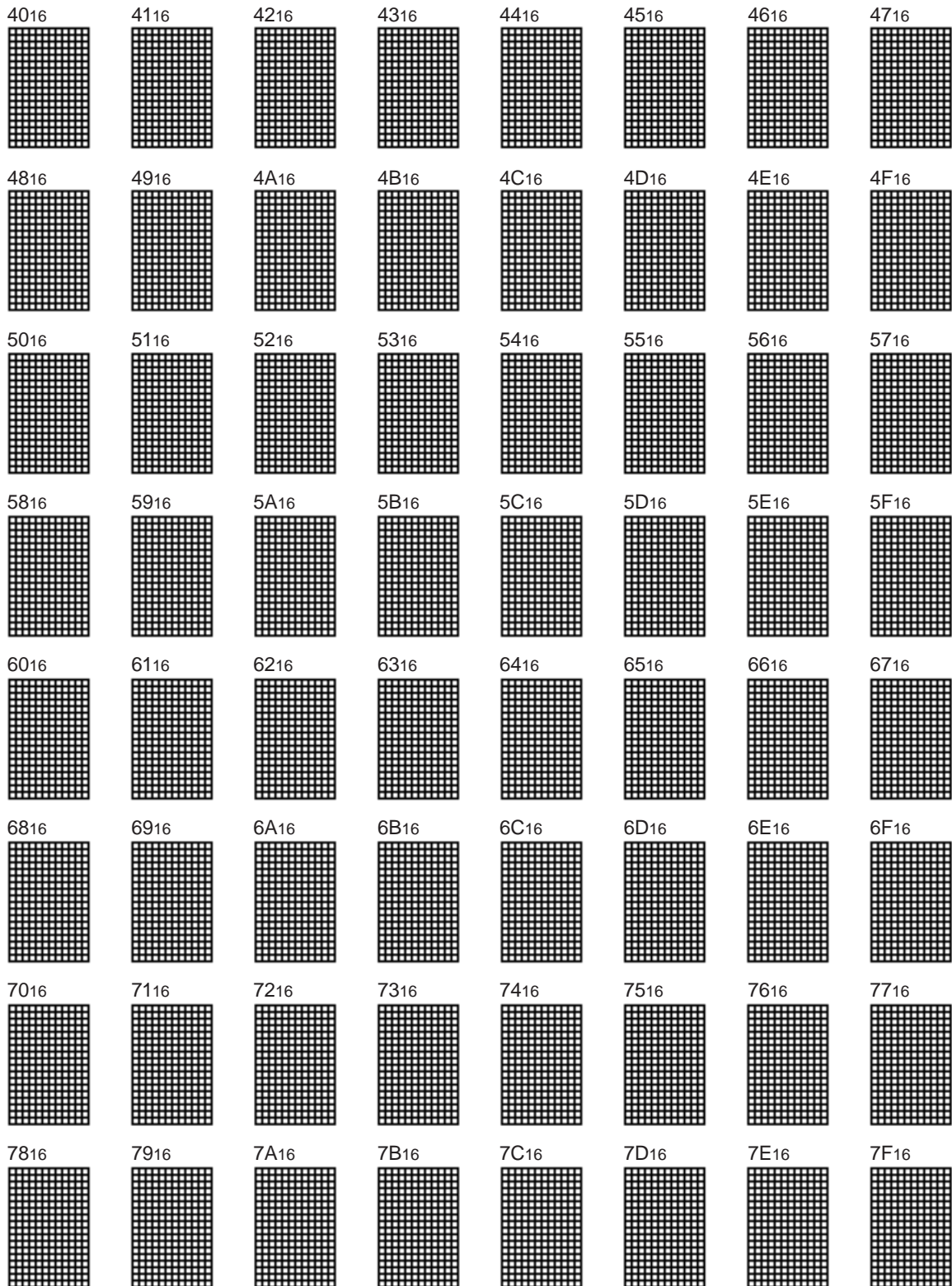

SCREEN CHARACTER and PATTERN DISPLAY CONTROLLERS

8016	8116	8216	8316	8416	8516	8616	8716
8816	8916	8A16	8B16	8C16	8D16	8E16	8F16
9016	9116	9216	9316	9416	9516	9616	9716
9816	9916	9A16	9B16	9C16	9D16	9E16	9F16
A016	A116	A216	A316	A416	A516	A616	A716
A816	A916	AA16	AB16	AC16	AD16	AE16	AF16
B016	B116	B216	B316	B416	B516	B616	B716
B816	B916	BA16	BB16	BC16	BD16	BE16	BF16

SCREEN CHARACTER and PATTERN DISPLAY CONTROLLERS

C016	C116	C216	C316	C416	C516	C616	C716
C816	C916	CA16	CB16	CC16	CD16	CE16	CF16
D016	D116	D216	D316	D416	D516	D616	D716
D816	D916	DA16	DB16	DC16	DD16	DE16	DF16
E016	E116	E216	E316	E416	E516	E616	E716
E816	E916	EA16	EB16	EC16	ED16	EE16	EF16
F016	F116	F216	F316	F416	F516	F616	F716
F816	F916	FA16	FB16	FC16	FD16	FE16	FF16 blank

※ 7.(Page 1) Test patterns

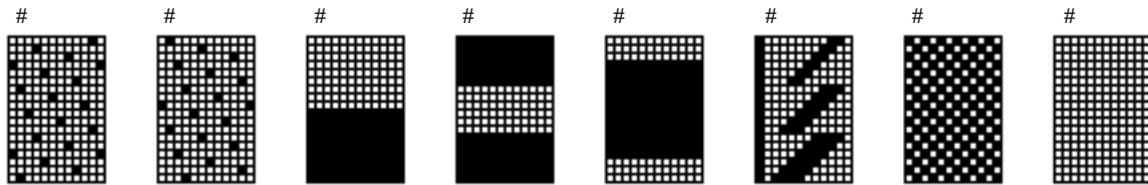

※ 8.(Page 1) Character patterns
(See the next page)

SCREEN CHARACTER and PATTERN DISPLAY CONTROLLERS

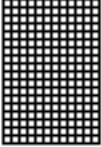
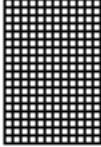
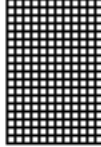
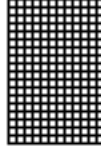
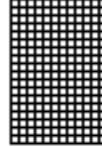
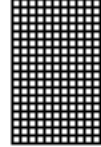
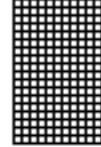
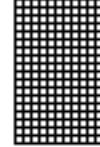
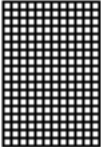
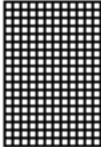
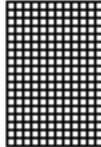
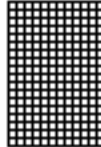
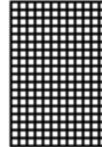
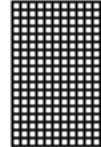
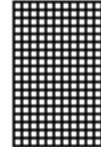
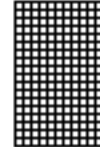
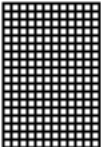
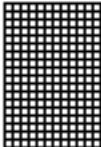
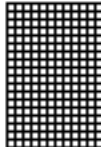
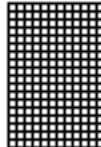
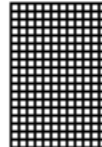
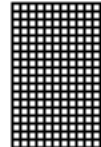
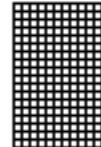
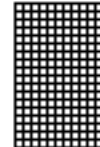
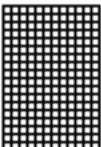
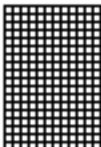
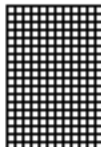
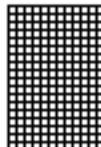
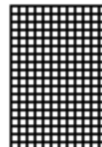
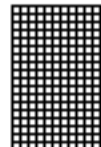
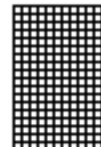
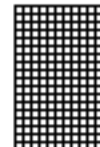
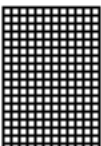
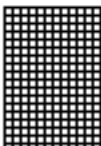
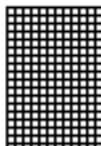
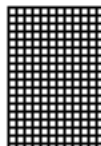
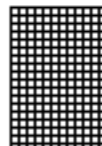
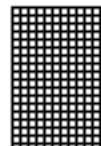
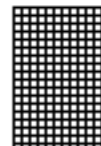
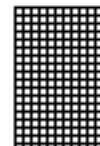
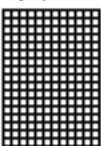
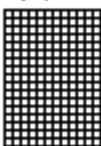
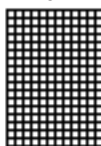
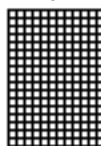
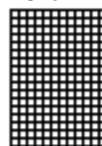
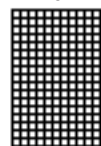
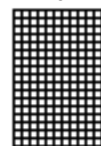
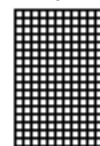
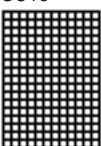
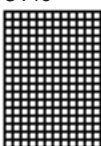
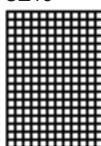
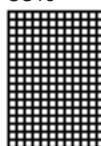
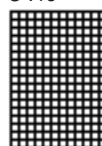
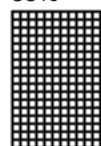
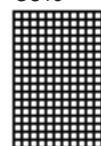
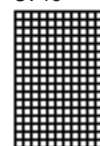
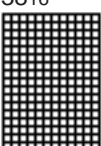
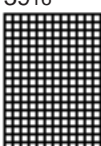
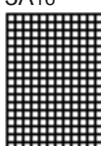
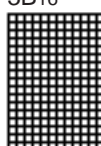
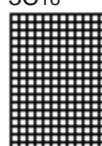
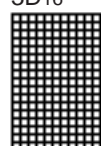
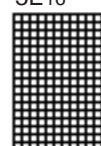
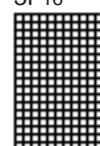
00 ₁₆ 	01 ₁₆ 	02 ₁₆ 	03 ₁₆ 	04 ₁₆ 	05 ₁₆ 	06 ₁₆ 	07 ₁₆ 
08 ₁₆ 	09 ₁₆ 	0A ₁₆ 	0B ₁₆ 	0C ₁₆ 	0D ₁₆ 	0E ₁₆ 	0F ₁₆ 
10 ₁₆ 	11 ₁₆ 	12 ₁₆ 	13 ₁₆ 	14 ₁₆ 	15 ₁₆ 	16 ₁₆ 	17 ₁₆ 
18 ₁₆ 	19 ₁₆ 	1A ₁₆ 	1B ₁₆ 	1C ₁₆ 	1D ₁₆ 	1E ₁₆ 	1F ₁₆ 
20 ₁₆ 	21 ₁₆ 	22 ₁₆ 	23 ₁₆ 	24 ₁₆ 	25 ₁₆ 	26 ₁₆ 	27 ₁₆ 
28 ₁₆ 	29 ₁₆ 	2A ₁₆ 	2B ₁₆ 	2C ₁₆ 	2D ₁₆ 	2E ₁₆ 	2F ₁₆ 
30 ₁₆ 	31 ₁₆ 	32 ₁₆ 	33 ₁₆ 	34 ₁₆ 	35 ₁₆ 	36 ₁₆ 	37 ₁₆ 
38 ₁₆ 	39 ₁₆ 	3A ₁₆ 	3B ₁₆ 	3C ₁₆ 	3D ₁₆ 	3E ₁₆ 	3F ₁₆ 

SCREEN CHARACTER and PATTERN DISPLAY CONTROLLERS

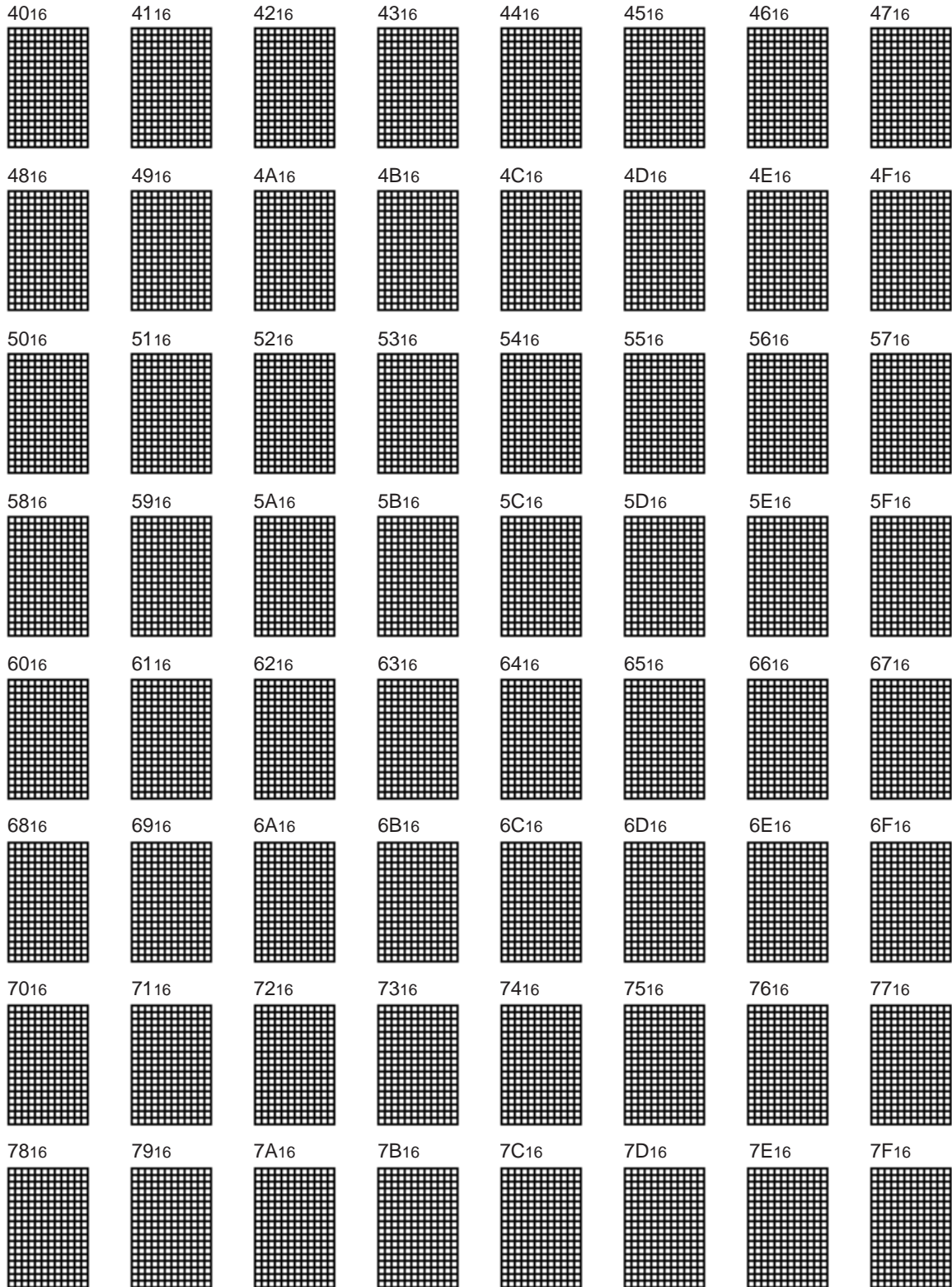

SCREEN CHARACTER and PATTERN DISPLAY CONTROLLERS

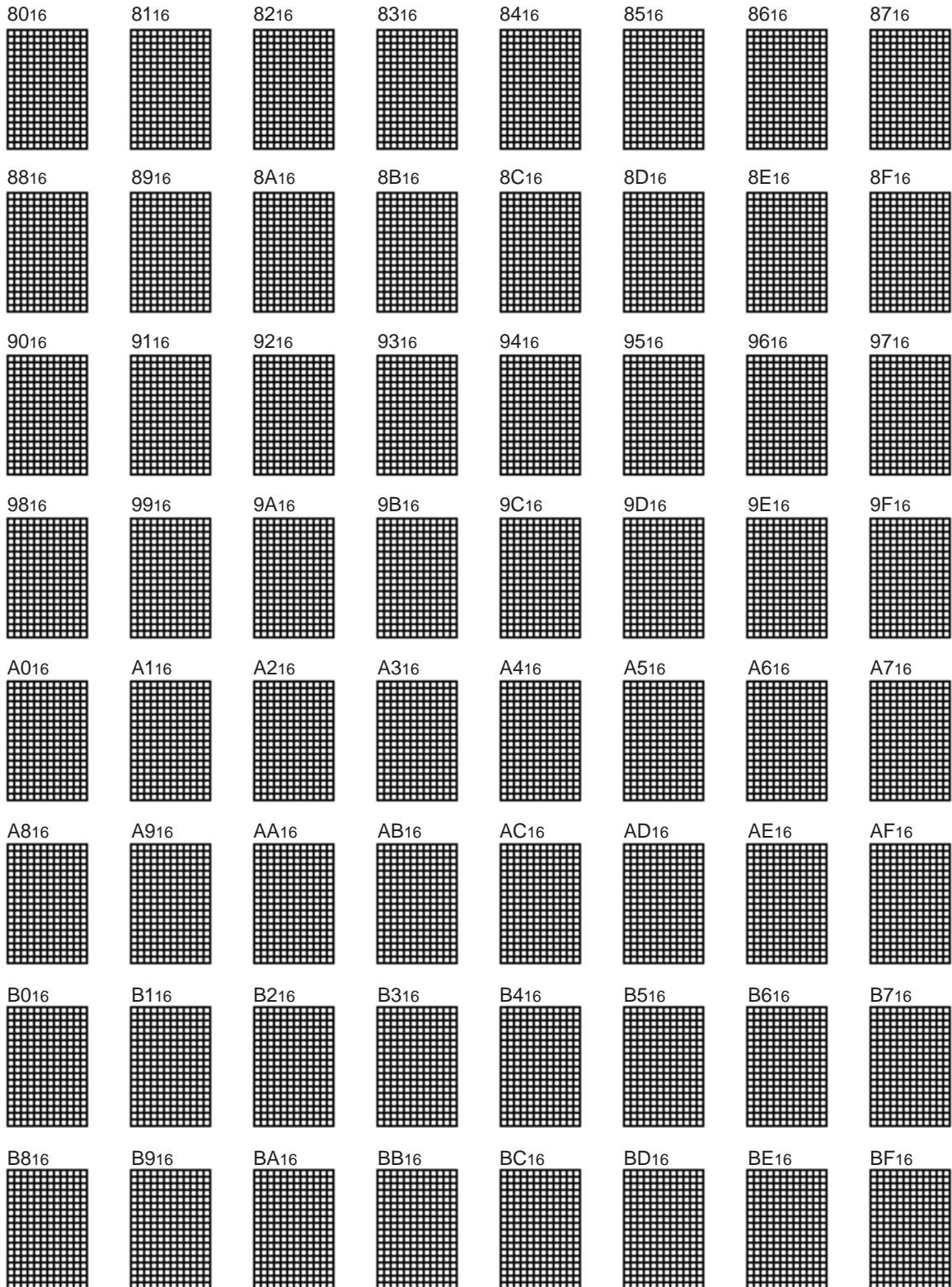

SCREEN CHARACTER and PATTERN DISPLAY CONTROLLERS

C016	C116	C216	C316	C416	C516	C616	C716
C816	C916	CA16	CB16	CC16	CD16	CE16	CF16
D016	D116	D216	D316	D416	D516	D616	D716
D816	D916	DA16	DB16	DC16	DD16	DE16	DF16
E016	E116	E216	E316	E416	E516	E616	E716
E816	E916	EA16	EB16	EC16	ED16	EE16	EF16
F016	F116	F216	F316	F416	F516	F616	F716
F816	F916	FA16	FB16	FC16	FD16	FE16	FF16 blank

20P2Q-A (20-PIN SSOP) MARK SPECIFICATION FORM

Mitsubishi IC catalog name

Please choose one of the marking types below (A, B, C), and enter the Mitsubishi IC catalog name and the special mark (if needed).

A. Standard Mitsubishi Mark

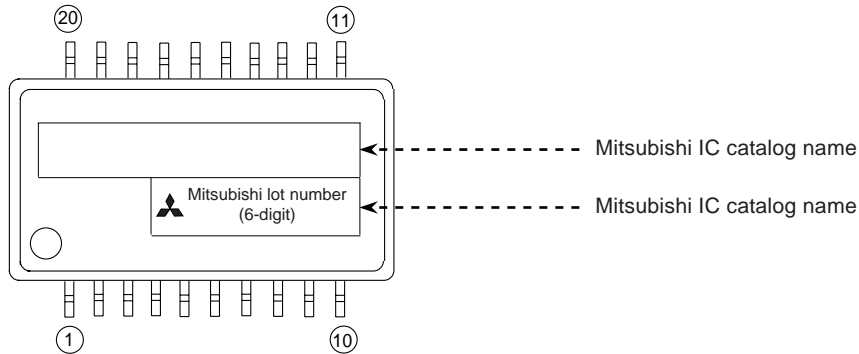

B. Customer's Parts Number + Mitsubishi IC Catalog Name

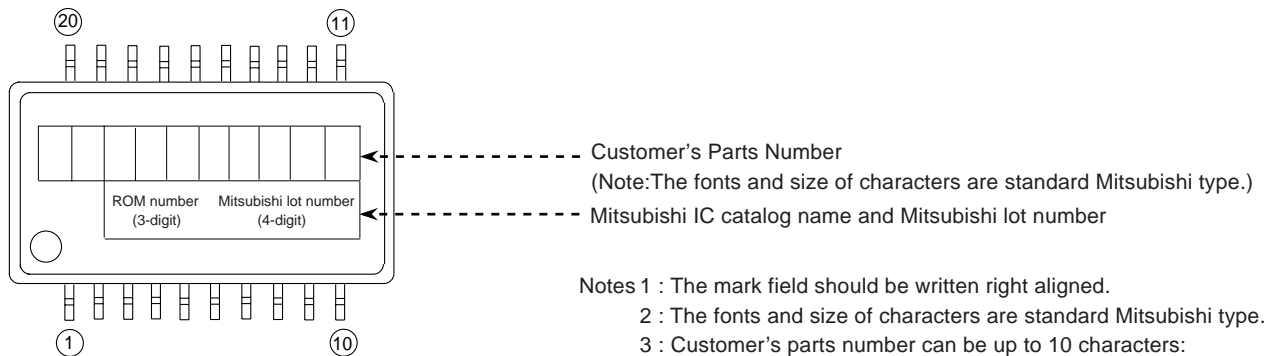

- Notes 1 : The mark field should be written right aligned.
 2 : The fonts and size of characters are standard Mitsubishi type.
 3 : Customer's parts number can be up to 10 characters:
 Only 0 to 9, A to Z, +, -, /, (,), &, ©, . (period),
 and , (comma) are usable.

C. Special Mark Required

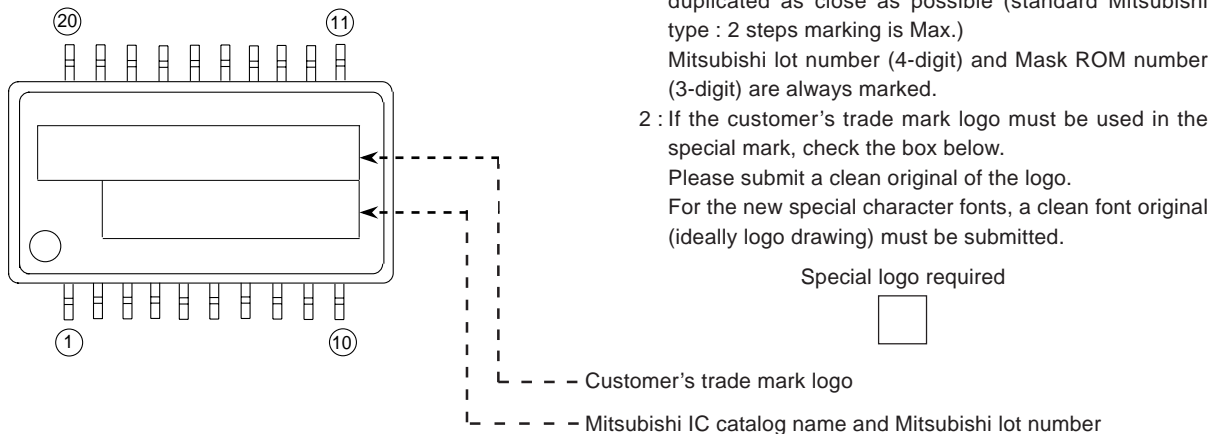

- Note 1 : If the special mark is to be printed, indicate the desired layout of the mark in the left figure. The layout will be duplicated as close as possible (standard Mitsubishi type : 2 steps marking is Max.)
 Mitsubishi lot number (4-digit) and Mask ROM number (3-digit) are always marked.
 2 : If the customer's trade mark logo must be used in the special mark, check the box below.
 Please submit a clean original of the logo.
 For the new special character fonts, a clean font original (ideally logo drawing) must be submitted.

Special logo required

The standard Mitsubishi font is used for all characters except for a logo.

20P2Q-A

Plastic 20pin 300mil SSOP

EIAJ Package Code	JEDEC Code	Weight (g)	Lead Material
SSOP020-P-0300	-	0.2	Cu Alloy

Scale : 4/1

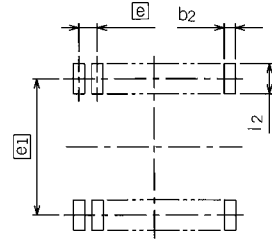
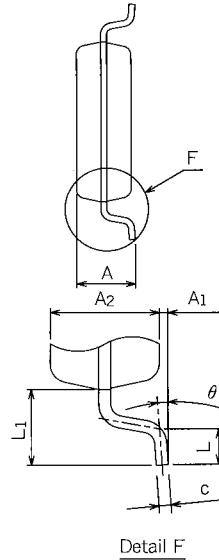
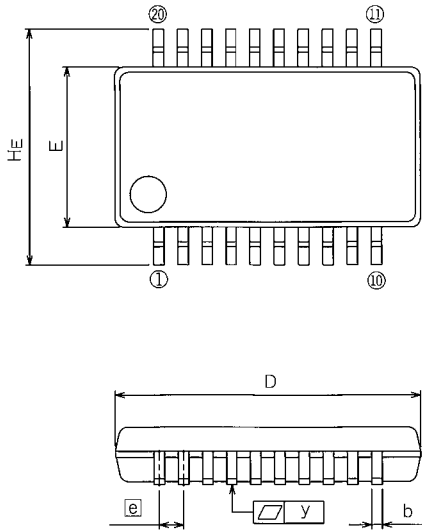

Recommended Mount Pad

Symbol	Dimension in Millimeters		
	Min	Nom	Max
A	-	-	2.1
A1	0	0.1	0.2
A2	-	1.8	-
b	0.3	0.35	0.45
c	0.18	0.2	0.25
D	10.0	10.1	10.2
E	5.2	5.3	5.4
e	-	0.8	-
HE	7.5	7.8	8.1
L	0.4	0.6	0.8
L1	-	1.25	-
y	-	-	0.1
theta	0°	-	8°
b2	-	0.5	-
e1	-	7.62	-
l2	1.27	-	-



Keep safety first in your circuit designs!

- Mitsubishi Electric Corporation puts the maximum effort into making semiconductor products better and more reliable, but there is always the possibility that trouble may occur with them. Trouble with semiconductors may lead to personal injury, fire or property damage. Remember to give due consideration to safety when making your circuit designs, with appropriate measures such as (i) placement of substitutive, auxiliary circuits, (ii) use of non-flammable material or (iii) prevention against any malfunction or mishap.

Notes regarding these materials

- These materials are intended as a reference to assist our customers in the selection of the Mitsubishi semiconductor product best suited to the customer's application; they do not convey any license under any intellectual property rights, or any other rights, belonging to Mitsubishi Electric Corporation or a third party.
- Mitsubishi Electric Corporation assumes no responsibility for any damage, or infringement of any third-party's rights, originating in the use of any product data, diagrams, charts, programs, algorithms, or circuit application examples contained in these materials.
- All information contained in these materials, including product data, diagrams, charts, programs and algorithms represents information on products at the time of publication of these materials, and are subject to change by Mitsubishi Electric Corporation without notice due to product improvements or other reasons. It is therefore recommended that customers contact Mitsubishi Electric Corporation or an authorized Mitsubishi Semiconductor product distributor for the latest product information before purchasing a product listed herein.
- The information described here may contain technical inaccuracies or typographical errors. Mitsubishi Electric Corporation assumes no responsibility for any damage, liability, or other loss rising from these inaccuracies or errors. Please also pay attention to information published by Mitsubishi Electric Corporation by various means, including the Mitsubishi Semiconductor home page (<http://www.mitsubishichips.com>).
- When using any or all of the information contained in these materials, including product data, diagrams, charts, programs, and algorithms, please be sure to evaluate all information as a total system before making a final decision on the applicability of the information and products. Mitsubishi Electric Corporation assumes no responsibility for any damage, liability or other loss resulting from the information contained herein.
- Mitsubishi Electric Corporation semiconductors are not designed or manufactured for use in a device or system that is used under circumstances in which human life is potentially at stake. Please contact Mitsubishi Electric Corporation or an authorized Mitsubishi Semiconductor product distributor when considering the use of a product contained herein for any specific purposes, such as apparatus or systems for transportation, vehicular, medical, aerospace, nuclear, or undersea repeater use.
- The prior written approval of Mitsubishi Electric Corporation is necessary to reprint or reproduce in whole or in part these materials.
- If these products or technologies are subject to the Japanese export control restrictions, they must be exported under a license from the Japanese government and cannot be imported into a country other than the approved destination.
- Any diversion or reexport contrary to the export control laws and regulations of Japan and/or the country of destination is prohibited.
- Please contact Mitsubishi Electric Corporation or an authorized Mitsubishi Semiconductor product distributor for further details on these materials or the products contained therein.