

## PNP Silicon AF Transistors

**BC 327**  
**BC 328**

- High current gain
- High collector current
- Low collector-emitter saturation voltage
- Complementary types: BC 337, BC 338 (NPN)

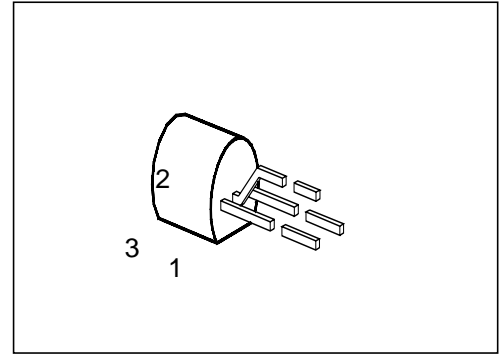

Type	Marking	Ordering Code	Pin Configuration			Package <sup>1)</sup>
			1	2	3	
BC 327	—	Q62702-C311	C	B	E	TO-92
BC 327-16		Q62702-C311-V3				
BC 327-25		Q62702-C311-V4				
BC 327-40		Q62702-C311-V2				
BC 328		Q62702-C312				
BC 328-16		Q62702-C312-V3				
BC 328-25		Q62702-C312-V4				
BC 328-40		Q62702-C312-V2				

<sup>1)</sup> For detailed information see chapter Package Outlines.

## Maximum Ratings

Parameter	Symbol	Values		Unit
		BC 327	BC 328	
Collector-emitter voltage	$V_{CE0}$	45	25	V
Collector-base voltage	$V_{CB0}$	50	30	
Emitter-base voltage	$V_{EB0}$	5		
Collector current	$I_C$	800		mA
Peak collector current	$I_{CM}$	1		A
Base current	$I_B$	100		mA
Peak base current	$I_{BM}$	200		
Total power dissipation, $T_C = 66\text{ °C}$	$P_{tot}$	625		mW
Junction temperature	$T_j$	150		°C
Storage temperature range	$T_{stg}$	- 65 ... + 150		

## Thermal Resistance

Junction - ambient	$R_{th\ JA}$	≤ 200	K/W
Junction - case <sup>1)</sup>	$R_{th\ JC}$	≤ 135	

<sup>1)</sup> Mounted on Al heat sink 15 mm × 25 mm × 0.5 mm.

## Electrical Characteristics

at  $T_A = 25\text{ °C}$ , unless otherwise specified.

Parameter	Symbol	Values			Unit
		min.	typ.	max.	

### DC characteristics

Collector-emitter breakdown voltage $I_C = 10\text{ mA}$	$V_{(BR)CE0}$				V
BC 327		45	–	–	
BC 328		25	–	–	
Collector-base breakdown voltage $I_C = 100\text{ }\mu\text{A}$	$V_{(BR)CB0}$				
BC 327		50	–	–	
BC 328		30	–	–	
Emitter-base breakdown voltage $I_E = 10\text{ }\mu\text{A}$	$V_{(BR)EB0}$	5	–	–	
Collector cutoff current $V_{CB} = 25\text{ V}$	$I_{CB0}$				nA
BC 328		–	–	100	
$V_{CB} = 45\text{ V}$					nA
BC 327		–	–	100	
$V_{CB} = 25\text{ V}, T_A = 150\text{ °C}$					$\mu\text{A}$
BC 328		–	–	10	
$V_{CB} = 45\text{ V}, T_A = 150\text{ °C}$					$\mu\text{A}$
BC 327		–	–	10	
Emitter cutoff current $V_{EB} = 4\text{ V}$	$I_{EB0}$	–	–	100	nA
DC current gain <sup>1)</sup> $I_C = 100\text{ mA}; V_{CE} = 1\text{ V}$	$h_{FE}$				–
BC 327/16; BC 328/16		100	160	250	
BC 327/25; BC 328/25		160	250	400	
BC 327/40; BC 328/40		250	350	630	
$I_C = 300\text{ mA}; V_{CE} = 1\text{ V}$					
BC 327/16; BC 328/16		60	–	–	
BC 327/25; BC 328/25		100	–	–	
BC 327/40; BC 328/40		170	–	–	
Collector-emitter saturation voltage <sup>1)</sup> $I_C = 500\text{ mA}; I_B = 50\text{ mA}$	$V_{CEsat}$	–	–	0.7	V
Base-emitter saturation voltage <sup>1)</sup> $I_C = 500\text{ mA}; I_B = 50\text{ mA}$	$V_{BEsat}$	–	–	2	

<sup>1)</sup> Pulse test:  $t \leq 300\text{ }\mu\text{s}, D \leq 2\text{ %}$ .

## Electrical Characteristics

at  $T_A = 25\text{ }^\circ\text{C}$ , unless otherwise specified.

Parameter	Symbol	Values			Unit
		min.	typ.	max.	

### AC characteristics

Transition frequency $I_C = 50\text{ mA}$ , $V_{CE} = 5\text{ V}$ , $f = 20\text{ MHz}$	$f_t$	–	200	–	MHz
Output capacitance $V_{CB} = 10\text{ V}$ , $f = 1\text{ MHz}$	$C_{obo}$	–	12	–	pF
Input capacitance $V_{EB} = 0.5\text{ V}$ , $f = 1\text{ MHz}$	$C_{ibo}$	–	60	–	

**Total power dissipation**  $P_{tot} = f(T_A; T_C)$

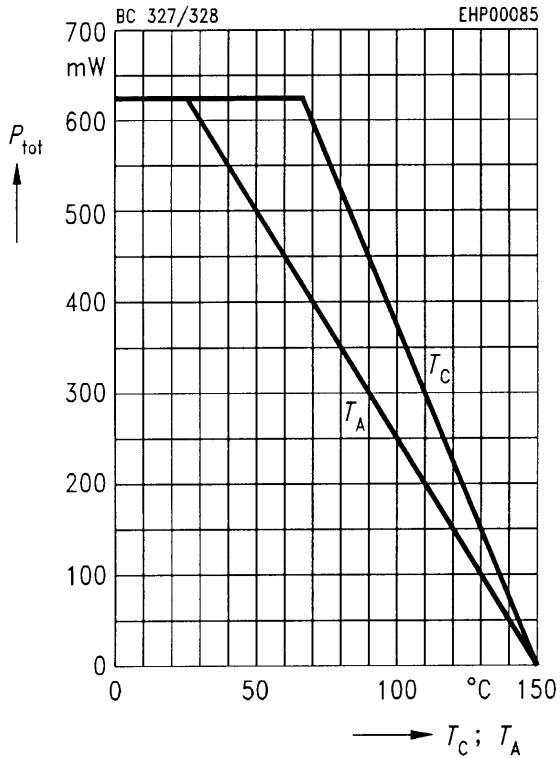

**Permissible pulse load**  $R_{thJA} = f(t_p)$

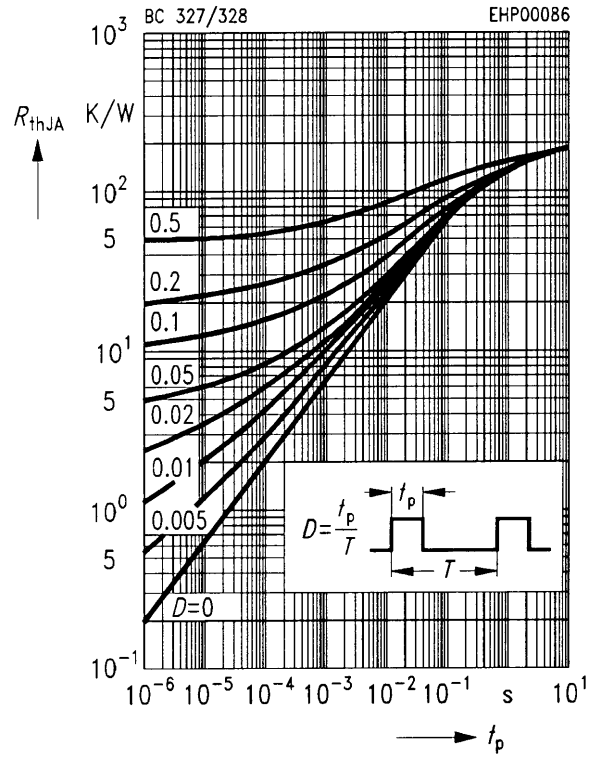

**Collector current**  $I_C = f(V_{BE})$   
 $V_{CE} = 1$  V

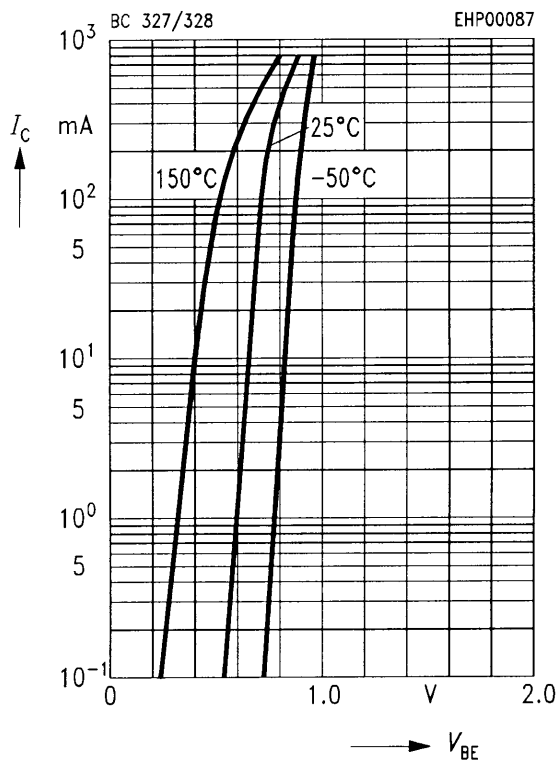

**Collector cutoff current**  $I_{CB0} = f(T_A)$   
 $V_{CB} = 45$  V

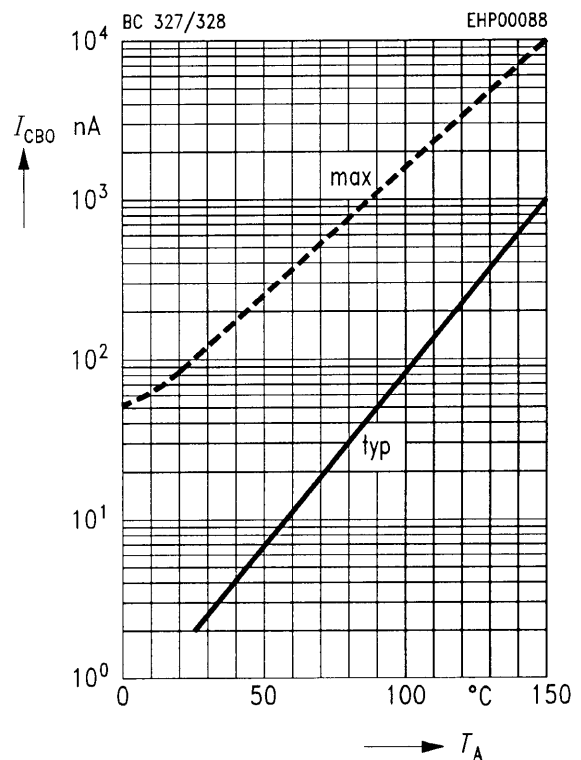

**DC current gain  $h_{FE} = f(I_C)$**

$V_{CE} = 1\text{ V}$

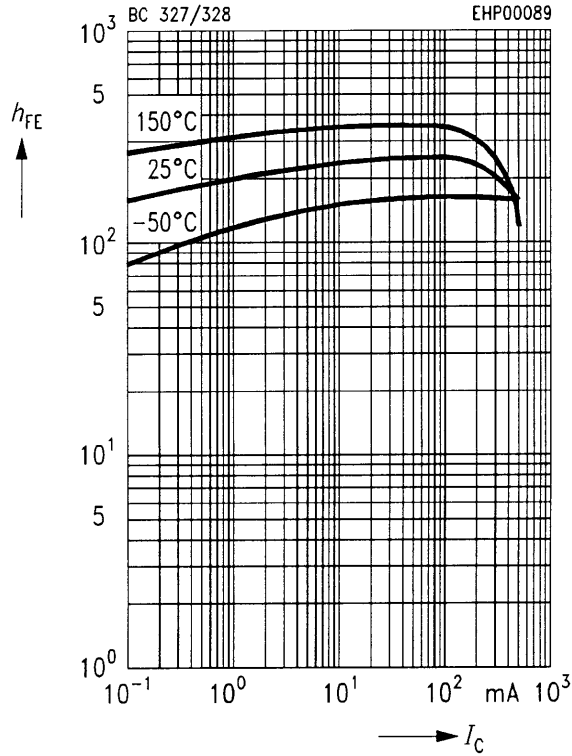

**Transition frequency  $f_T = f(I_C)$**

$f = 20\text{ MHz}, T_A = 25^\circ\text{C}$

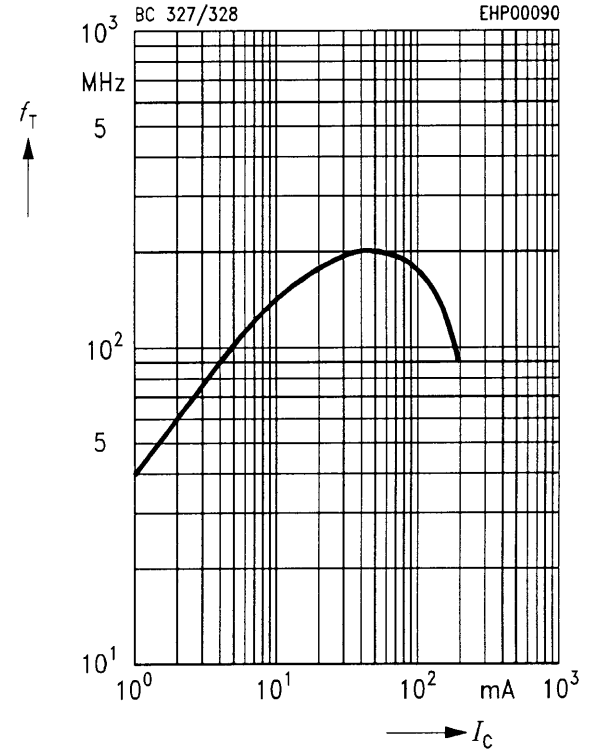

**Collector-emitter saturation voltage**

$V_{CEsat} = f(I_C)$

$h_{FE} = 10$

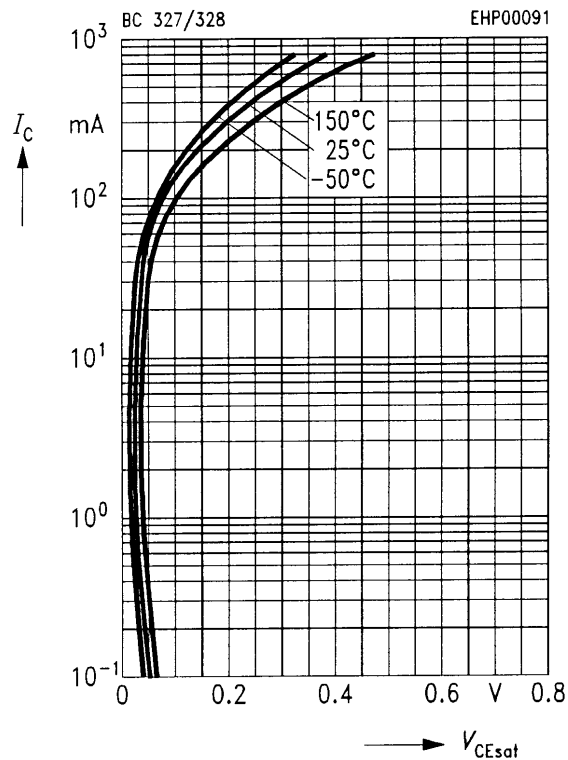

**Base-emitter saturation voltage**

$V_{BEsat} = f(I_C)$

$h_{FE} = 10$

