



MAX1533 Evaluation Kit

General Description

The MAX1533 evaluation kit (EV kit) demonstrates the MAX1533's standard application circuit. This dual-PWM synchronous DC-DC converter steps down high-voltage batteries and/or AC adapters, generating main supplies for notebook computers. The MAX1533 EV kit operates at 300kHz switching frequency and provides dual 5V and 3.3V output voltages from a 5V to 24V battery input range. It delivers up to 5A output current for the 5V output and 6A for the 3.3V output with 97% efficiency. Both outputs are adjustable between 1V and 5.5V by changing feedback resistors R19–R22.

The MAX1533 also has an internal fixed 3.3V and 5V linear regulator capable of supplying 100mA. The MAX1533 EV kit operates at 300kHz switching frequency.

Features

- ◆ 6V to 24V Input Range
- ◆ Internal 5V and 3.3V Linear Regulators with 100mA Load Capability
- ◆ Output Voltage:
 - 3.3V at 5A (Adjustable from 1V to 5.5V)
 - 5V at 5A (Adjustable from 1V to 5.5V)
- ◆ 300kHz Switching Frequency (Selectable 200kHz/300kHz/500kHz)
- ◆ Power-Good Output
- ◆ Selectable Over- and Undervoltage Protection
- ◆ 32-Pin Thin QFN Package
- ◆ Fully Assembled and Tested

Ordering Information

PART	TEMP RANGE	IC PACKAGE
MAX1533EVKIT	0°C to +70°C	32 Thin QFN

Component List

DESIGNATION	QTY	DESCRIPTION
C1	0	Not installed, capacitor (1812)
C2, C3	2	10 μ F \pm 10%, 25V X7R ceramic capacitors (1812) TDK C4532X7R1E106K
C4, C6	0	Not installed, D-size capacitors
C5	1	150 μ F \pm 20%, 6.3V, 25m Ω POSCAP/KO-CAP Kemet T520D157M006ASE025 Sanyo 6TPE150M
C7	1	220 μ F \pm 20%, 6.3V, 25m Ω POSCAP/KO-CAP Kemet T520V227M006ASE025 Sanyo 6TPE220M
C9, C11, C18	3	1 μ F \pm 10%, 10V, X5R ceramic capacitors (0603) Murata GRM188R61A105K TDK C1608X5R1A105K
C10, C14, C17	3	0.1 μ F \pm 10%, 25V X7R ceramic capacitors (0603) Murata GRM188R71E104K TDK C1608X7R1E104K
C12	1	0.22 μ F \pm 10%, 16V X7R ceramic capacitor (0603) Murata GRM188R71E224K TDK C1608X7R1C224K

DESIGNATION	QTY	DESCRIPTION
C13	1	0.022 μ F \pm 10%, 50V X7R ceramic capacitor (0603) Murata GRM188R71H223K TDK C1608X7R1H223K
C15, C19	2	10 μ F \pm 20%, 6.3V X5R ceramic capacitors (0805) Murata GRM21BR60J106M TDK C2012X5R0J106M
C16	0	Not installed, capacitor (0805)
C23	1	4.7 μ F \pm 10%, 25V X7R ceramic capacitor (1210) TDK C3225X7R1E475K
C24, C25	0	Not installed, capacitors (0603)
D1, D2	2	2A, 30V, SMA Schottky diodes Central Semiconductor CMSH2-40M Diodes Inc. B230A
D3	1	100mA, 30V, dual Schottky diode, common anode, SOT23 Central Semiconductor CMPSH-3A
JU1–JU6	6	3-pin headers, 0.1in center
JU8	1	6-pin header, 2x3, 0.1in center
JU9, JU10, JU12, JU14	0	Not installed, 2-pin jumpers (0603)



MAX1533 Evaluation Kit

Component List (continued)

DESIGNATION	QTY	DESCRIPTION
L1, L2	2	5.8 μ H, 8.6A, 16.2m Ω inductors Sumida CDRH127/LD-5R8NC
N1, N3	2	8.4A, 30V n-channel MOSFETs, SO-8 Fairchild FDS6612A
N2, N4	2	13A, 30V n-channel MOSFETs, SO-8 Fairchild FDS6670A
R1, R2	2	0.01 Ω \pm 1%, 0.5W sense resistor (2010) IRC LRC-LRF2010-01-R010-F Vishay Dale WSL2010 0.010 1.0%
R3	1	20 Ω \pm 5% resistor (0603)
R4–R12, R16, R19–R24	0	Not installed, resistors (0603)
R14	1	100k Ω \pm 5% resistor (0603)
R15	0	Not installed, resistor (1206)
U1	1	MAX1533ETJ, 32-pin thin QFN (5mm x 5mm)
None	1	MAX1533 EV Kit PC board
None	7	Shunts

Quick Start

Recommended Equipment

Before beginning, the following equipment is recommended:

- 6V to 24V, 100W, DC power supply
- Dummy loads capable of sinking 5A
- 3 voltmeters
- An oscilloscope

Procedure

The MAX1533 EV kit is a fully assembled and tested surface-mount board. Follow the steps below to verify board operation. **Do not turn on the power supply until all connections are completed.**

- 1) Verify that the shunts are in the following positions:
 - JU1 = 1-2 (overvoltage protection disabled)
 - JU2 = 1-2 (MAX1533 enabled)
 - JU3 = 1-2 (undervoltage protection disabled)
 - JU4 = 1-2 (PWM mode)
 - JU5 = 1-2 (5V main output enabled)
 - JU6 = 1-2 (3.3V main output enabled)
 - JU8 = 3-4 (300kHz operation)
- 2) Connect the power supply across the VIN and PGND pads.
- 3) Connect a voltmeter across the 5V_MAIN and PGND pads.
- 4) Connect a voltmeter across the 3.3V_MAIN and PGND pads.
- 5) Turn on the power supply.
- 6) Verify the output voltages.

Component Suppliers

SUPPLIER	PHONE	FAX	WEBSITE
Central Semiconductor	631-435-1110	631-435-1824	www.centralsemi.com
Diodes Incorporated	805-446-4800	805-446-4850	www.diodes.com
Fairchild Semiconductor	888-522-5372	—	www.fairchildsemi.com
IRC (International Resistive Company)	361-992-7900	361-992-3377	www.irctt.com
Kemet	864-963-6300	864-963-6322	www.kermit.com
Murata	770-436-1300	770-436-3030	www.murata.com
Sanyo	619-661-6835	619-661-1055	www.sanyodevice.com
Sumida	847-545-6700	847-545-6720	www.sumida.com
TDK	847-803-6100	847-390-4405	www.component.tdk.com
Vishay	402-564-3131	402-563-6296	www.vishay.com

Note: Indicate that you are using the MAX1533 when contacting these suppliers.

MAX1533 Evaluation Kit

Evaluates: MAX1533

Table 1. Jumper Selection

FUNCTION	JUMPER	JUMPER POSITION	DESCRIPTION
$\overline{\text{OVP}}$	JU1	1-2*	Disables overvoltage protection
		2-3	Enables overvoltage protection
$\overline{\text{SHDN}}$	JU2	1-2*	Enables the MAX1533
		2-3	Places the MAX1533 in shutdown
$\overline{\text{UVP}}$	JU3	1-2*	Disables undervoltage protection
		2-3	Enables undervoltage protection
$\overline{\text{SKIP}}$	JU4	1-2*	Places the MAX1533 in low-noise forced-PWM mode
		2-3	Places the MAX1533 in high-efficiency pulse-skipping mode at light loads
ON5	JU5	1-2*	Enables the 5V main output
		2-3	Disables the 5V main output
ON3	JU6	1-2*	Enables the 3.3V main output
		2-3	Disables the 3.3V main output

*Default position.

Detailed Description

3.3V_MAIN Output Voltage Setting

The MAX1533 EV kit is shipped with FB3 connected to GND, which sets the 3.3V_MAIN voltage to 3.3V.

To change the output voltage to a value between 1V and 5.5V, set R20 equal to $10\text{k}\Omega \pm 1\%$ and calculate R19 using the equation:

$$R19 = R20 [(V_{\text{OUT}}/V_{\text{FB3}}) - 1]$$

where $V_{\text{FB3}} = 1\text{V}$. For an output voltage of 1V, place a short across R19 and leave R20 open.

5V_MAIN Output Voltage Setting

The MAX1533 EV kit is shipped with the FB5 connected to GND, which sets the 5V_MAIN voltage to 5V.

To change the output voltage to a value between 1V and 5.5V, set R22 equal to $10\text{k}\Omega \pm 1\%$ and calculate R21 using the equation:

$$R21 = R22 [(V_{\text{OUT}} / V_{\text{FB5}}) - 1]$$

where $V_{\text{FB5}} = 1\text{V}$. For an output voltage of 1V, place a short across R21 and leave R22 open.

Frequency Selection

The MAX1533 operates at 200kHz/300kHz/500kHz switching frequency. The EV kit is shipped with the frequency set to 300kHz. Move the shunt on JU8 to select a different switching frequency (see Table 2).

Table 2. Frequency Selection

FREQUENCY (kHz)	FSEL (JU8)
200	GND (1-2)
300*	REF (3-4)
500	V _{CC} (5-6)

*Default position.

Note: Do not change the operating frequency without first recalculating component values because the frequency has a significant effect on preferred inductor value, peak current-limit level, MOSFET heating, PFM/PWM switchover point, output noise, efficiency, and other critical parameters.

MAX1533 Evaluation Kit

Evaluates: MAX1533

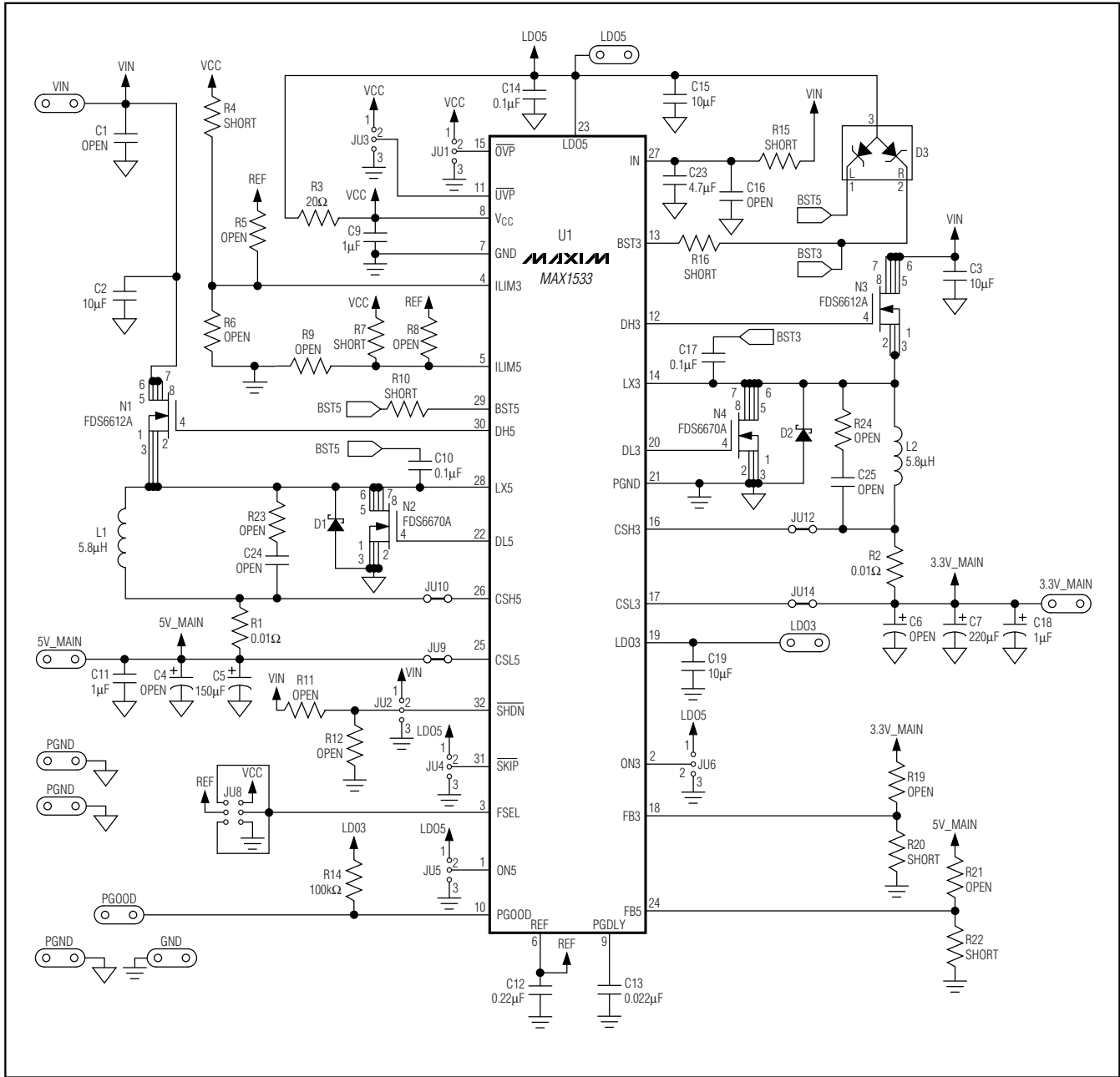

Figure 1. MAX1533 EV Kit Schematic

MAX1533 Evaluation Kit

Evaluates: MAX1533

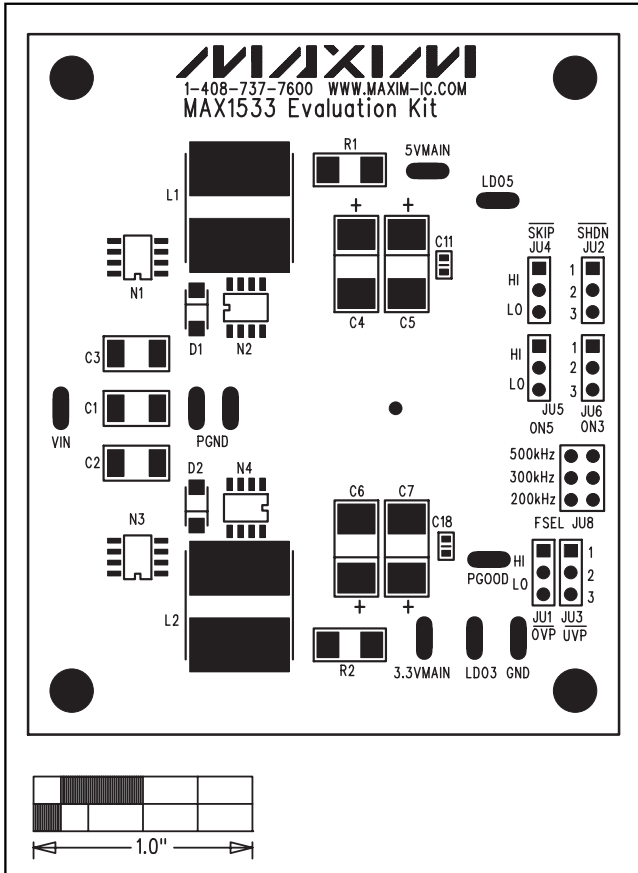

Figure 2. MAX1533 EV Kit Component Placement Guide—Component Side

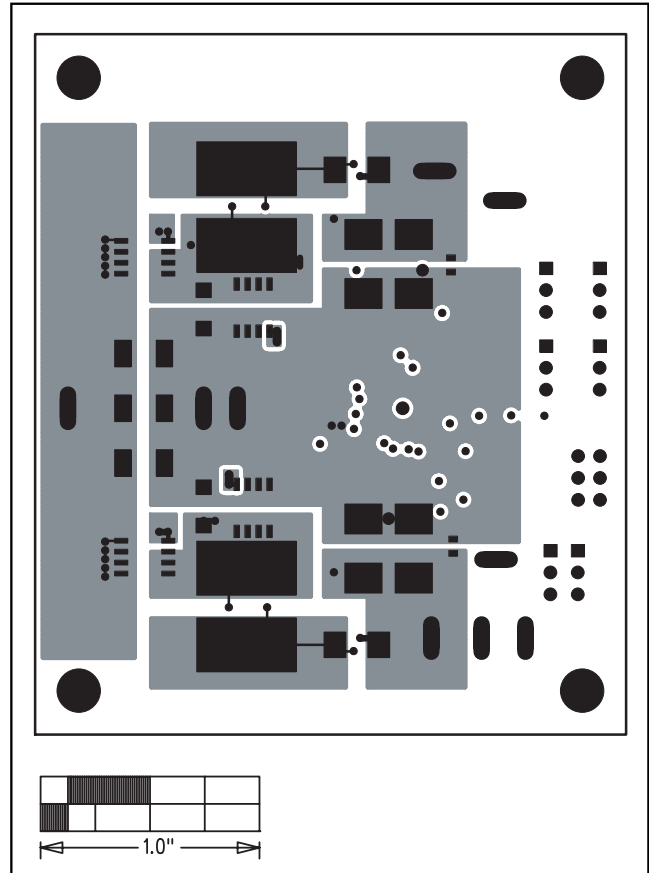

Figure 3. MAX1533 EV Kit PC Board Layout—Component Side

MAX1533 Evaluation Kit

Evaluates: MAX1533

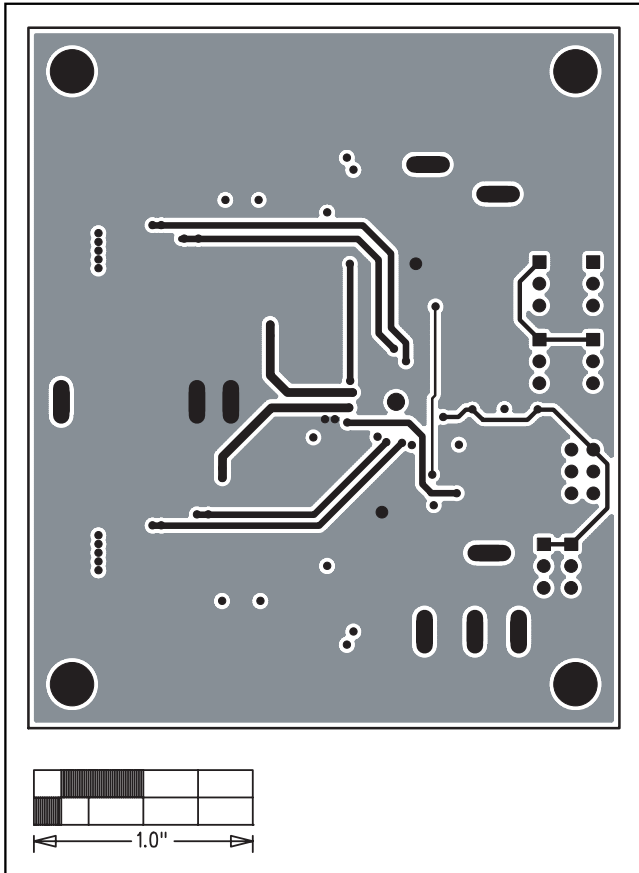

Figure 4. MAX1533 EV Kit PC Board Layout—Layer 2

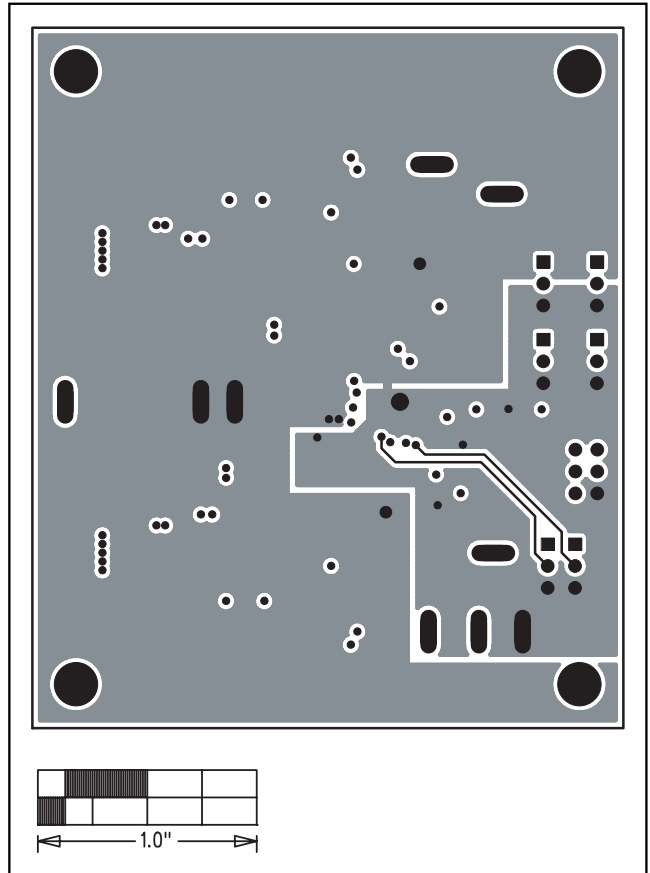

Figure 5. MAX1533 EV Kit PC Board Layout—Layer 3

MAX1533 Evaluation Kit

Evaluates: MAX1533

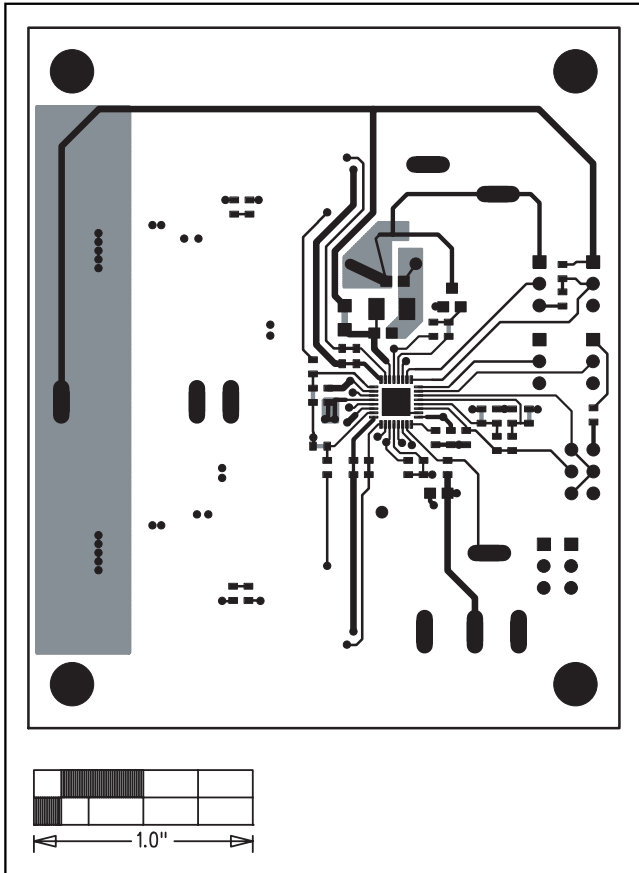

Figure 6. MAX1533 EV Kit PC Board Layout—Solder Side

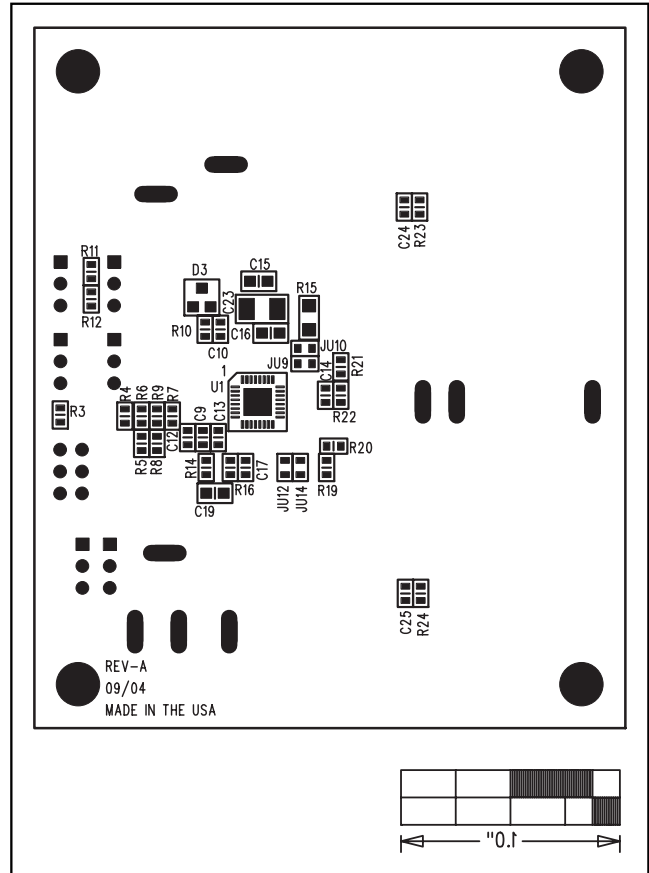

Figure 7. MAX1533 EV Kit Component Placement Guide—Solder Side

Maxim cannot assume responsibility for use of any circuitry other than circuitry entirely embodied in a Maxim product. No circuit patent licenses are implied. Maxim reserves the right to change the circuitry and specifications without notice at any time.

Maxim Integrated Products, 120 San Gabriel Drive, Sunnyvale, CA 94086 408-737-7600 _____ 7