

LOW POWER SUPER SMALL-SIZED SINGLE C-MOS COMPARATOR

■GENERAL DESCRIPTION

The **NJU7119** is super small-sized package single C-MOS comparator with open drain output.

The operating voltage is from 1.8V to 5.5V. The output can drive TTL, C-MOS and various voltage levels.

The input offset voltage is lower than 7mV and the package is super small-sized SC88A. The **NJU7119** is suitable for battery use items and other portable items.

■PACKAGE INFORMATION



NJU7119F3

■FEATURES

- Single Low Power Supply $V_{DD}=1.8\sim 5.5V$
- Low Offset Voltage $V_{IO}=7mV$ (max.)
- Low Operating Current $I_{DD}=100\mu A$ (typ.)
- Propagation Delay (t_{PLH}/t_{PHL}) 160/70ns (typ.)
- Output Signal Falling Time (t_{THL}) 4ns (typ.)
- Open Drain Output
- Package Outline SC88A
- C-MOS Technology

■PIN CONFIGURATION

(Top View)

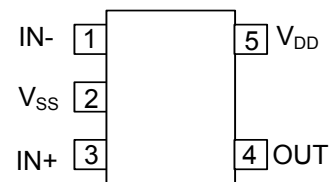

■EQUIVALENT CIRCUIT

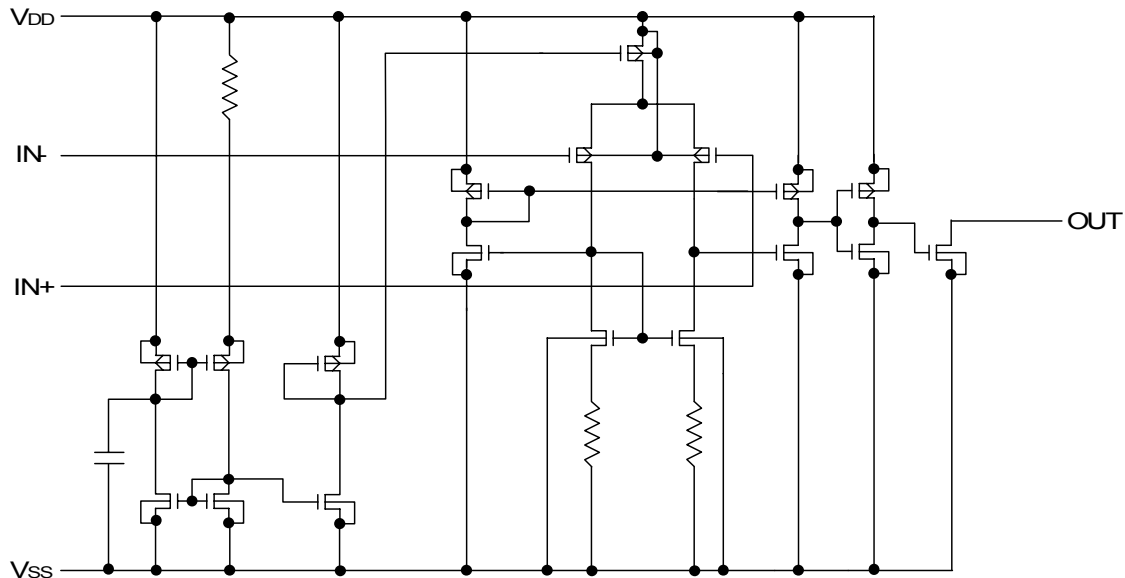

■ABSOLUTE MAXIMUM RATINGS

(Ta=25°C)

PARAMETER	SYMBOL	RATING	UNIT
Supply Voltage	V _{DD}	7.0	V
Differential Input Voltage	V _{ID}	±7.0 (Note1)	V
Common Mode Input Voltage	V _{IC}	-0.3~7.0	V
Power Dissipation	P _D	250 (Note3)	mW
Operating Temperature	T _{opr}	-40~+85	°C
Storage Temperature	T _{stg}	-55~+125	°C

Note1) If the supply voltage (V_{DD}) is less than 7.0V, the input voltage must not exceed the V_{DD} level though 7.0V is limit specified.

Note2) The output pull-up voltage must not over the V_{DD} level.

Note3) The power dissipation is value mounted on a glass epoxy board (FR-4) in size of 50x50x1.6 millimeters square.

Note4) Decoupling capacitor should be connected between V_{DD} and V_{SS} due to the stabilized operation for the circuit.

■RECOMMENDED OPERATING CONDITION

(Ta=25°C)

PARAMETER	SYMBOL	CONDITIONS	MIN	TYP	MAX	UNIT
Operating Voltage	V _{DD}		1.8	-	5.5	V

■ELECTRICAL CHARACTERISTICS

●DC CHARACTERISTICS

(V_{DD}=3.0V, R_L=∞, Ta=25°C)

PARAMETER	SYMBOL	CONDITIONS	MIN	TYP	MAX	UNIT
Input Offset Voltage	V _{IO}	V _{IN} =V _{DD} /2	-	-	7	mV
Input Offset Current	I _{IO}		-	1	-	pA
Input Bias Current	I _{IB}		-	1	-	pA
Input Common Mode Voltage Range	V _{ICM}		0~2.4	-	-	V
Low Level Output Voltage	V _{OL}	I _{OL} =+5mA	-	-	0.3	V
Operating Current	I _{DD}		-	100	200	μA

●TRANSIENT CHARACTERISTICS

(V_{DD}=3.0V, f=10kHz, C_L=15pF, Ta=25°C)

PARAMETER	SYMBOL	CONDITIONS	MIN	TYP	MAX	UNIT
Propagation Delay Low to High	t _{PLH}	Over Drive=100mV	-	160	-	ns
Propagation Delay High to Low	t _{PHL}	Over Drive=100mV	-	70	-	ns
Output Signal Falling Time	t _{THL}	Over Drive=100mV	-	4	-	ns

■ TERMINAL EQUIVALENT CIRCUIT

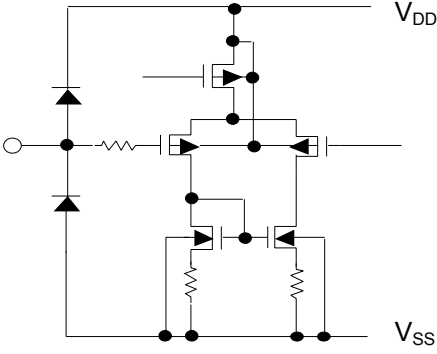
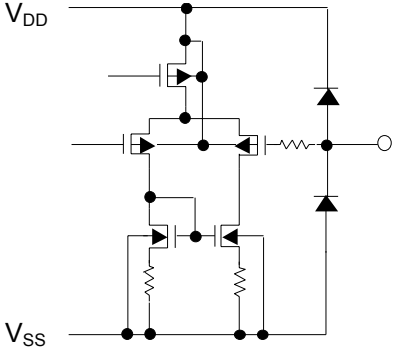
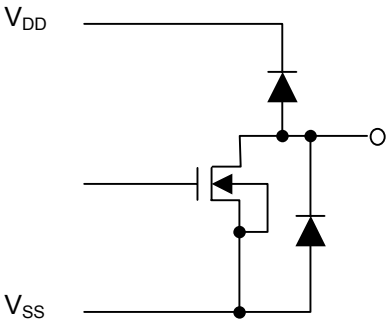
No.	Symbol	Equivalent Circuit	Typ. DC Voltage(V)	Function
1	IN-		-	inverting input
3	IN+		-	non-inverting input
4	OUT		-	output

TYPICAL CHARACTERISTICS

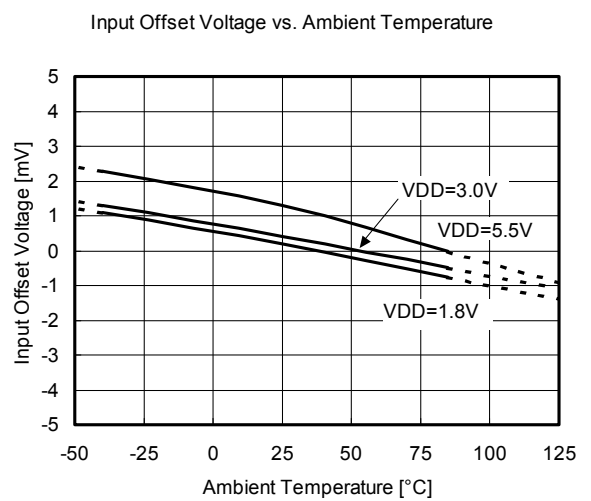
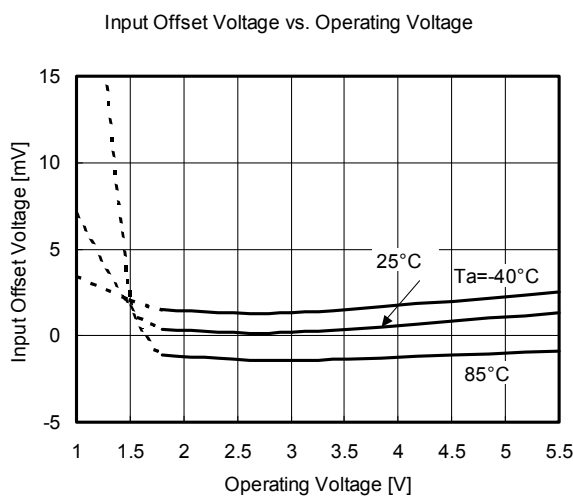
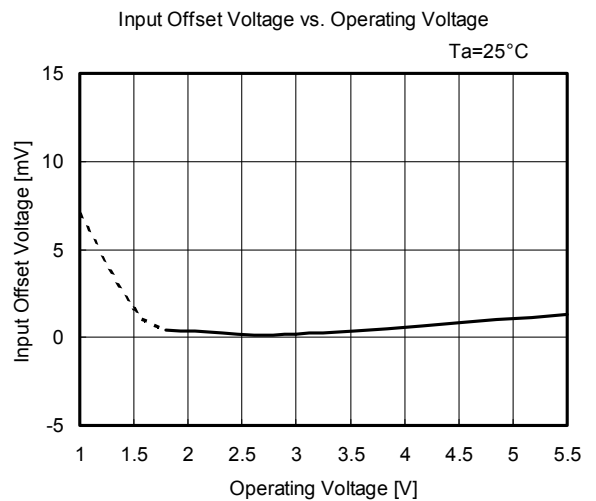
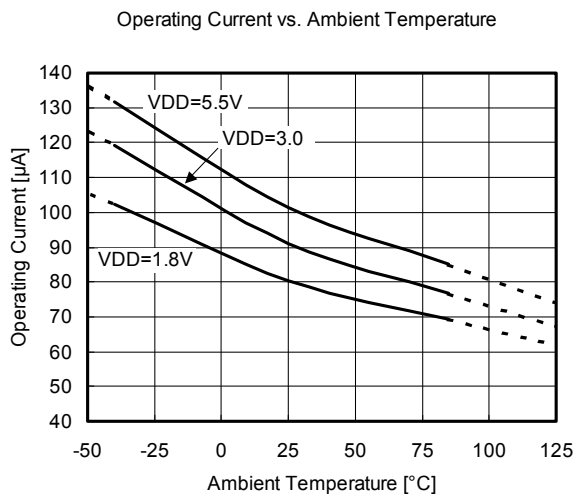
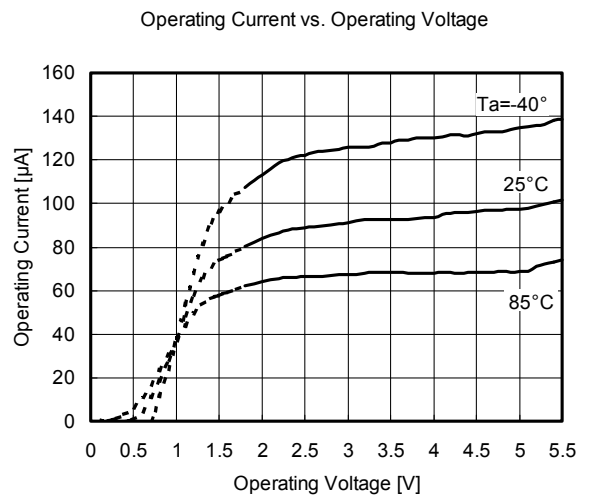
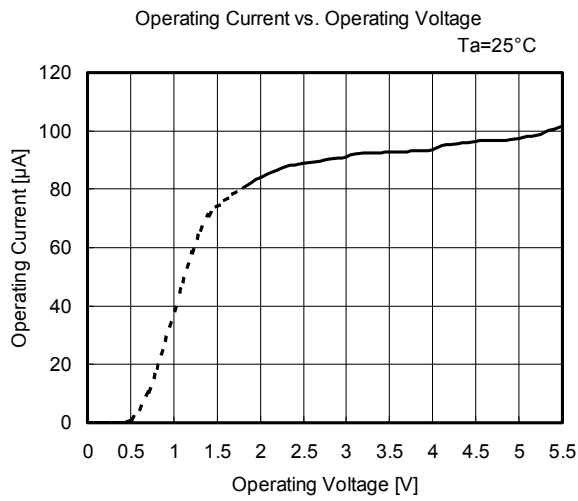

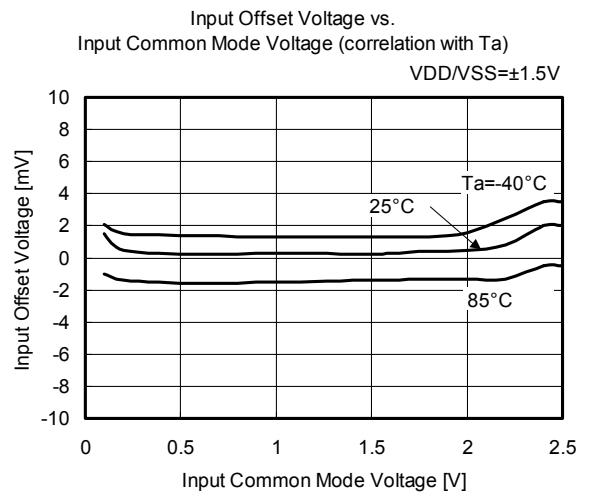
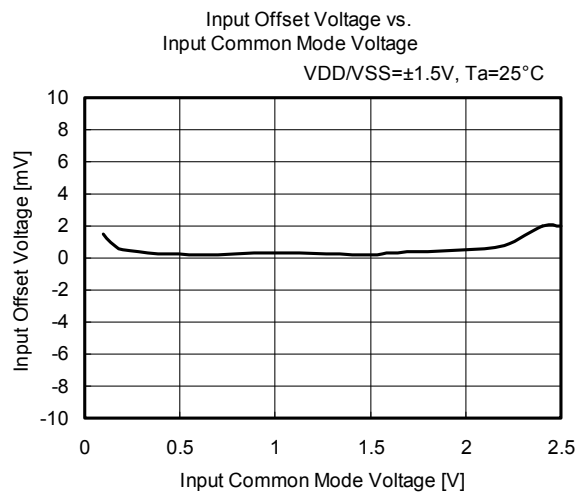
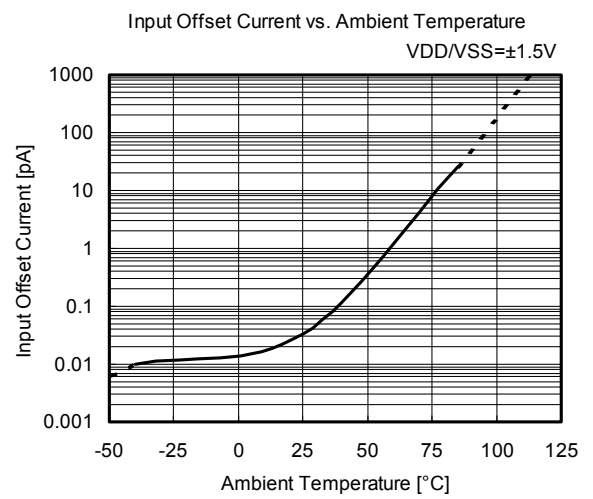
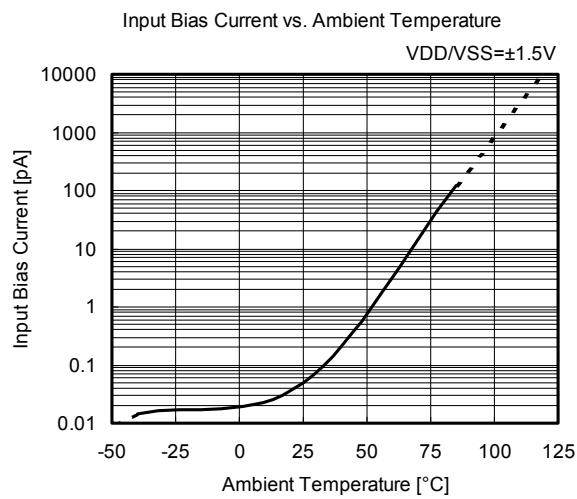

Low level Output Voltage vs. Ambient Temperature

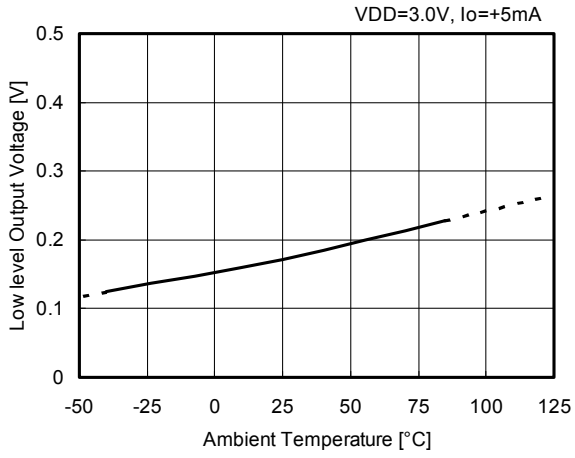

Low level Output Voltage vs. Output Current (correlation with T_a)

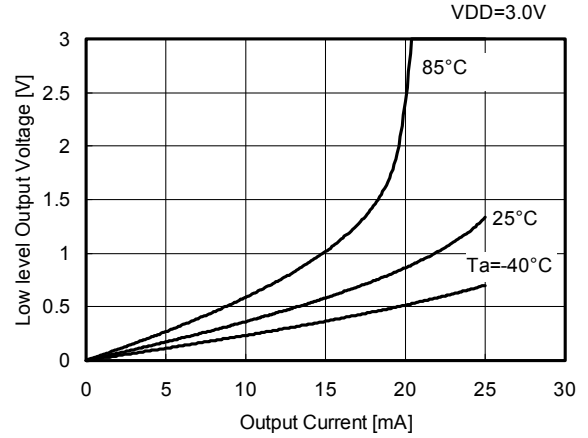

Low level Output Voltage vs. Output Current (correlation with T_a)

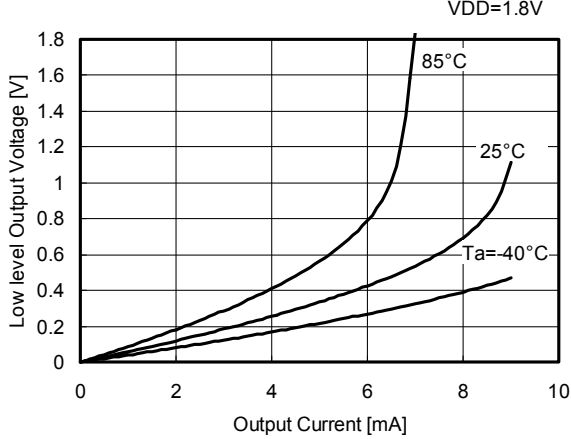

Low level Output Voltage vs. Output Current (correlation with T_a)

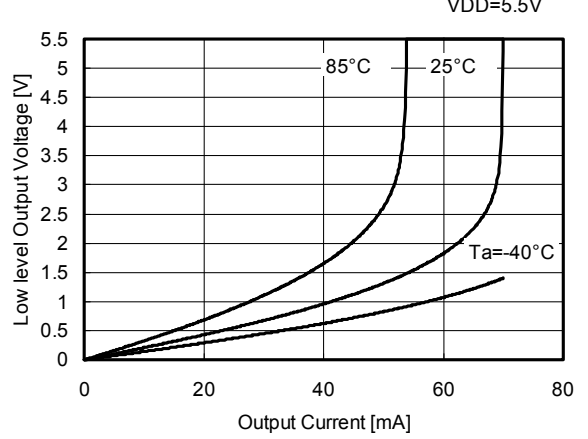

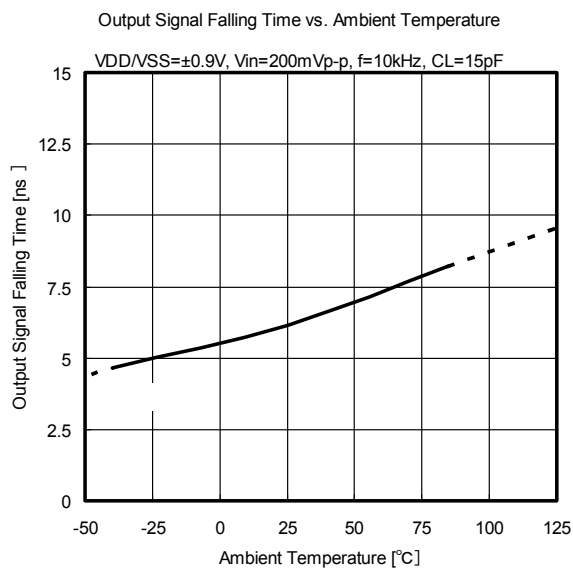
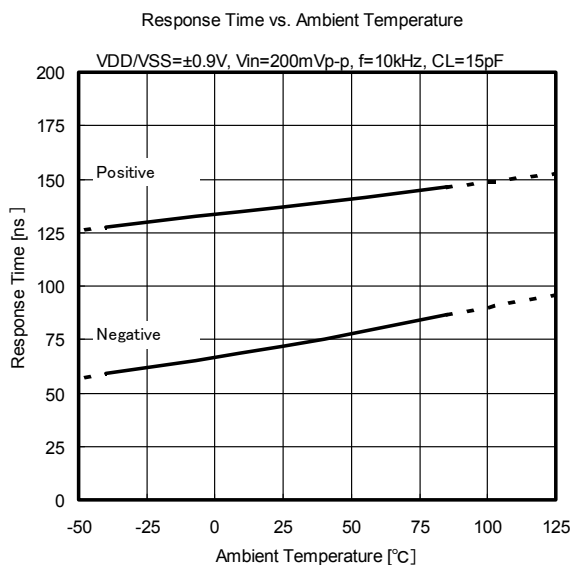
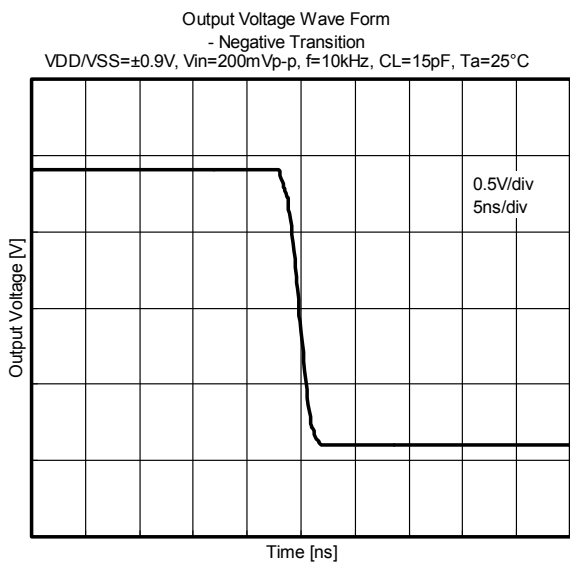
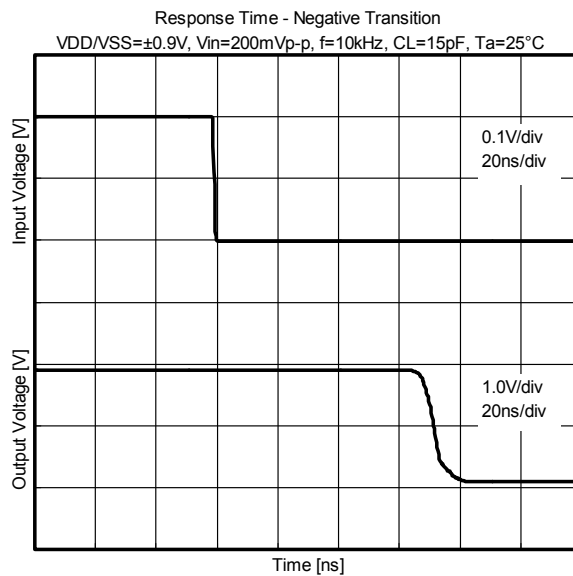
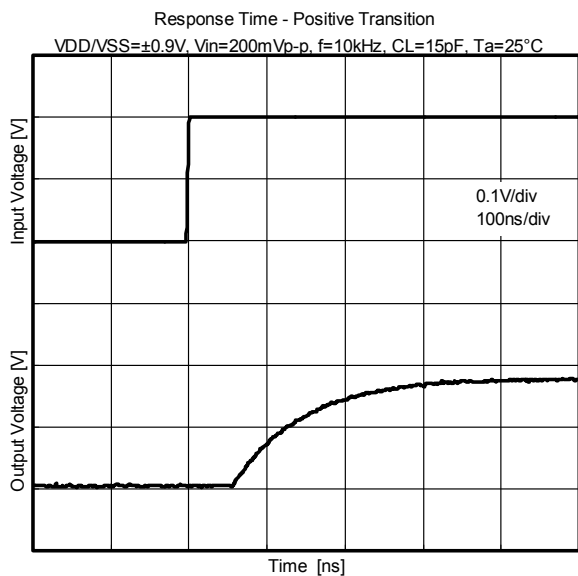

Response Time - Positive Transition

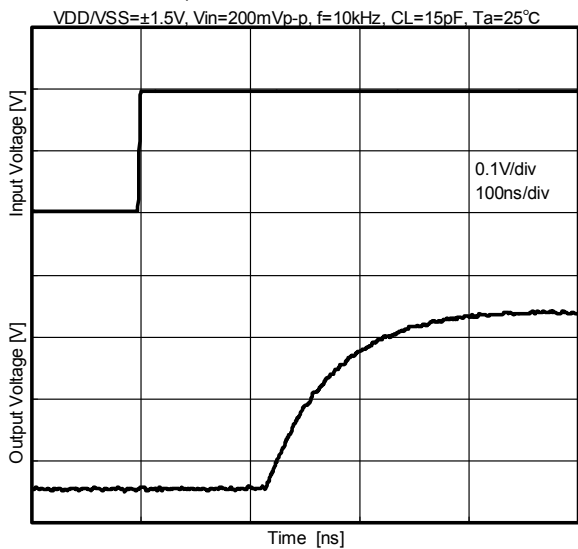

Response Time - Negative Transition

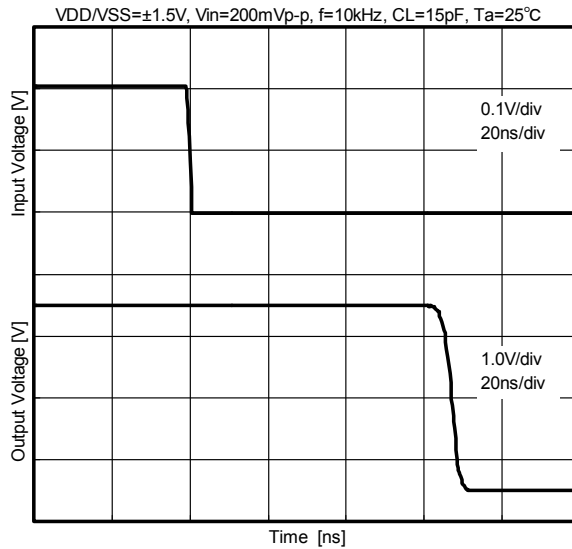

Output Voltage Wave Form

- Negative Transition

VDD/VSS=±1.5V, Vin=200mVp-p, f=10kHz, CL=15pF, Ta=25°C

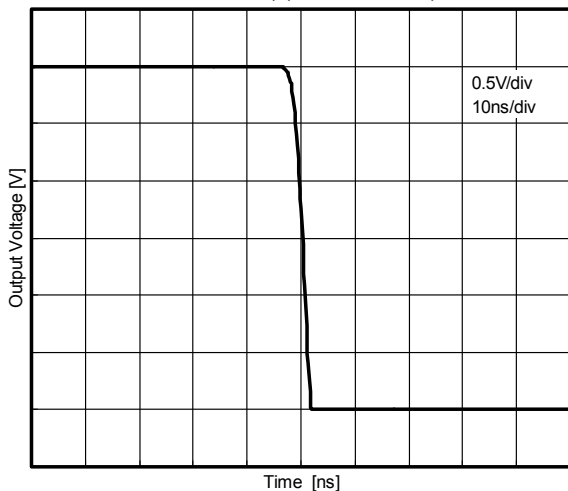

Response Time vs. Ambient Temperature

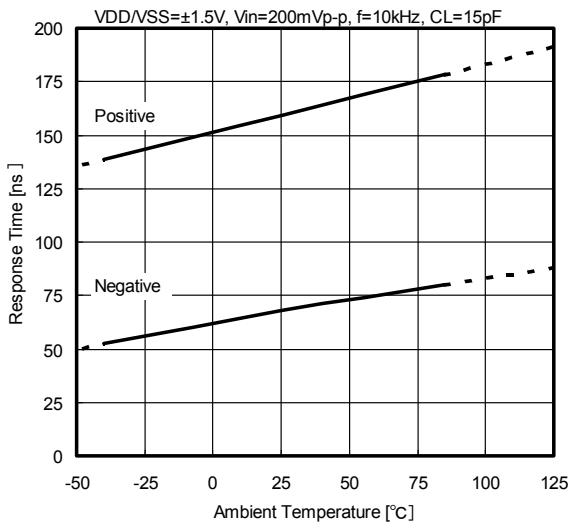

Output Signal Falling Time vs. Ambient Temperature

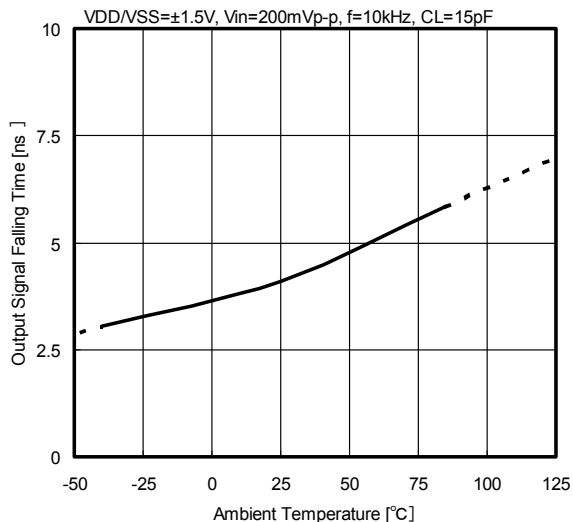

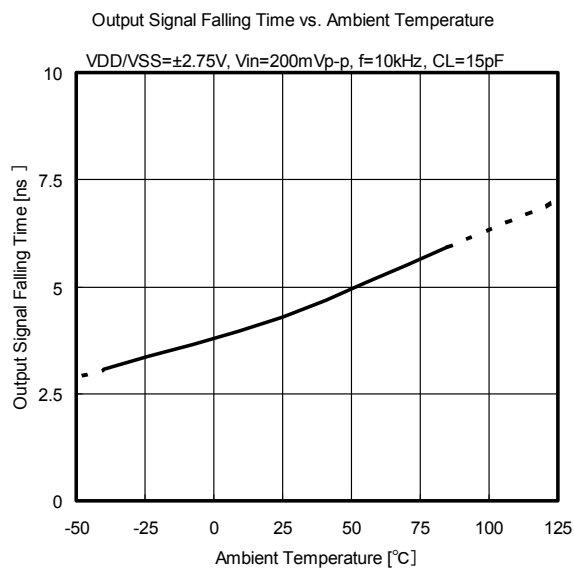
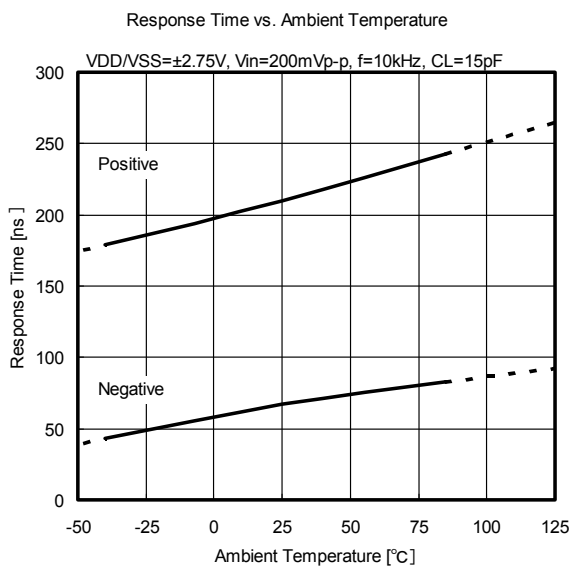
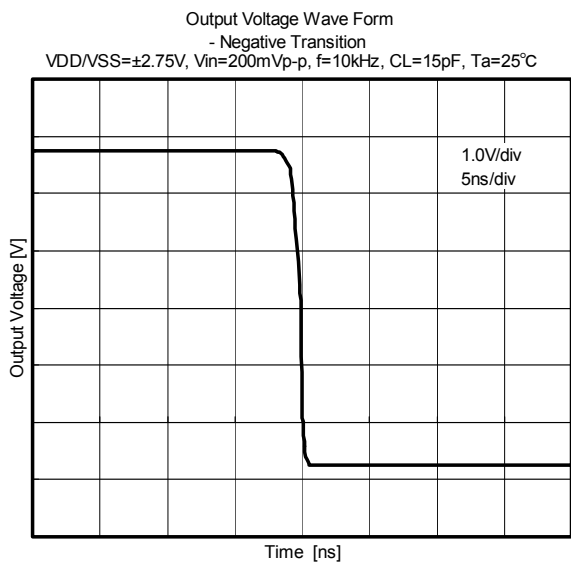
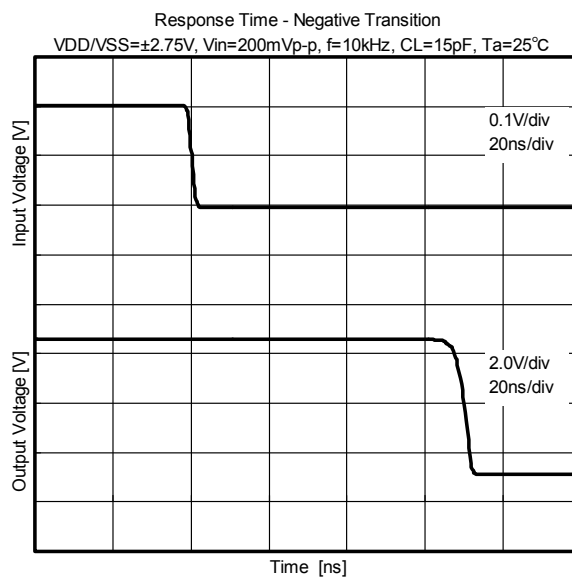
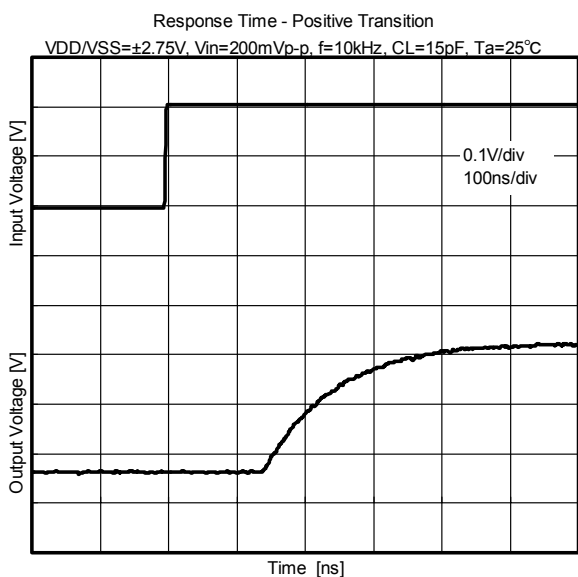

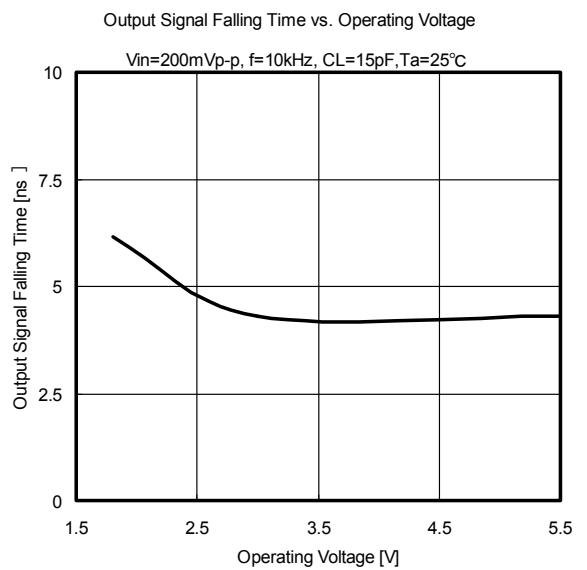
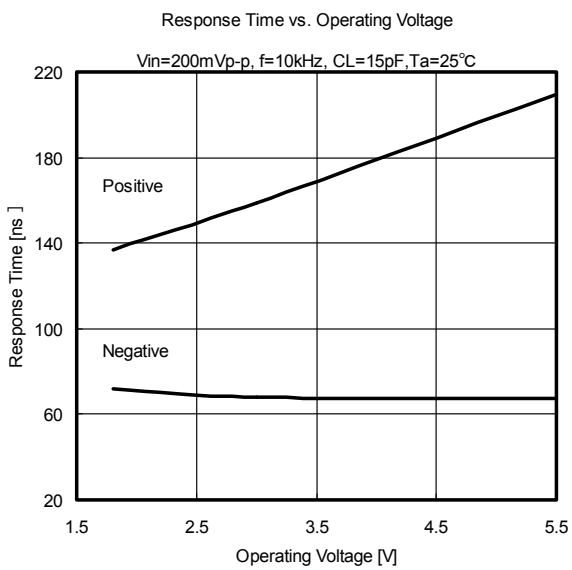

SWITCHING CHARACTERISTICS MEASUREMENT CIRCUIT

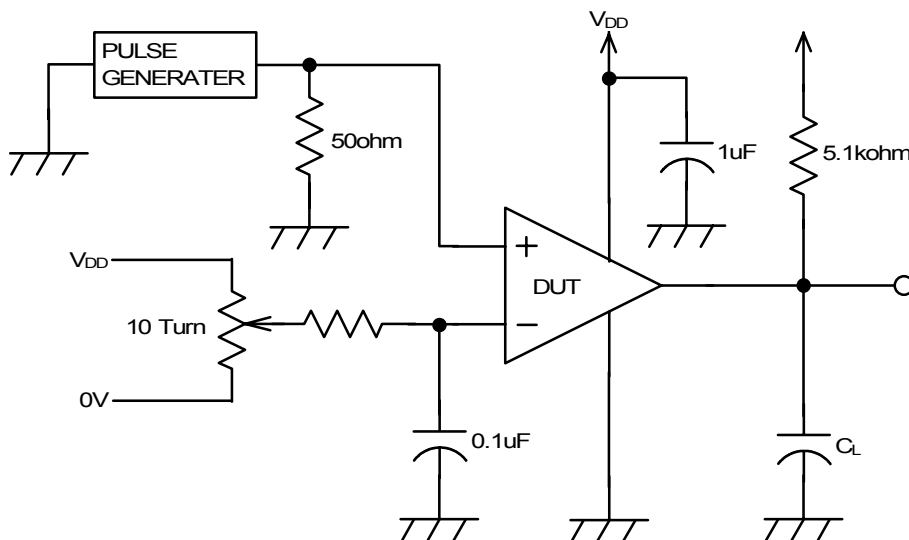

[CAUTION]
 The specifications on this data book are only given for information, without any guarantee as regards either mistakes or omissions. The application circuits in this data book are described only to show representative usages of the product and not intended for the guarantee or permission of any right including the industrial rights.