

**FEATURES/BENEFITS**

- Enhanced N channel FET with no inherent diode to  $V_{CC}$
- 16:8 multiplexer function with zero delay
- 5Ω bidirectional switches connect inputs to outputs
- Zero propagation delay, zero ground bounce
- Low power CMOS proprietary technology
- TTL compatible control inputs
- Undershoot clamp diodes on all control and switch pins
- Direct bidirectional connection for mux, demux
- QS32390 is 25Ω version for low noise
- Available in 28-pin SOIC (SO) & QSOP

**APPLICATIONS**

- Video, audio, graphics switching, muxing
- Hot-swapping, hot-docking (Application Note AN-13)
- Voltage translation (5V to 3.3V; Application Note AN-11)

**DESCRIPTION**

The QS3390 and QS32390 provide a 16:8 multiplexer logic switch. The low ON resistance (5Ω) of the QS3390 allows inputs to be connected to the outputs without adding propagation delay and without generating additional ground bounce noise. The QS32390 adds an internal 25Ω resistor to reduce reflection noise in high-speed applications. The enable inputs connect one of two inputs to the common I/O pin, respectively. The multiplexer function can be used to select and route logic signals for zero delay, isolate bus capacitance, form crossbar switches, etc.

Mux/Demux devices provide an order of magnitude faster speed than equivalent logic devices.



**Figure 1. Functional Block Diagram**

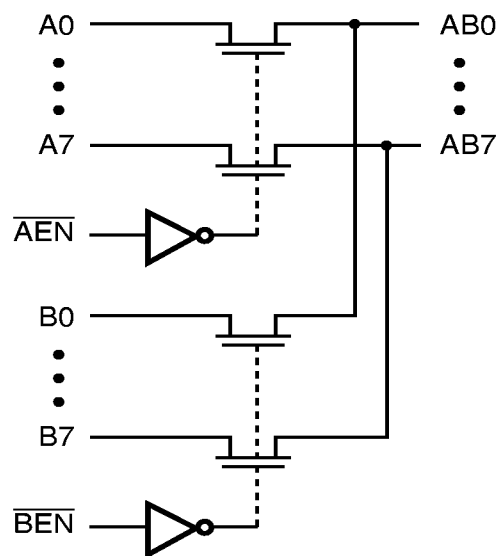

**Table 1. Pin Description**

Name	I/O	Description
A0-A9	I/O	Bus A
B0-B9	I/O	Bus B
$\overline{\text{AEN}}, \overline{\text{BEN}}$	I	Bus Switch Enable

**Table 2. Function Table**

$\overline{\text{AEN}}$	$\overline{\text{BEN}}$	A0-A9	B0-B9	Function
H	H	Off	Off	Disconnect
L	H	On	Off	A to AB
H	L	Off	On	B to AB
L	L	On	On	A, B to AB

**Figure 2. Pin Configuration (All Pins Top View)**

SOIC (SO), QSOP

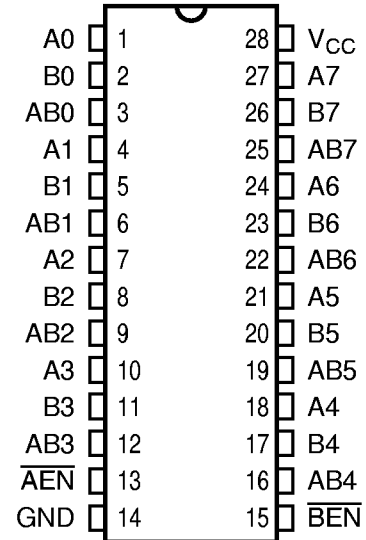

**Table 3. Absolute Maximum Ratings**

Supply Voltage to Ground .....	-0.5V to +7.0V
DC Switch Voltage $V_S$ .....	-0.5V to +7.0V
DC Input Voltage $V_{IN}$ .....	-0.5V to +7.0V
AC Input Voltage (for a pulse width $\leq 20\text{ns}$ ) .....	-3.0V
DC Output Current Max. Sink Current/Pin .....	120mA
Maximum Power Dissipation .....	0.5 watts
$T_{STG}$ Storage Temperature .....	-65° to +150°C

**Note:** ABSOLUTE MAXIMUM CONTINUOUS RATINGS are those values beyond which damage to the device may occur. Exposure to these conditions or conditions beyond those indicated may adversely affect device reliability. Functional operation under absolute-maximum conditions is not implied.

**Table 4. Capacitance**

$T_A = 25^\circ\text{C}$ ,  $f = 1\text{MHz}$ ,  $V_{IN} = 0\text{V}$ ,  $V_{OUT} = 0\text{V}$

Pins		SOIC, QSOP		Unit
		Typ	Max	
Control Inputs		4	5	pF
QuickSwitch Channels (Switch OFF)	Demux	5	7	pF
	Mux	9	10	pF

**Note:** Capacitance is guaranteed, but not tested and the values are typical. For total capacitance while the switch is ON, please see Section 1 under "Input and Switch Capacitance."

**Table 5. DC Electrical Characteristics Over Operating Range** $T_A = -40^\circ\text{C}$  to  $+85^\circ\text{C}$ ,  $V_{CC} = 5.0\text{V} \pm 5\%$ 

Symbol	Parameter	Test Conditions	Min	Typ <sup>(1)</sup>	Max	Unit	
$V_{IH}$	Input HIGH Voltage	Guaranteed Logic HIGH for Control Inputs	2.0	—	—	V	
$V_{IL}$	Input LOW Voltage	Guaranteed Logic LOW for Control Inputs	—	—	0.8	V	
$ I_{IN} $	Input Leakage Current (Control Inputs)	$0 \leq V_{IN} \leq V_{CC}$	—	—	1	$\mu\text{A}$	
$ I_{OZ} $	Off-State Current (Hi-Z)	$0 \leq V_{OUT} \leq V_{CC}$	—	—	1	$\mu\text{A}$	
$R_{ON}$	Switch ON Resistance <sup>(2)</sup>	$V_{CC} = \text{Min.}, V_{IN} = 0.0\text{V}$	3390	—	5	7	$\Omega$
		$I_{ON} = 30\text{mA}$	32390	20	28	40	
$R_{ON}$	Switch ON Resistance <sup>(2)</sup>	$V_{CC} = \text{Min.}, V_{IN} = 2.4\text{V}$	3390	—	10	15	$\Omega$
		$I_{ON} = 15\text{mA}$	32390	24	35	48	
$V_P$	Pass Voltage <sup>(3)</sup>	$V_{IN} = V_{CC} = 5\text{V}, I_{OUT} = -5\mu\text{A}$	3.7	4	4.2	V	

**Notes:**

1. Typical values indicate  $V_{CC} = 5.0\text{V}$  and  $T_A = 25^\circ\text{C}$ .
2. For a diagram explaining the procedure for  $R_{ON}$  measurement, please see Section 1 under "DC Electrical Characteristics." Max. value of  $R_{ON}$  guaranteed, but not production tested.
3. Pass voltage is guaranteed, but not production tested.

5

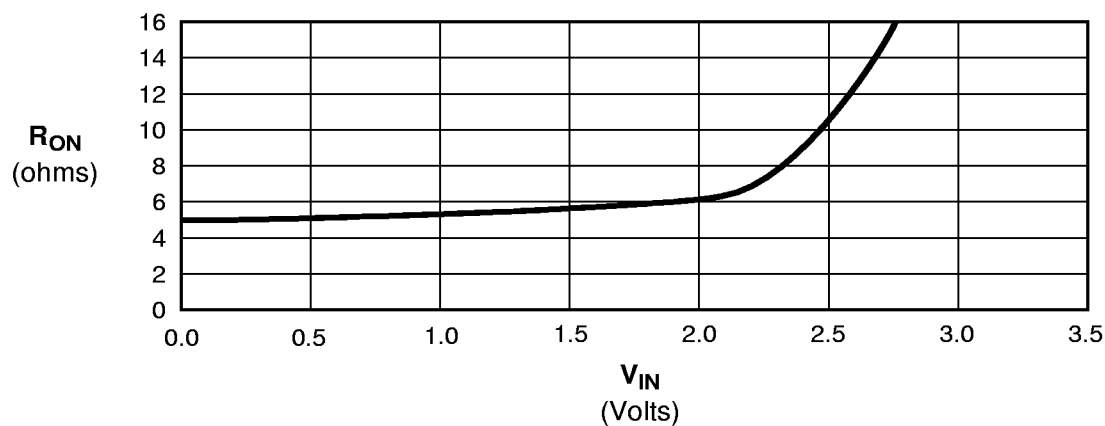
**Figure 3. Typical ON Resistance vs.  $V_{IN}$  at  $V_{CC} = 5.0\text{V}$  (QS3390)**

**Note:** For QS32390, add  $23\Omega$  to  $R_{ON}$  shown.

**Table 6. Power Supply Characteristics Over Operating Range**

$T_A = -40^{\circ}\text{C}$  to  $+85^{\circ}\text{C}$ ,  $V_{CC} = 5.0\text{V} \pm 5\%$

Symbol	Parameter	Test Conditions <sup>(1)</sup>	Max	Unit
$I_{CCQ}$	Quiescent Power Supply Current	$V_{CC} = \text{Max.}, V_{IN} = \text{GND or } V_{CC}, f = 0$	3	$\mu\text{A}$
$\Delta I_{CC}$	Power Supply Current per Input HIGH <sup>(2)</sup>	$V_{CC} = \text{Max.}, V_{IN} = 3.4\text{V}, f = 0$ per Control Input	1.5	mA
$Q_{CCD}$	Dynamic Power Supply Current per MHz <sup>(3)</sup>	$V_{CC} = \text{Max.}, A, B, AB$ Pins Open, Control Inputs Toggling @ 50% Duty Cycle	0.25	mA/MHz

**Notes:**

1. For conditions shown as Min. or Max., use the appropriate values specified under DC specifications.
2. Per TTL driven input ( $V_{IN} = 3.4\text{V}$ , control inputs only). A, B, and AB pins do not contribute to  $\Delta I_{CC}$ .
3. This current applies to the control inputs only and represents the current required to switch internal capacitance at the specified frequency. The A, B, and AB I/Os generate no significant AC or DC currents as they transition. This parameter is guaranteed, but not production tested.

**Table 7. Switching Characteristics Over Operating Range**

$T_A = -40^{\circ}\text{C}$  to  $+85^{\circ}\text{C}$ ,  $V_{CC} = 5.0\text{V} \pm 5\%$

$C_{LOAD} = 50\text{pF}$ ,  $R_{LOAD} = 500\Omega$  unless otherwise noted.

Symbol	Description <sup>(1)</sup>	QS3390			QS32390			Unit
		Min	Typ	Max	Min	Typ	Max	
$t_{PLH}$ $t_{PHL}$	Data Propagation Delay <sup>(2,4)</sup> A,B to/from AB	—	—	0.25 <sup>(3)</sup>	—	—	1.25 <sup>(3)</sup>	ns
$t_{PZL}$ $t_{PZH}$	Switch Turn-on Delay $\overline{AEN}/\overline{BEN}$ to A, B, AB	1.5	—	6.5	1.5	—	7.5	ns
$t_{PLZ}$ $t_{PHZ}$	Switch Turn-off Delay <sup>(2)</sup> $\overline{AEN}/\overline{BEN}$ to A, B, AB	1.5	—	5.5	—	—	5.5	ns

**Notes:**

1. See Test Circuit and Waveforms. Minimums guaranteed, but not production tested.
2. This parameter is guaranteed, but not production tested.
3. The time constant for the switch alone is of the order of 0.25ns for QS3390 and 1.25ns for QS32390 for  $C_L = 50\text{pF}$ .
4. The bus switch contributes no propagation delay other than the RC delay of the ON resistance of the switch and the load capacitance. Since this time constant is much smaller than the rise/fall times of typical driving signals, it adds very little propagation delay to the system. Propagation delay of the bus switch when used in a system is determined by the driving circuit on the driving side of the switch and its interaction with the load on the driven side.

**300-MIL SOIC - Package Code SO**  
Plastic Small Outline Gull-Wing

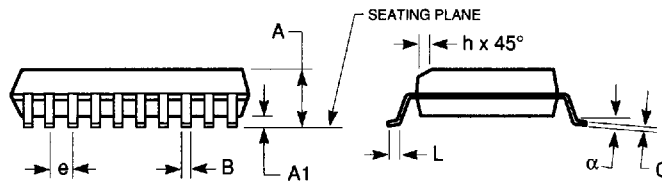
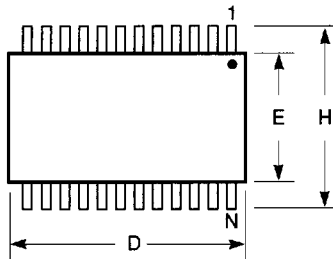

**Notes:**

1. Refer to applicable symbol list.
2. All dimensions are in inches.
3. N is the number of lead positions.
4. Dimensions D and E are to be measured at maximum material condition but do not include mold flash. Allowable mold flash is 0.006in. per side.
5. Lead coplanarity is 0.004in. maximum.

JEDEC#	MS-013AA		MS-013AC		MS-013AD		MS-013AE	
DWG#	PS16A		PS20A		PS24A		PS28A	
Symbol	Min	Max	Min	Max	Min	Max	Min	Max
A	0.096	0.104	0.096	0.104	0.096	0.104	0.096	0.104
A1	0.005	0.011	0.005	0.011	0.005	0.011	0.005	0.011
B	0.014	0.019	0.014	0.019	0.014	0.019	0.014	0.019
C	0.009	0.012	0.009	0.012	0.009	0.012	0.009	0.012
D	0.402	0.412	0.500	0.510	0.602	0.612	0.701	0.711
E	0.292	0.299	0.292	0.299	0.292	0.299	0.292	0.299
e	0.044	0.056	0.044	0.056	0.044	0.056	0.044	0.056
H	0.396	0.416	0.396	0.416	0.396	0.416	0.396	0.416
h	0.010	0.016	0.010	0.016	0.010	0.016	0.010	0.016
L	0.020	0.040	0.020	0.040	0.020	0.040	0.020	0.040
N	16		20		24		28	
$\alpha$	0°	8°	0°	8°	0°	8°	0°	8°

7466803 0003749 900

QUALITY SEMICONDUCTOR, INC.

**150-MIL QSOP - Package Code Q**

**Quarter-Size Outline Package  
Plastic Small Outline Gull-Wing**

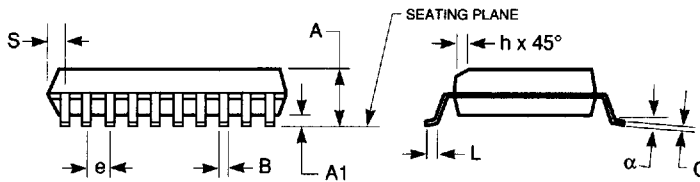
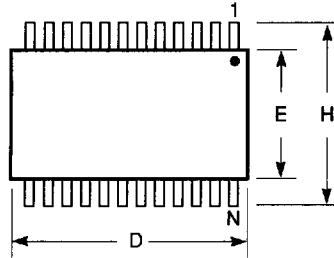

**Notes:**

1. Refer to applicable symbol list.
2. All dimensions are in inches.
3. N is the number of lead positions.
4. Dimensions D and E are to be measured at maximum material condition but do not include mold flash. Allowable mold flash is 0.006in. per side.
5. Lead coplanarity is 0.004in. maximum.

JEDEC#	MO-137AB			MO-137AD			MO-137AE			MO-137AF		
DWG#	PSS-16A			PSS-20A			PSS-24A			PSS-28A		
Symbol	Min	Nom	Max	Min	Nom	Max	Min	Nom	Max	Min	Nom	Max
A	0.060	0.064	0.068	0.060	0.064	0.068	0.060	0.064	0.068	0.060	0.064	0.068
A1	0.004	0.006	0.008	0.004	0.006	0.008	0.004	0.006	0.008	0.004	0.006	0.008
B	0.009	0.010	0.012	0.009	0.010	0.012	0.009	0.010	0.012	0.009	0.010	0.012
C	0.007	0.008	0.010	0.007	0.008	0.010	0.007	0.008	0.010	0.007	0.008	0.010
D	0.189	0.193	0.197	0.337	0.341	0.344	0.337	0.341	0.344	0.386	0.390	0.394
E	0.150	0.154	0.157	0.150	0.154	0.157	0.150	0.154	0.157	0.150	0.154	0.157
e	0.025 BSC			0.025 BSC			0.025 BSC			0.025 BSC		
H	0.230	0.236	0.244	0.230	0.236	0.244	0.230	0.236	0.244	0.230	0.236	0.244
h	0.010	0.013	0.016	0.010	0.013	0.016	0.010	0.013	0.016	0.010	0.013	0.016
L	0.016	0.025	0.035	0.016	0.025	0.035	0.016	0.025	0.035	0.016	0.025	0.035
N	16			20			24			28		
alpha	0°	5°	8°	0°	5°	8°	0°	5°	8°	0°	5°	8°
S	0.006	0.009	0.010	0.056	0.058	0.060	0.031	0.033	0.035	0.031	0.033	0.035

7466803 0003751 569  
QUALITY SEMICONDUCTOR, INC.