

**REMOTE CONTROL TRANSMITTER
FOR AUDIO AND VIDEO APPLICATIONS**

PRELIMINARY DATA

- TWO TIMING AND DATA FORMAT MODES
- 7 SUB-SYSTEM ADDRESSES
- UP TO 64 COMMANDS PER SUB-SYSTEM ADDRESS
- KEY RELEASE DETECTION BY TOGGLE BIT (1 toggle bit in mode A and 2 toggle bits in mode B)
- HIGH CURRENT REMOTE OUTPUT AT $V_{DD} = 3V$ ($-I_{OH} = 80mA$)
- VERY LOW STAND-BY CURRENT ($< 2\mu A$)
- 1mA OPERATIONAL CURRENT AT 6V SUPPLY
- CERAMIC RESONATOR CONTROLLED FREQUENCY (typ. 450kHz)
- MODULATED TRANSMISSION
- SUPPLY VOLTAGE RANGE 2V TO 6.5V
- LOW NUMBER OF EXTERNAL COMPONENTS

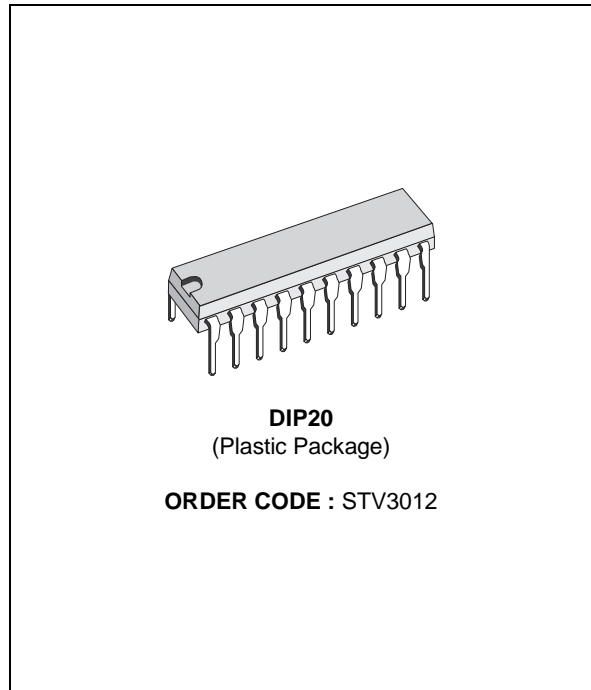

PIN CONNECTIONS

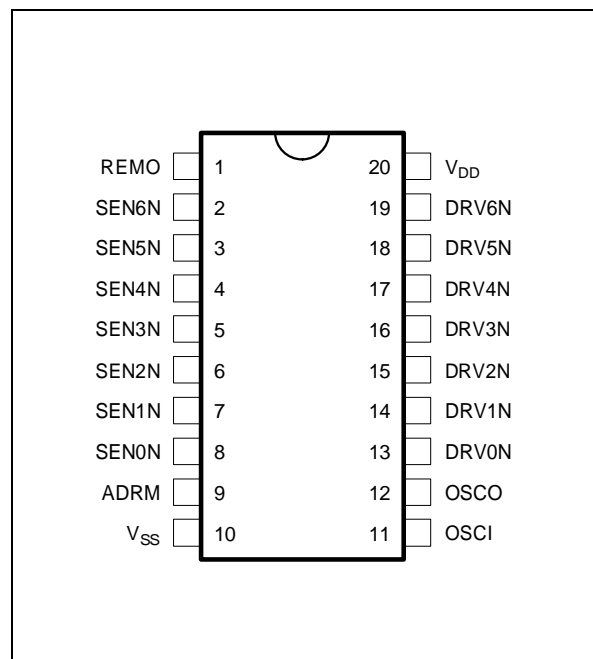

DESCRIPTION

The STV3012 is a general purpose infrared remote control transmitter system for low voltage supply applications. It is able to generate a total number of 448 commands which are divided into 7 sub-system groups with 64 commands each. The sub-system code may be selected by a press button, a slider switch or hard wired. Two different timing and data format modes are available.

BLOCK DIAGRAM

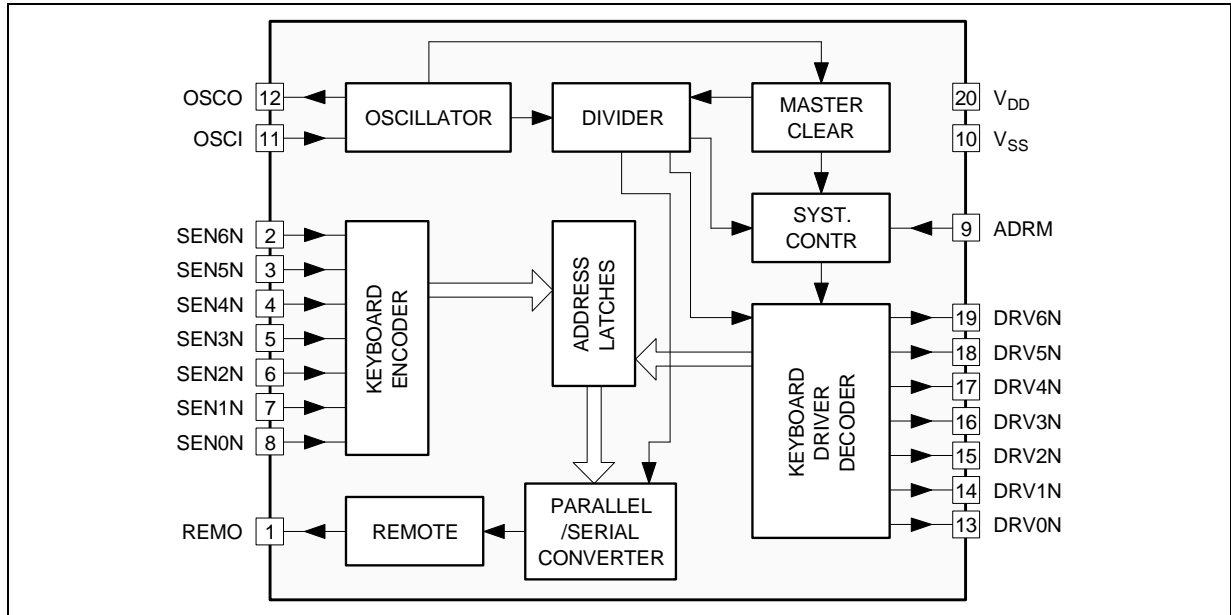

3012-02.EPS

ABSOLUTE MAXIMUM RATINGS

Symbol	Parameter	Value	Unit
V _{DD}	Supply Voltage	- 0.3, 7.0	V
V _I	Input Voltage	- 0.3, V _{DD} + 0.3	V
V _O	Output Voltage	- 0.3, V _{DD} + 0.3	V
± I	D.C. Current into any input or output	10	mA
- I _(REMO)	Peak REMO Output Current during 10µs, duty factor = 1%	300	mA
P _{tot}	Power Dissipation per package for T _{amb} = - 20 to + 70°C	200	mW
T _{stg}	Storage Temperature	- 55, + 125	°C
T _{oper}	Operating Ambient Temperature	-20, + 70	°C

3012-01.TBL

ELECTRICAL CHARACTERISTICS

V_{SS} = 0V, T_A = 25°C (unless otherwise specified)

Symbol	Parameter	Test Conditions	Min.	Typ.	Max.	Unit
V _{DD}	Supply Voltage	T _A = 0 to + 70°C	2		6.5	V
I _{DD}	Supply Current	<ul style="list-style-type: none"> Active f_{OSC} = 455kHz V_{DD} = 3V REMO Output unload V_{DD} = 6V Inactive (stand-by mode) V_{DD} = 6V 		0.25 1.0	0.5 2	mA mA
f _{OSC}	Oscill. Frequency	V _{DD} = 2 to 6.5V (ceramic resonator)	350		600	kHz

KEYBOARD MATRIX - Inputs SEN0N to SEN6N

V _{IL}	Input Voltage Low	V _{DD} = 2 to 6.5V			0.3 x V _{DD}	V
V _{IH}	Input Voltage High	V _{DD} = 2 to 6.5V	0.7 x V _{DD}			V
- I _I	Input Current	V _{DD} = 2V, V _I = 0V V _{DD} = 6.5V, V _I = 0V	10 100		100 600	µA µA
I _I	Input Leakage Current	V _{DD} = 6.5V, V _I = V _{DD}			1	µA

KEYBOARD MATRIX - Outputs DRV0N to DRV6N

V _{OL}	Output Voltage "ON"	V _{DD} = 2V, I _O = 0.1mA V _{DD} = 6.5V, I _O = 1.0mA			0.3 0.6	V V
I _O	Output Current "OFF"	V _{DD} = 6.5V, V _O = 6.5V			10	µA

3012-02.TBL

ELECTRICAL CHARACTERISTICS

$T_{amb} = 25^{\circ}\text{C}$, unless otherwise specified

Symbol	Parameter	Test Conditions	Min.	Typ.	Max.	Unit
CONTROL INPUT ADRM						
V_{IL}	Input Voltage Low				$0.3 \times V_{DD}$	V
V_{IH}	Input Voltage High		$0.7 \times V_{DD}$			V
I_{IL}	Input Current Low (switched P and N channel pull-up/pull down)	Pull-up Act. Oper. Condition, $V_{IN} = V_{SS}$ $V_{DD} = 2\text{V}$ $V_{DD} = 6.5\text{V}$	-10 -100		-100 -600	μA μA
I_{IH}	Input Current High (switched P and N channel pull-up/pull down)	Pull-down Act. Stand-by Cond., $V_{IN} = V_{DD}$ $V_{DD} = 2\text{V}$ $V_{DD} = 6.5\text{V}$	10 100		100 600	μA μA

DATA OUTPUT REMO

$-I_{OH}$	Output Current High	$V_{DD} = 2.5\text{V}$, $V_{OH} = 0.8\text{V}$, $T_A = 70^{\circ}\text{C}$ $V_{DD} = 2.5\text{V}$, $V_{OH} = 0.8\text{V}$, $T_A = 25^{\circ}\text{C}$ $V_{DD} = 6.5\text{V}$, $V_{OH} = 5\text{V}$	70 80 80			mA mA mA
I_{OL}	Output Current Low	$V_{DD} = 2\text{V}$, $V_{OL} = 0.4\text{V}$ $V_{DD} = 6.5\text{V}$, $V_{OL} = 0.4\text{V}$	0.6 0.6			mA mA
t_{OH}	Pulse Length	$V_{DD} = 6.5\text{V}$, Oscill. Stopped			1	msec

OSCILLATOR

I_i	Input Current	OSCI at V_{DD} $V_{DD} = 2\text{V}$ $V_{DD} = 6.5\text{V}$	5		5 7	μA μA
V_{OH}	Output Voltage high	$V_{DD} = 6.5\text{V}$, $-I_{OH} = 0.1\text{mA}$	$V_{DD} - 0.8$			V
V_{OL}	Output Voltage Low	$V_{DD} = 6.5\text{V}$, $I_{OL} = 0.1\text{mA}$			0.7	V

3012-03.TBL

I - INPUTS AND OUTPUTS**I.1 - Key Matrix Inputs and Outputs (DRV0N to DRV6N and SEN0N to SEN6N)**

The transmitter keyboard is arranged as a scanned matrix. The matrix consists of 7 driver outputs and 7 sense inputs. The driver outputs DRV0N to DRV6N are open drain N-channel transistors and they are conductive in the stand-by mode. The 7 sense inputs (SEN0N to SEN6N) enable the generation of 56 command codes. With 2 external diodes all 64 commands are addressable. The sense inputs have P-channel pull-up transistors so that they are HIGH until they are pulled LOW by connecting them to an output via a key depression to initiate a code transmission. The codes for the selected key are given in Table 1.

I.2 - Address Mode Input (ADRM)

The sub-system address and the transmission mode are defined by connecting the ADRM input to one or more driver outputs (DRV0N to DRV6N) of the key matrix. If more than one driver is connected to ADRM, they must be decoupled by diodes. This allows the definition of seven sub-system addresses as shown in Table 2.

The ADRM input has switched pull-up and pull-down loads. In the stand-by mode only the pull-

down device is active. Whether ADRM is open (sub-system address 0) or connected to the driver outputs, this input is LOW and will not cause unwanted dissipation. When the transmitter becomes active by pressing a key, the pull-down device is switched-off and the Pull-up device is switched-on, so that the applied driver signals are sensed for the decoding of the sub-system address and the mode of transmission.

The arrangement of the sub-system address coding is such that only the driver DRVnN with the highest number (n) defines the sub-system address, e.g. in mode B, if drivers DRV2N and DRV4N are connected to ADRM, only DRV4N will define the sub-system address. This option can be used in systems requiring more than one sub-system address. The transmitter may be hard-wire for sub-system address 2 by connecting DRV1N to ADRM. If now DRV3N is added to ADRM by a key or a switch, the transmitted sub-system address changes to 4. A change of the sub-system will not start a transmission.

I.3 - Remote Control Signal Output (REMO)

The REMO signal output stage is a push-pull type. In the HIGH state, a bipolar emitter-follower allows a high output current. The timing of the data output format is listed in Figures 1 and 2.

The information is defined by the first edge of the modulated pulses. During mode A, the data word starts with the four bits for defining the sub-system address S3, S2, S1 and S0, followed by the toggle bit T0, and seven bits G, F, E, D, C, B and A, which are defined by the selected key. During mode B, the data word starts with the Toggle bits T1 and T0, followed by three bits for defining the sub-system address S2, S1 and S0, and six bits F, E, D, C, B and A which are defined by the selected key.

The toggle bits function as an indication for the decoder that the next instruction has to be considered as a new command.

The REMO output is protected against "lock-up", i.e. the length of an output pulse is limited to < 1msec, even if the oscillator stops during an output pulse. This avoids the rapid discharge of the battery that would otherwise be caused by the continuous activation of the LED.

Table 1 : Key Codes

Matrix Drive	Matrix Sense	Code								Matrix Position
		G**	F	E	D	C	B	A		
DRV0N	SEN0N	0	0	0	0	0	0	0	0	0
DRV1N	SEN0N	0	0	0	0	0	0	0	1	1
DRV2N	SEN0N	0	0	0	0	0	0	1	0	2
DRV3N	SEN0N	0	0	0	0	0	0	1	1	3
DRV4N	SEN0N	0	0	0	0	1	0	0	0	4
DRV5N	SEN0N	0	0	0	0	1	0	1	1	5
DRV6N	SEN0N	0	0	0	0	1	1	0	0	6
Vss	SEN0N	0	0	0	0	1	1	1	1	7
DRV0N to Vss	SEN1N	0	0	0	1			*		8 to 15
DRV0N to Vss	SEN2N	0	0	1	0			*		16 to 23
DRV0N to Vss	SEN3N	0	0	1	1			*		24 to 31
DRV0N to Vss	SEN4N	0	1	0	0			*		32 to 39
DRV0N to Vss	SEN5N	0	1	0	1			*		40 to 47
DRV0N to Vss	SEN6N	0	1	1	0			*		48 to 55
DRV0N to Vss	SEN5N and SEN6N	0	1	1	1			*		56 to 63

* The C, B and A codes are identical to SEN0N as given above.
 ** Bit position G only available in mode A.

Table 2 : Transmission Mode and Sub-system Address Selection

Mode	Sub-system Address					Driver DRVnN for n =						
	#	S3	S2	S1	S0	0	1	2	3	4	5	6
MODE A	0	0	0	0	0							
	1	0	0	1	0	X	X	X	X	X	O	
	2	0	1	1	0	X	X	X	X	O		
	3	0	0	0	1	X	X	X	O			
	4	0	1	0	1	X	X	O				
	5	0	0	1	1	X	O					
	6	0	1	1	1	O						
MODE B	0		1	1	1							O
	1		0	0	0	O						O
	2		0	0	1	X	O					O
	3		0	1	0	X	X	O				O
	4		0	1	1	X	X	X	O			O
	5		1	0	0	X	X	X	X	O		O
	6		1	0	1	X	X	X	X	X	O	O

O = connected to ADRM
 blank = not connected to ADRM
 X = don't care

The sub-system address and the transmission mode are defined by connecting the ADRM input to one or more driver outputs (DRV0N to DRV6N) of the key matrix. If more than one driver is connected to ADRM, they must be decoupled by diodes.

Figure 1 : Data Format of REMO ; T0 and T1 = toggle bits ; S0, S1, S2 and S3 = sub-system address ; A, B, C, D, E, F and G = command bits

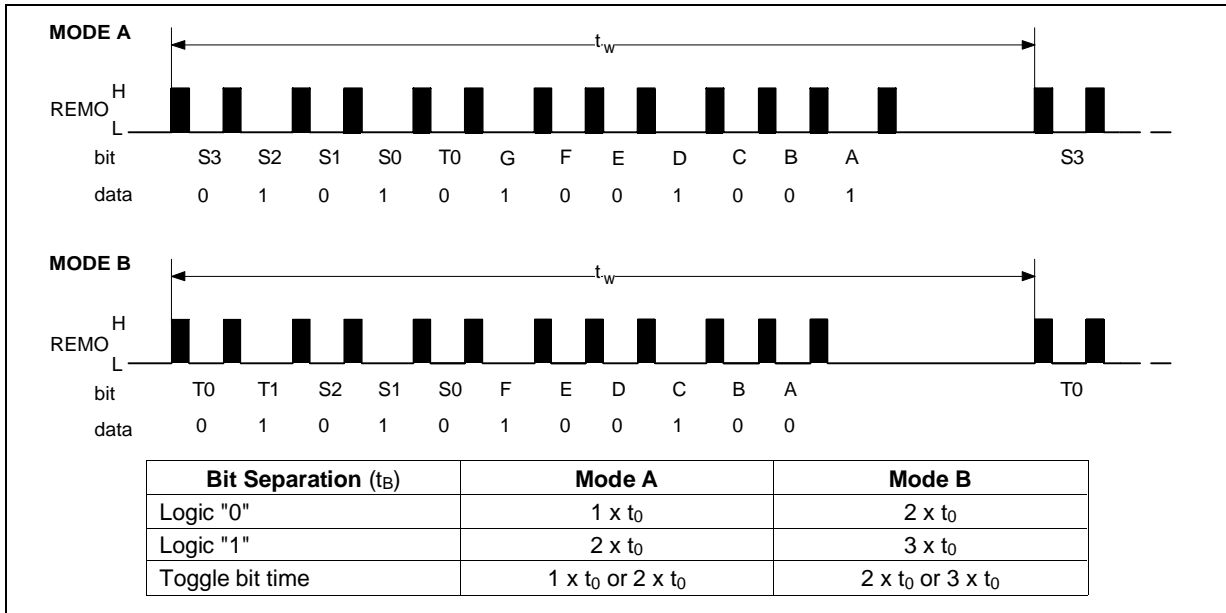
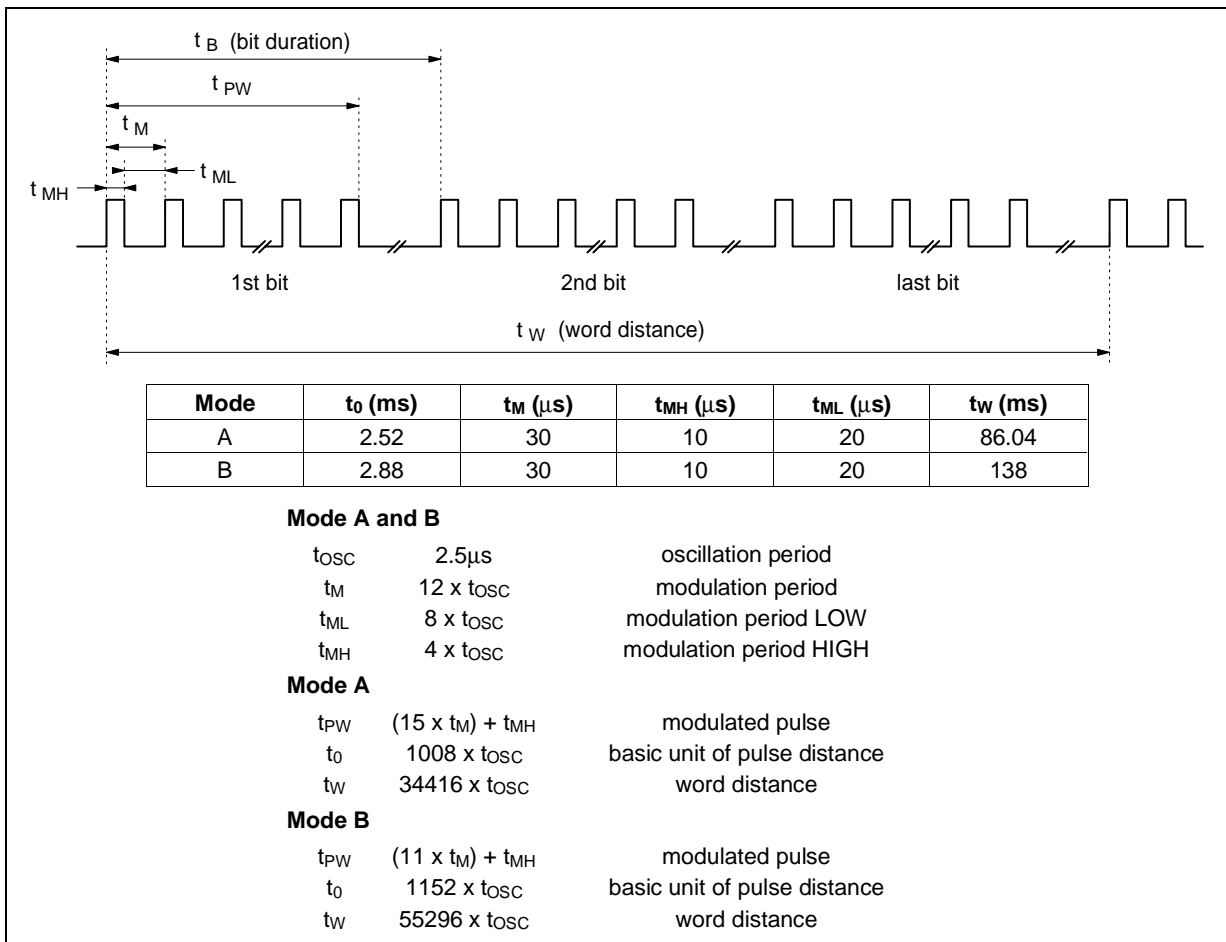

Figure 2 : Pulse Train Timing (ref. to $f_{osc} = 400kHz$)



I.4 - Oscillator Input and Output

The external components must be connected to these pins when using an oscillator with a ceramic resonator. The oscillator frequency may vary between 350kHz and 600kHz as defined by the resonator. No external feedback resistor is allowed.

II - FUNCTIONAL DESCRIPTION

Key operation (see Figure 3) :

In the stand-by mode all drivers (DRV0N to DRV6N) are on (low impedance to V_{SS}). Whenever a key is pressed, one or more of the sense inputs (SENnN) are tied to ground. This will start the power-up sequence. First the oscillator is activated and after the debounce time t_{DB} the output drivers (DRV0N to DRV6N) become active successively. Within the first scan cycle, the transmission mode, the applied sub-system address and the selected command code are sensed and loaded into an internal data latch.

In contrast to the command code, the sub-system is sensed only within the first scan cycle. If the applied sub-system address is changed while the Command key is pressed, the transmitted sub-system address is not altered.

In a multiple key stroke sequence the command code is always altered in accordance with the sensed key.

III - OUTPUT SEQUENCE (DATA FORMAT)

The output operation will start when the selected

code is found. A burst of pulses, including the latched address and command codes, is generated at the output REMO as long as a key is pressed. The operation is terminated by releasing the key or if more than one key is pressed at the same time. Once a sequence is started, the transmitted data words will always be completed after the key is released.

The toggle bits T1 and T0, during mode A only T0, toggle if the key is released for a minimum time t_{REL} . The toggle bits remain unchanged within a multiple key-stroke sequence.

IV - MULTIPLE KEY-STROKE PROTECTION

The keyboard is protected against multiple key-strokes (Figure 4). If more than one key is pressed at the same time, the circuit will not generate a new output at REMO. In case of a multiple key-stroke, the scan repetition rate is increased to detect the release of a key as soon as possible.

There are two restrictions caused by the special structure of the keyboard matrix : the keys switching to ground (code numbers 7, 15, 23, 31, 39, 47, 55 and 63) and the keys connected to SEN5N and SEN6N are not covered completely by the multiple key protection. If one sense input is switched to ground, further keys on the same sense line are ignored, i.e. the command code corresponding to "key to ground" is transmitted. SEN5N and SEN6N are not protected against multiple keystroke on the same driver line, because this condition has been used for the definition of additional codes (code number 56 to 63).

Figure 3 : Single Key-stroke Sequence. Debounce time : $t_{DB} = 4$ to $9 \times t_0$, Start time : $t_{ST} = 5$ to $10 \times t_0$, Minimum release time : $t_{REL} = t_0$.

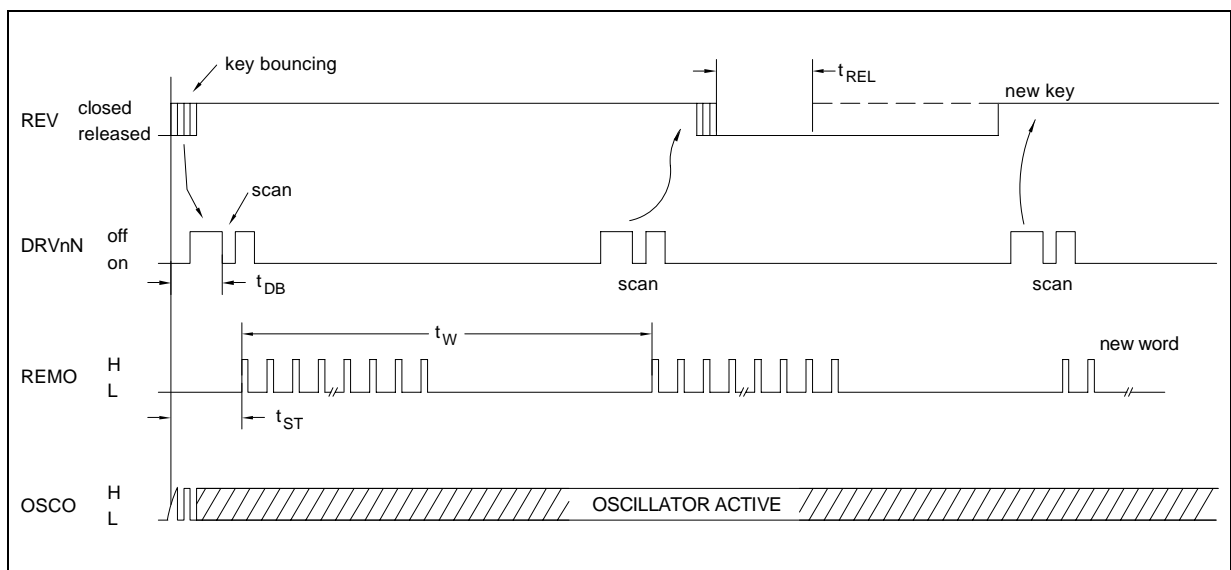
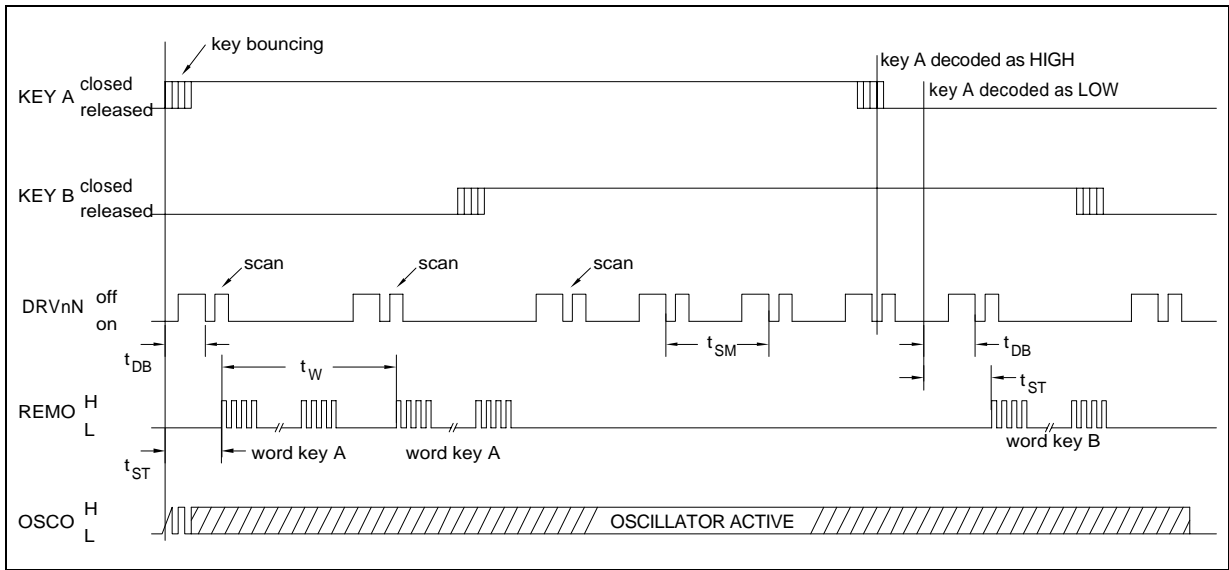
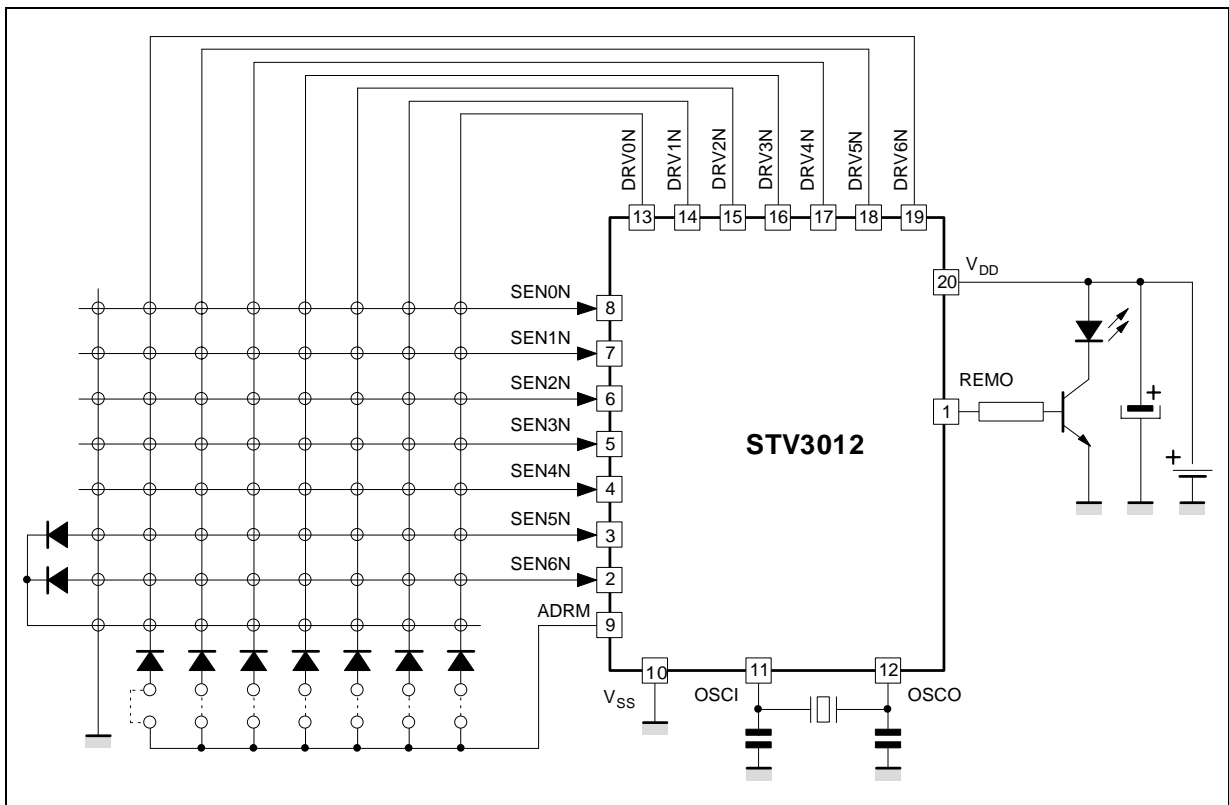

Figure 4 : Multiple Key-stroke Sequence. Scan rate multiple key-stroke : $t_{SM} = 8 \text{ to } 10 \times t_0$.



3012-06.EPS

TYPICAL APPLICATION



3012-07.EPS

PACKAGE MECHANICAL DATA
20 PINS - PLASTIC DIP

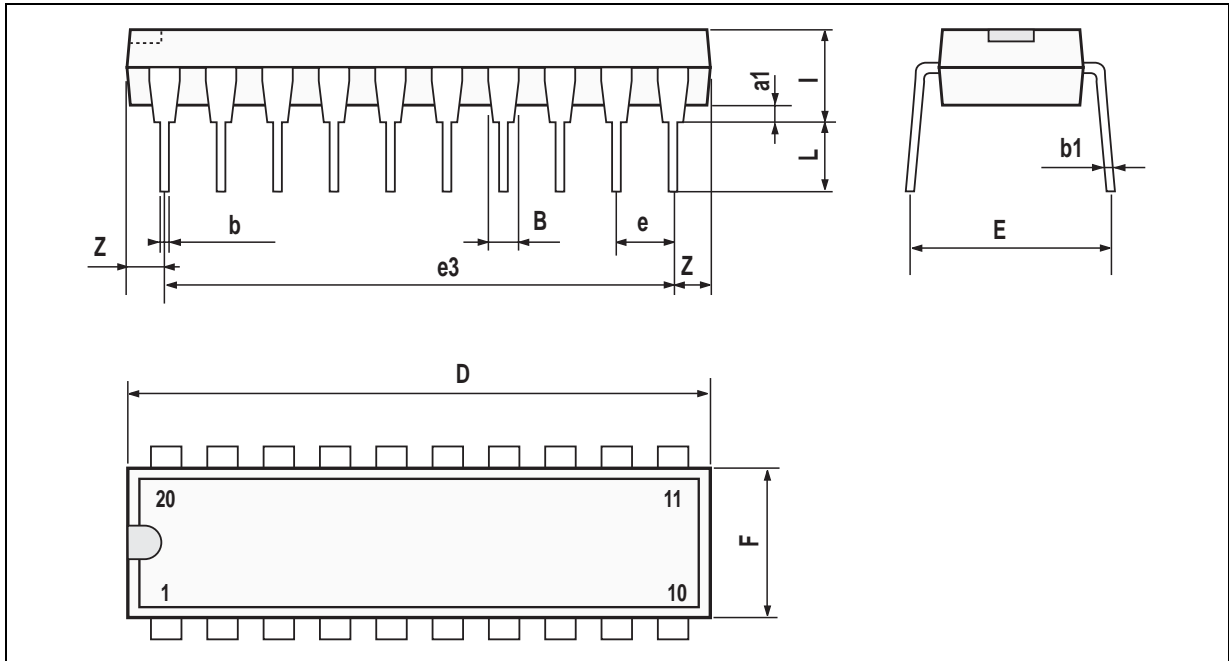

PM-DIP20.EPS

Dimensions	Millimeters			Inches		
	Min.	Typ.	Max.	Min.	Typ.	Max.
a1	0.254			0.010		
B	1.39		1.65	0.055		0.065
b		0.45			0.018	
b1		0.25			0.010	
D			25.4			1.000
E		8.5			0.335	
e		2.54			0.100	
e3		22.86			0.900	
F			7.1			0.280
i			3.93			0.155
L		3.3			0.130	
Z			1.34			0.053

DIP20.TBL

Information furnished is believed to be accurate and reliable. However, SGS-THOMSON Microelectronics assumes no responsibility for the consequences of use of such information nor for any infringement of patents or other rights of third parties which may result from its use. No licence is granted by implication or otherwise under any patent or patent rights of SGS-THOMSON Microelectronics. Specifications mentioned in this publication are subject to change without notice. This publication supersedes and replaces all information previously supplied. SGS-THOMSON Microelectronics products are not authorized for use as critical components in life support devices or systems without express written approval of SGS-THOMSON Microelectronics.

© 1994 SGS-THOMSON Microelectronics - All Rights Reserved

Purchase of I²C Components of SGS-THOMSON Microelectronics, conveys a license under the Philips I²C Patent. Rights to use these components in a I²C system, is granted provided that the system conforms to the I²C Standard Specifications as defined by Philips.

SGS-THOMSON Microelectronics GROUP OF COMPANIES

Australia - Brazil - China - France - Germany - Hong Kong - Italy - Japan - Korea - Malaysia - Malta - Morocco
The Netherlands - Singapore - Spain - Sweden - Switzerland - Taiwan - Thailand - United Kingdom - U.S.A.