

**FEATURES**

128-position  
End-to-end resistance 5 k $\Omega$ , 10 k $\Omega$ , 50 k $\Omega$ , 100 k $\Omega$   
Ultracompact SC70-6 (2 mm  $\times$  2.1 mm) package  
I<sup>2</sup>C<sup>®</sup> compatible interface  
Full read/write of wiper register  
Power-on preset to midscale  
Single supply 2.7 V to 5.5 V  
Low temperature coefficient 45 ppm/ $^{\circ}$ C  
Low power, I<sub>DD</sub> = 3  $\mu$ A typical  
Wide operating temperature  $-40^{\circ}$ C to  $+125^{\circ}$ C  
Evaluation board available

**APPLICATIONS**

Mechanical potentiometer replacement in new designs  
Transducer adjustment of pressure, temperature, position,  
chemical, and optical sensors  
RF amplifier biasing  
Automotive electronics adjustment  
Gain control and offset adjustment

**GENERAL OVERVIEW**

The AD5246 provides a compact 2 mm  $\times$  2.1 mm packaged solution for 128-position adjustment applications. This device performs the same electronic adjustment function as a variable resistor. Available in four different end-to-end resistance values (5 k $\Omega$ , 10 k $\Omega$ , 50 k $\Omega$ , 100 k $\Omega$ ), these low temperature coefficient devices are ideal for high accuracy and stability variable resistance adjustments.

The wiper settings are controllable through the I<sup>2</sup>C compatible digital interface, which can also be used to read back the present wiper register control word. The resistance between the wiper and either end point of the fixed resistor varies linearly with respect to the digital code transferred into the RDAC<sup>1</sup> latch.

Operating from a 2.7 V to 5.5 V power supply and consuming 3  $\mu$ A allows for usage in portable battery-operated applications.

**FUNCTIONAL BLOCK DIAGRAM**

Figure 1.

<sup>1</sup> Note: The terms digital potentiometer, VR, and RDAC are used interchangeably in this document.

**Rev. 0**

Information furnished by Analog Devices is believed to be accurate and reliable. However, no responsibility is assumed by Analog Devices for its use, nor for any infringements of patents or other rights of third parties that may result from its use. Specifications subject to change without notice. No license is granted by implication or otherwise under any patent or patent rights of Analog Devices. Trademarks and registered trademarks are the property of their respective companies.

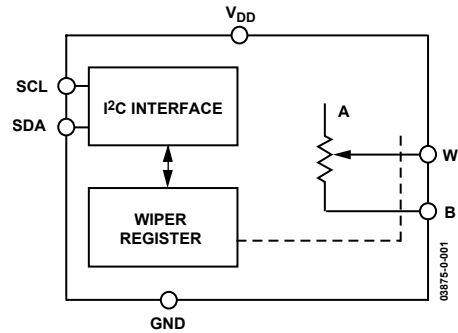
**TABLE OF CONTENTS**

|   |    |  |    |
|---|----|--|----|
| Electrical Characteristics—5 k $\Omega$ Version .....   | 3  | ESD Protection .....                             | 13 |
| Electrical Characteristics—10 k $\Omega$ , 50 k $\Omega$ , 100 k $\Omega$ Versions .....            | 4  | Terminal Voltage Operating Range.....            | 14 |
| Timing Characteristics—5 k $\Omega$ , 10 k $\Omega$ , 50 k $\Omega$ , 100 k $\Omega$ Versions ..... | 5  | Maximum Operating Current .....                  | 14 |
| Absolute Maximum Ratings.....   | 6  | Power-Up Sequence .....                          | 14 |
| Typical Performance Characteristics .....   | 7  | Layout and Power Supply Bypassing .....          | 14 |
| Test Circuits.....  | 10 | Constant Bias to Retain Resistance Setting.....  | 15 |
| I <sup>2</sup> C Interface.....   | 11 | Evaluation Board .....                           | 15 |
| Operation.....  | 12 | Pin Configuration and Function Descriptions..... | 16 |
| Programming the Variable Resistor .....   | 12 | Outline Dimensions .....                         | 17 |
| I <sup>2</sup> C Compatible 2-Wire Serial Bus.....  | 13 | Ordering Guide .....                             | 17 |
| Level Shifting for Bidirectional Interface .....  | 13 |  |    |

**REVISION HISTORY**

Revision 0: Initial Version

## ELECTRICAL CHARACTERISTICS—5 k $\Omega$ VERSION

Table 1.  $V_{DD} = 5\text{ V} \pm 10\%$  or  $3\text{ V} \pm 10\%$ ;  $V_A = +V_{DD}$ ;  $-40^\circ\text{C} < T_A < +125^\circ\text{C}$ ; unless otherwise noted

| Parameter                                       | Symbol                   | Conditions   | Min  | Typ <sup>1</sup> | Max        | Unit                         |
|---|--------------------------|--|------|------------------|------------|------------------------------|
| <b>DC CHARACTERISTICS—RHEOSTAT MODE</b>         |                          |  |      |                  |            |                              |
| Resistor Differential Nonlinearity <sup>2</sup> | R-DNL                    | $R_{WB}$   | -1.5 | $\pm 0.1$        | +1.5       | LSB                          |
| Resistor Integral Nonlinearity <sup>2</sup>     | R-INL                    | $R_{WB}$   | -4   | $\pm 0.75$       | +4         | LSB                          |
| Nominal Resistor Tolerance <sup>3</sup>         | $\Delta R_{AB}$          | $T_A = 25^\circ\text{C}$   | -30  |                  | +30        | %                            |
| Resistance Temperature Coefficient              | $\Delta R_{AB}/\Delta T$ | Wiper = No Connect   |      | 45               |            | ppm/ $^\circ\text{C}$        |
| $R_{WB}$  | $R_{WB}$                 | Code=0x00, $V_{DD} = 5\text{ V}$                                       |      | 75               | 150        | $\Omega$                     |
|   |                          | Code=0x00, $V_{DD} = 2.7\text{ V}$                                     |      | 150              | 400        | $\Omega$                     |
| <b>RESISTOR TERMINALS</b>                       |                          |  |      |                  |            |                              |
| Voltage Range <sup>4</sup>                      | $V_{B,W}$                |  | GND  |                  | $V_{DD}$   | V                            |
| Capacitance <sup>5</sup> B                      | $C_B$                    | $f = 1\text{ MHz}$ , Measured to GND, Code = 0x40                      |      | 45               |            | pF                           |
| Capacitance <sup>5</sup> W                      | $C_W$                    | $f = 1\text{ MHz}$ , Measured to GND, Code = 0x40                      |      | 60               |            | pF                           |
| Common-Mode Leakage                             | $I_{CM}$                 |  |      | 1                |            | nA                           |
| <b>DIGITAL INPUTS AND OUTPUTS</b>               |                          |  |      |                  |            |                              |
| Input Logic High                                | $V_{IH}$                 | $V_{DD} = 5\text{ V}$  | 2.4  |                  |            | V                            |
| Input Logic Low                                 | $V_{IL}$                 | $V_{DD} = 5\text{ V}$  |      |                  | 0.8        | V                            |
| Input Logic High                                | $V_{IH}$                 | $V_{DD} = 3\text{ V}$  | 2.1  |                  |            | V                            |
| Input Logic Low                                 | $V_{IL}$                 | $V_{DD} = 3\text{ V}$  |      |                  | 0.6        | V                            |
| Input Current                                   | $I_{IL}$                 | $V_{IN} = 0\text{ V}$ or $5\text{ V}$                                  |      |                  | $\pm 1$    | $\mu\text{A}$                |
| Input Capacitance <sup>5</sup>                  | $C_{IL}$                 |  |      | 5                |            | pF                           |
| <b>POWER SUPPLIES</b>                           |                          |  |      |                  |            |                              |
| Power Supply Range                              | $V_{DD\text{ RANGE}}$    |  | 2.7  |                  | 5.5        | V                            |
| Supply Current                                  | $I_{DD}$                 | $V_{IH} = 5\text{ V}$ or $V_{IL} = 0\text{ V}$                         |      | 3                | 8          | $\mu\text{A}$                |
| Power Dissipation <sup>6</sup>                  | $P_{DISS}$               | $V_{IH} = 5\text{ V}$ or $V_{IL} = 0\text{ V}$ , $V_{DD} = 5\text{ V}$ |      |                  | 40         | $\mu\text{W}$                |
| Power Supply Sensitivity                        | PSSR                     | $V_{DD} = +5\text{ V} \pm 10\%$ , Code = Midscale                      |      | $\pm 0.01$       | $\pm 0.02$ | %/%                          |
| <b>DYNAMIC CHARACTERISTICS<sup>5,7</sup></b>    |                          |  |      |                  |            |                              |
| Bandwidth -3 dB                                 | BW_5K                    | $R_{AB} = 5\text{ k}\Omega$ , Code = 0x40                              |      | 1.2              |            | MHz                          |
| Total Harmonic Distortion                       | THD <sub>W</sub>         | $V_A = 1\text{ V rms}$ , $V_B = 0\text{ V}$ , $f = 1\text{ kHz}$       |      | 0.05             |            | %                            |
| $V_W$ Settling Time                             | $t_s$                    | $V_A = 5\text{ V}$ , $\pm 1\text{ LSB}$ Error Band                     |      | 1                |            | $\mu\text{s}$                |
| Resistor Noise Voltage Density                  | e <sub>N_WB</sub>        | $R_{WB} = 2.5\text{ k}\Omega$ , $R_S = 0\text{ }\Omega$                |      | 6                |            | $\text{nV}/\sqrt{\text{Hz}}$ |

<sup>1</sup> Typical specifications represent average readings at  $25^\circ\text{C}$  and  $V_{DD} = 5\text{ V}$ .

<sup>2</sup> Resistor position nonlinearity error R-INL is the deviation from an ideal value measured between the maximum resistance and the minimum resistance wiper positions. R-DNL measures the relative step change from ideal between successive tap positions. Parts are guaranteed monotonic.

<sup>3</sup> Code = 0x7F.

<sup>4</sup> Resistor terminals A and W have no limitations on polarity with respect to each other.

<sup>5</sup> Guaranteed by design and not subject to production test.

<sup>6</sup>  $P_{DISS}$  is calculated from  $(I_{DD} \times V_{DD})$ . CMOS logic level inputs result in minimum power dissipation.

<sup>7</sup> All dynamic characteristics use  $V_{DD} = 5\text{ V}$ .

ELECTRICAL CHARACTERISTICS—10 k $\Omega$ , 50 k $\Omega$ , 100 k $\Omega$  VERSIONSTable 2.  $V_{DD} = 5\text{ V} \pm 10\%$  or  $3\text{ V} \pm 10\%$ ;  $V_A = V_{DD}$ ;  $-40^\circ\text{C} < T_A < +125^\circ\text{C}$ ; unless otherwise noted

| Parameter   | Symbol                   | Conditions  | Min | Typ <sup>1</sup> | Max        | Unit                   |
|---|--------------------------|---|-----|------------------|------------|------------------------|
| DC CHARACTERISTICS—RHEOSTAT MODE                                    |                          |   |     |                  |            |                        |
| Resistor Differential Nonlinearity <sup>2</sup>                     | R-DNL                    | $R_{WB}, V_A = \text{No Connect}$   | -1  | $\pm 0.1$        | +1         | LSB                    |
| Resistor Integral Nonlinearity <sup>2</sup>                         | R-INL                    | $R_{WB}, V_A = \text{No Connect}$   | -2  | $\pm 0.25$       | +2         | LSB                    |
| Nominal Resistor Tolerance <sup>3</sup>                             | $\Delta R_{AB}$          | $T_A = 25^\circ\text{C}$  | -20 |                  | +20        | %                      |
| Resistance Temperature Coefficient                                  | $\Delta R_{AB}/\Delta T$ | Wiper = No Connect  |     | 45               |            | ppm/ $^\circ\text{C}$  |
| $R_{WB}$  | $R_{WB}$                 | Code=0x00, $V_{DD} = 5\text{ V}$  |     | 75               | 150        | $\Omega$               |
|   |                          | Code=0x00, $V_{DD} = 2.7\text{ V}$  |     | 150              | 400        | $\Omega$               |
| RESISTOR TERMINALS  |                          |   |     |                  |            |                        |
| Voltage Range <sup>4</sup>  | $V_{B,W}$                |   | GND |                  | $V_{DD}$   | V                      |
| Capacitance <sup>5</sup> B  | $C_B$                    | $f = 1\text{ MHz}$ , Measured to GND, Code = 0x40                               |     | 45               |            | pF                     |
| Capacitance <sup>5</sup> W  | $C_W$                    | $f = 1\text{ MHz}$ , measured to GND, Code = 0x40                               |     | 60               |            | pF                     |
| Common-Mode Leakage   | $I_{CM}$                 |   |     | 1                |            | nA                     |
| DIGITAL INPUTS AND OUTPUTS  |                          |   |     |                  |            |                        |
| Input Logic High  | $V_{IH}$                 | $V_{DD} = 5\text{ V}$   | 2.4 |                  |            | V                      |
| Input Logic Low   | $V_{IL}$                 | $V_{DD} = 5\text{ V}$   |     |                  | 0.8        | V                      |
| Input Logic High  | $V_{IH}$                 | $V_{DD} = 3\text{ V}$   | 2.1 |                  |            | V                      |
| Input Logic Low   | $V_{IL}$                 | $V_{DD} = 3\text{ V}$   |     |                  | 0.6        | V                      |
| Input Current   | $I_{IL}$                 | $V_{IN} = 0\text{ V}$ or $5\text{ V}$   |     |                  | $\pm 1$    | $\mu\text{A}$          |
| Input Capacitance <sup>5</sup>                                      | $C_{IL}$                 |   |     | 5                |            | pF                     |
| POWER SUPPLIES  |                          |   |     |                  |            |                        |
| Power Supply Range  | $V_{DD\text{ RANGE}}$    |   | 2.7 |                  | 5.5        | V                      |
| Supply Current  | $I_{DD}$                 | $V_{IH} = 5\text{ V}$ or $V_{IL} = 0\text{ V}$                                  |     | 3                | 8          | $\mu\text{A}$          |
| Power Dissipation <sup>6</sup>                                      | $P_{DISS}$               | $V_{IH} = 5\text{ V}$ or $V_{IL} = 0\text{ V}$ , $V_{DD} = 5\text{ V}$          |     |                  | 40         | $\mu\text{W}$          |
| Power Supply Sensitivity  | PSSR                     | $V_{DD} = +5\text{ V} \pm 10\%$ , Code = Midscale                               |     | $\pm 0.01$       | $\pm 0.02$ | %/%                    |
| DYNAMIC CHARACTERISTICS <sup>5,7</sup>                              |                          |   |     |                  |            |                        |
| Bandwidth -3 dB   | BW                       | $R_{AB} = 10\text{ k}\Omega/50\text{ k}\Omega/100\text{ k}\Omega$ , Code = 0x40 |     | 600/100/40       |            | kHz                    |
| Total Harmonic Distortion   | THD <sub>W</sub>         | $V_A = 1\text{ V rms}$ , $f = 1\text{ kHz}$ , $R_{AB} = 10\text{ k}\Omega$      |     | 0.05             |            | %                      |
| $V_W$ Settling Time (10 k $\Omega$ /50 k $\Omega$ /100 k $\Omega$ ) | $t_s$                    | $V_A = 5\text{ V} \pm 1\text{ LSB Error Band}$                                  |     | 2                |            | $\mu\text{s}$          |
| Resistor Noise Voltage Density                                      | $e_{N\_WB}$              | $R_{WB} = 5\text{ k}\Omega$ , $R_S = 0$   |     | 9                |            | nV/ $\sqrt{\text{Hz}}$ |

<sup>1</sup> Typical specifications represent average readings at  $+25^\circ\text{C}$  and  $V_{DD} = 5\text{ V}$ .<sup>2</sup> Resistor position nonlinearity error R-INL is the deviation from an ideal value measured between the maximum resistance and the minimum resistance wiper positions. R-DNL measures the relative step change from ideal between successive tap positions. Parts are guaranteed monotonic.<sup>3</sup> Code = 0x7F.<sup>4</sup> Resistor terminals A and W have no limitations on polarity with respect to each other.<sup>5</sup> Guaranteed by design and not subject to production test.<sup>6</sup>  $P_{DISS}$  is calculated from ( $I_{DD} \times V_{DD}$ ). CMOS logic level inputs result in minimum power dissipation.<sup>7</sup> All dynamic characteristics use  $V_{DD} = 5\text{ V}$ .

## TIMING CHARACTERISTICS—5 k $\Omega$ , 10 k $\Omega$ , 50 k $\Omega$ , 100 k $\Omega$ VERSIONS

Table 3.  $V_{DD} = 5\text{ V} \pm 10\%$  or  $3\text{ V} \pm 10\%$ ;  $V_A = V_{DD}$ ;  $-40^\circ\text{C} < T_A < +125^\circ\text{C}$ ; unless otherwise noted

| Parameter  | Symbol    | Conditions   | Min | Typ <sup>1</sup> | Max           | Unit          |
|--|-----------|--|-----|------------------|---------------|---------------|
| <b>I<sup>2</sup>C INTERFACE TIMING CHARACTERISTICS<sup>2,3</sup></b> |           |  |     |                  |               |               |
| (Specifications Apply to All Parts)                                  |           |  |     |                  |               |               |
| SCL Clock Frequency  | $f_{SCL}$ | After this period, the first clock pulse is generated. |     |                  | 400           | kHz           |
| $t_{BUF}$ Bus Free Time between STOP and START                       | $t_1$     |  | 1.3 |                  |               | $\mu\text{s}$ |
| $t_{HD,STA}$ Hold Time (Repeated START)                              | $t_2$     |  | 0.6 |                  |               | $\mu\text{s}$ |
| $t_{LOW}$ Low Period of SCL Clock                                    | $t_3$     |  | 1.3 |                  |               | $\mu\text{s}$ |
| $t_{HIGH}$ High Period of SCL Clock                                  | $t_4$     |  | 0.6 |                  | 50            | $\mu\text{s}$ |
| $t_{SU,STA}$ Setup Time for Repeated START Condition                 | $t_5$     |  | 0.6 |                  |               | $\mu\text{s}$ |
| $t_{HD,DAT}$ Data Hold Time  | $t_6$     |  |     |                  | 0.9           | $\mu\text{s}$ |
| $t_{SU,DAT}$ Data Setup Time   | $t_7$     |  | 100 |                  |               | ns            |
| $t_F$ Fall Time of Both SDA and SCL Signals                          | $t_8$     |  |     |                  | 300           | ns            |
| $t_R$ Rise Time of Both SDA and SCL Signals                          | $t_9$     |  |     |                  | 300           | ns            |
| $t_{SU,STO}$ Setup Time for STOP Condition                           | $t_{10}$  |  |     | 0.6              | $\mu\text{s}$ |               |

<sup>1</sup> Typical specifications represent average readings at 25°C and  $V_{DD} = 5\text{ V}$ .

<sup>2</sup> Guaranteed by design and not subject to production test.

<sup>3</sup> See timing diagrams (Figure 25, Figure 26, Figure 27) for locations of measured values.

## ABSOLUTE MAXIMUM RATINGS

Table 4.  $T_A = 25^\circ\text{C}$ , unless otherwise noted<sup>1</sup>

| Parameter  | Value                                       |
|--|---|
| $V_{DD}$ to GND  | -0.3 V to +7 V                              |
| $V_A$ , $V_W$ to GND                                   | $V_{DD}$                                    |
| Terminal Current, Ax-Bx, Ax-Wx, Bx-Wx                  |   |
| Pulsed <sup>2</sup>                                    | $\pm 20$ mA                                 |
| Continuous   | $\pm 5$ mA                                  |
| Digital Inputs and Output Voltage to GND               | 0 V to $V_{DD} + 0.3$ V                     |
| Operating Temperature Range                            | $-40^\circ\text{C}$ to $+125^\circ\text{C}$ |
| Maximum Junction Temperature ( $T_{JMAX}$ )            | $150^\circ\text{C}$                         |
| Storage Temperature                                    | $-65^\circ\text{C}$ to $+150^\circ\text{C}$ |
| Lead Temperature (Soldering, 10 sec)                   | $300^\circ\text{C}$                         |
| Thermal Resistance <sup>3</sup> $\theta_{JA}$ : SC70-6 | $340^\circ\text{C/W}$                       |

<sup>1</sup> Stresses above those listed under Absolute Maximum Ratings may cause permanent damage to the device. This is a stress rating only; functional operation of the device at these or any other conditions above those indicated in the operational section of this specification is not implied. Exposure to absolute maximum rating conditions for extended periods may affect device reliability.

<sup>2</sup> Maximum terminal current is bounded by the maximum current handling of the switches, maximum power dissipation of the package, and maximum applied voltage across any two of the A, B, and W terminals at a given resistance.

<sup>3</sup> Package power dissipation =  $(T_{JMAX} - T_A)/\theta_{JA}$ .

## ESD CAUTION

ESD (electrostatic discharge) sensitive device. Electrostatic charges as high as 4000 V readily accumulate on the human body and test equipment and can discharge without detection. Although this product features proprietary ESD protection circuitry, permanent damage may occur on devices subjected to high energy electrostatic discharges. Therefore, proper ESD precautions are recommended to avoid performance degradation or loss of functionality.



# TYPICAL PERFORMANCE CHARACTERISTICS

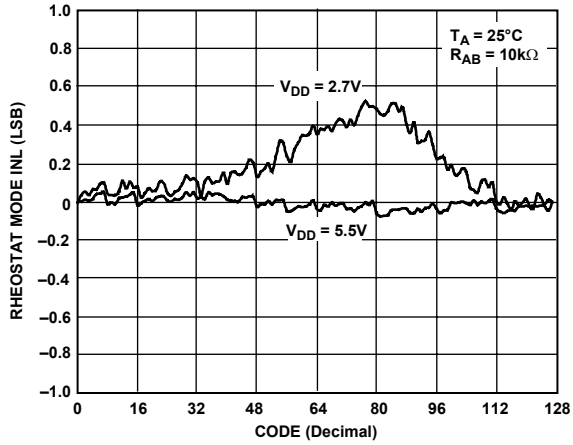

Figure 2. R-INL vs. Code vs. Supply Voltages

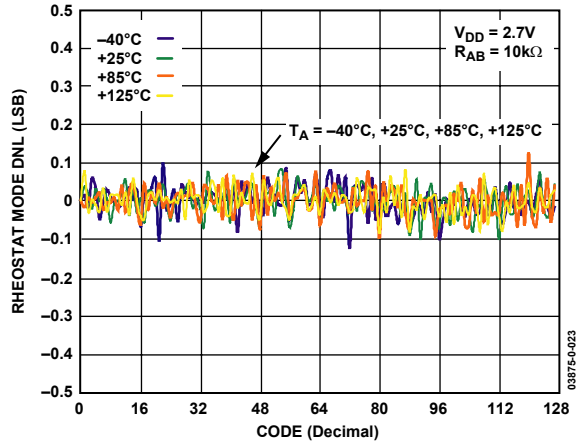

Figure 5. R-DNL vs. Code vs. Temperature

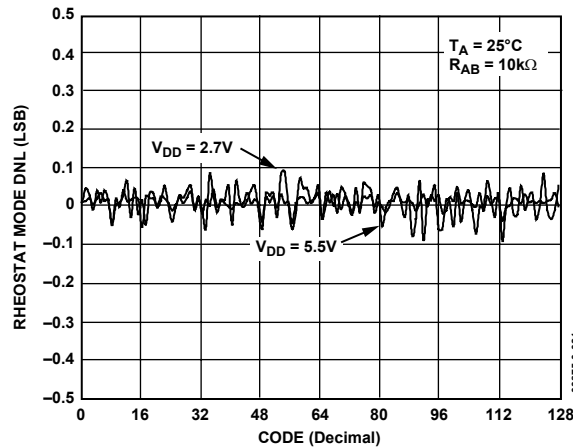

Figure 3. R-DNL vs. Code vs. Supply Voltages

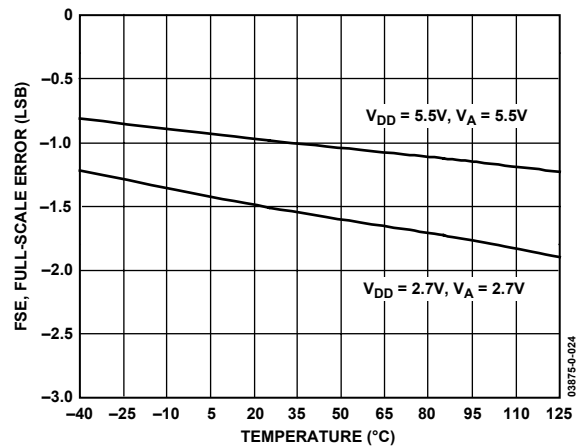

Figure 6. Full-Scale Error vs. Temperature

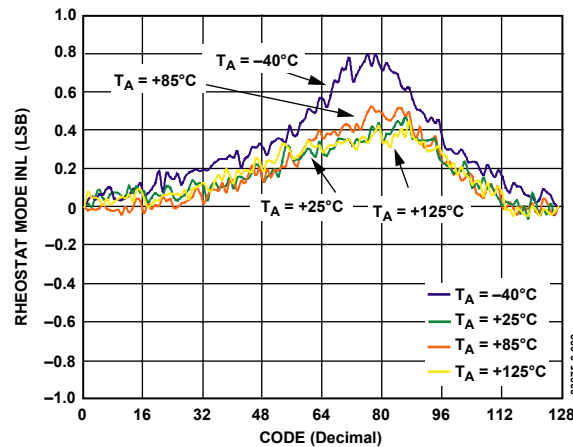

Figure 4. R-INL vs. Code vs. Temperature

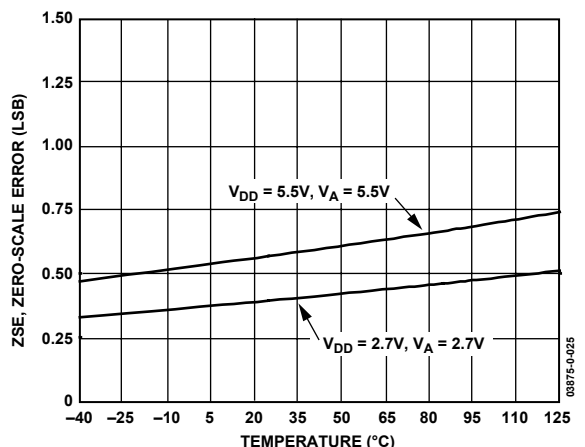

Figure 7. Zero-Scale Error vs. Temperature

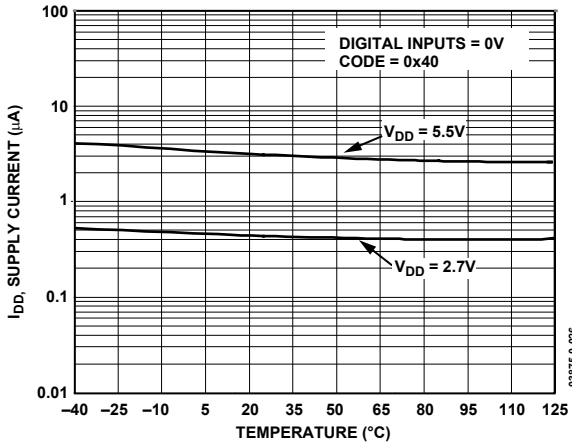

Figure 8. Supply Current vs. Temperature

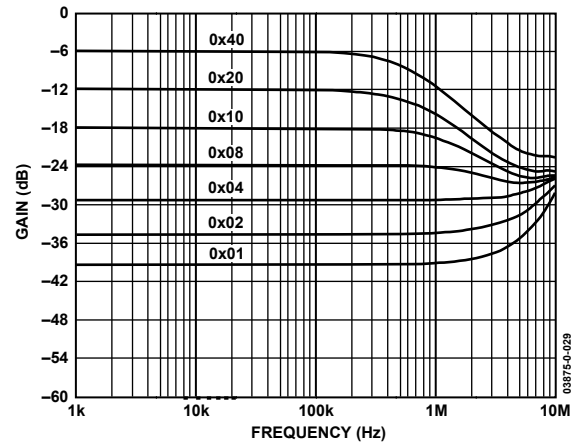

Figure 11. Gain vs. Frequency vs. Code,  $R_{AB} = 10\text{ k}\Omega$

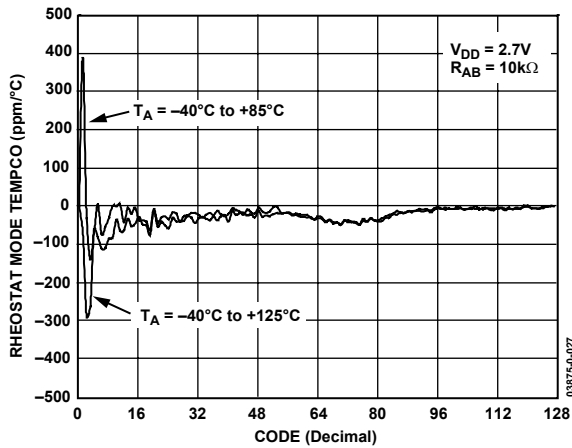

Figure 9. Rheostat Mode Tempco  $\Delta R_{WB}/\Delta T$  vs. Code

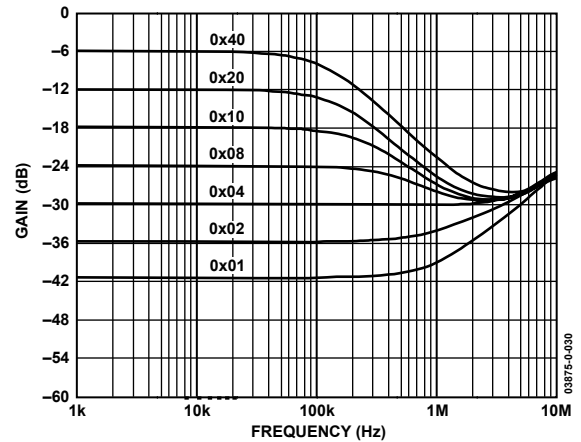

Figure 12. Gain vs. Frequency vs. Code,  $R_{AB} = 50\text{ k}\Omega$

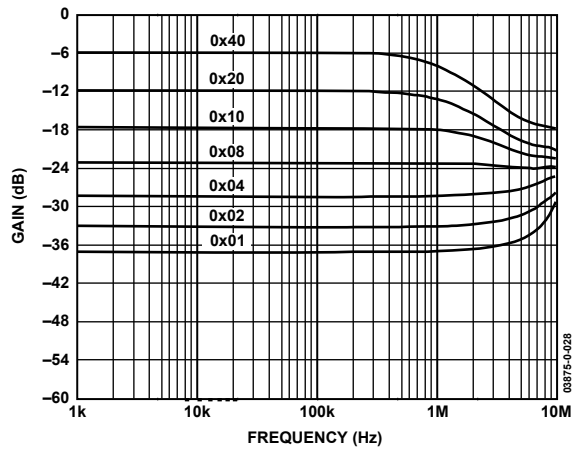

Figure 10. Gain vs. Frequency vs. Code,  $R_{AB} = 5\text{ k}\Omega$

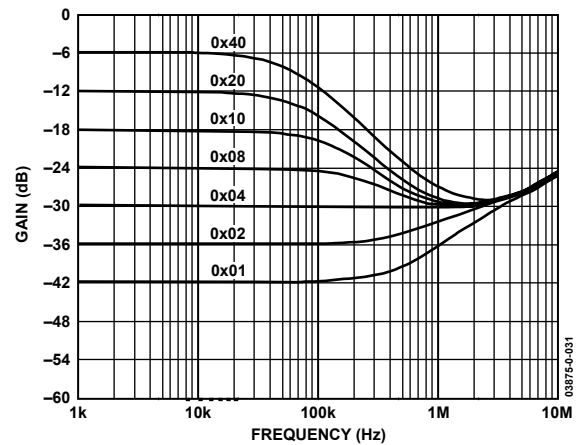

Figure 13. Gain vs. Frequency vs. Code,  $R_{AB} = 100\text{ k}\Omega$



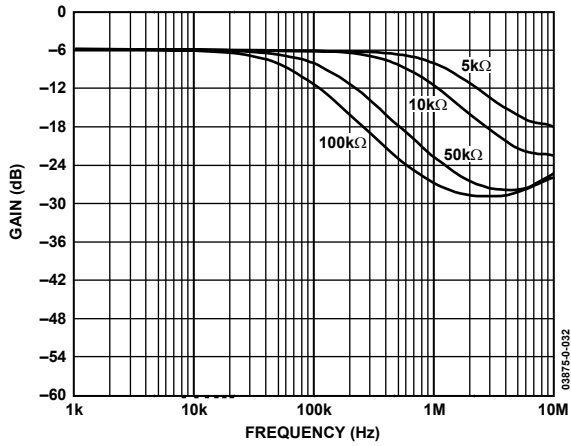

Figure 14. -3 dB Bandwidth @ Code = 0x80

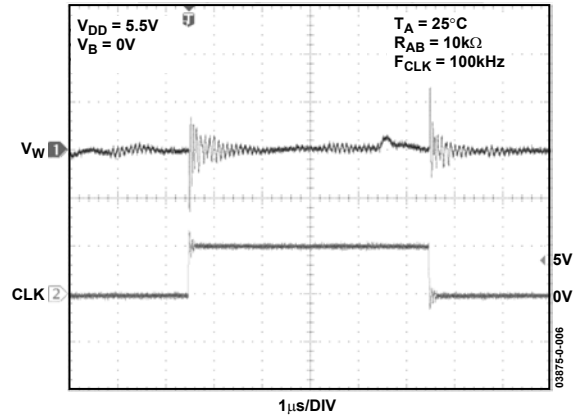

Figure 17. Digital Feedthrough

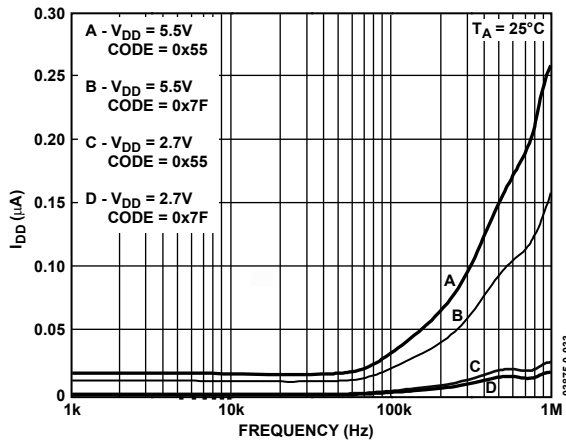

Figure 15.  $I_{DD}$  vs. Frequency

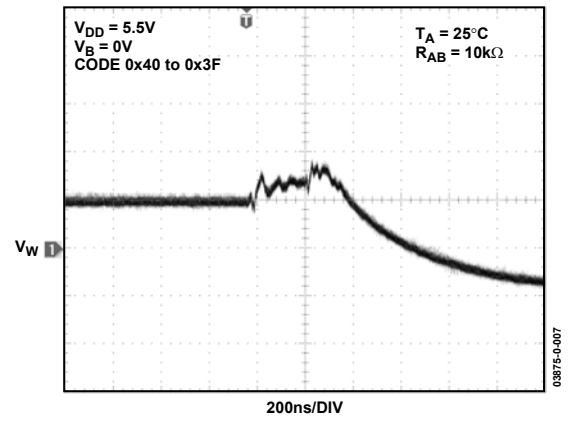

Figure 18. Midscale Glitch, Code 0x40 to 0x3F

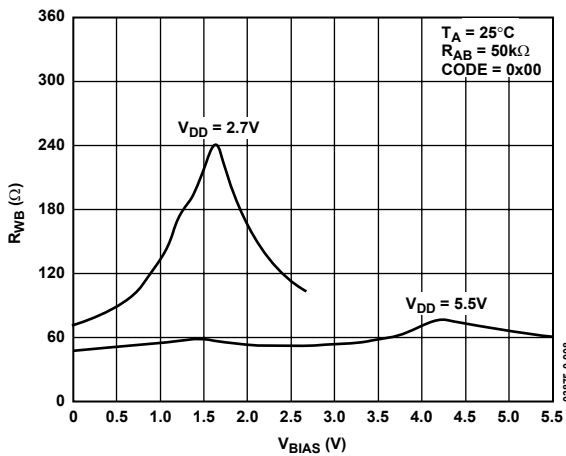

Figure 16.  $R_{WB}$  vs.  $V_{BIAS}$  vs.  $V_{DD}$

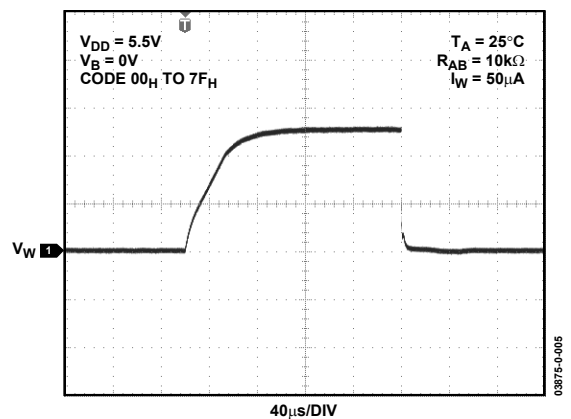

Figure 19. Large Signal Settling Time

TEST CIRCUITS

Figure 20 to Figure 24 define the test conditions used in the product Specification tables.

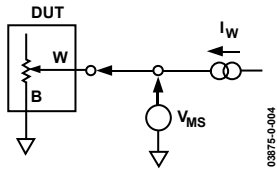

Figure 20. Test Circuit for Resistor Position Nonlinearity Error (Rheostat Operation; R-INL, R-DNL)

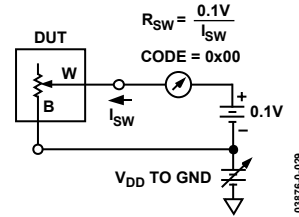

Figure 23. Test Circuit for Incremental ON Resistance

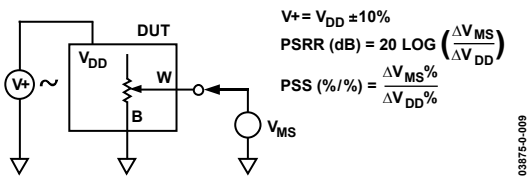

Figure 21. Test Circuit for Power Supply Sensitivity (PSS, PSSR)

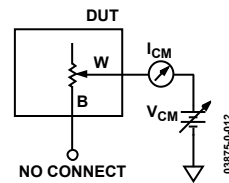

Figure 24. Test Circuit for Common-Mode Leakage Current

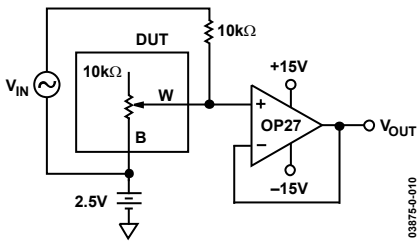

Figure 22. Test Circuit for Gain vs. Frequency

# I<sup>2</sup>C INTERFACE

Table 5. Write Mode

|                    |   |   |   |   |   |   |   |           |   |           |    |    |    |    |    |    |    |   |   |
|--------------------|---|---|---|---|---|---|---|-----------|---|-----------|----|----|----|----|----|----|----|---|---|
| S                  | 0 | 1 | 0 | 1 | 1 | 1 | 0 | $\bar{W}$ | A | X         | D6 | D5 | D4 | D3 | D2 | D1 | D0 | A | P |
| Slave Address Byte |   |   |   |   |   |   |   |           |   | Data Byte |    |    |    |    |    |    |    |   |   |

Table 6. Read Mode

|                    |   |   |   |   |   |   |   |   |   |           |    |    |    |    |    |    |    |   |   |
|--------------------|---|---|---|---|---|---|---|---|---|-----------|----|----|----|----|----|----|----|---|---|
| S                  | 0 | 1 | 0 | 1 | 1 | 1 | 0 | R | A | 0         | D6 | D5 | D4 | D3 | D2 | D1 | D0 | A | P |
| Slave Address Byte |   |   |   |   |   |   |   |   |   | Data Byte |    |    |    |    |    |    |    |   |   |

S = Start Condition.

$\bar{W}$  = Write.

P = Stop Condition.

R = Read.

A = Acknowledge.

D6, D5, D4, D3, D2, D1, D0 = Data Bits.

X = Don't Care.

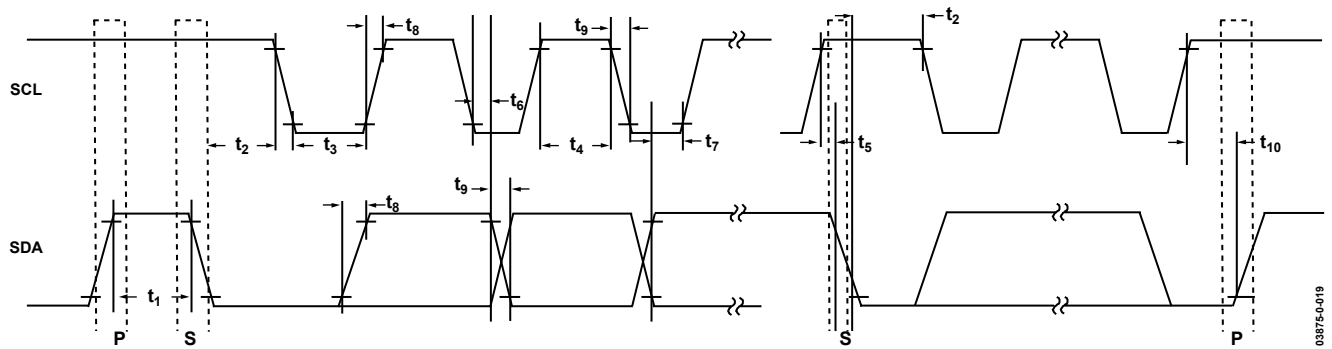

Figure 25. I<sup>2</sup>C Interface, Detailed Timing Diagram

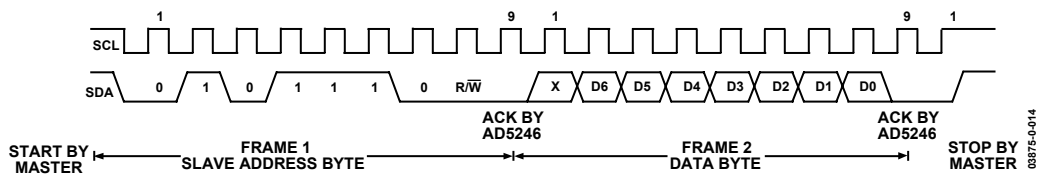

Figure 26. Writing to the RDAC Register

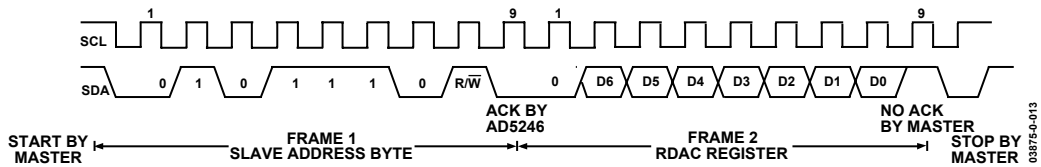

Figure 27. Reading from the RDAC Register

## OPERATION

The AD5246 is a 128-position, digitally controlled variable resistor (VR) device. An internal power-on preset places the wiper at midscale during power-on, which simplifies the default condition recovery at power-up.

### PROGRAMMING THE VARIABLE RESISTOR

#### Rheostat Operation

The nominal resistance of the RDAC between terminals A and B is available in 5 kΩ, 10 kΩ, 50 kΩ, and 100 kΩ. The final two or three digits of the part number determine the nominal resistance value, e.g., 10 kΩ = 10, 50 kΩ = 50. The nominal resistance ( $R_{AB}$ ) of the VR has 128 contact points accessed by the wiper terminal, plus the B terminal contact. The 7-bit data in the RDAC latch is decoded to select one of the 128 possible settings.

Assuming a 10 kΩ part is used, the wiper's first connection starts at the B terminal for data 0x00. Since there is a 50 Ω wiper contact resistance, such a connection yields a minimum of 100 Ω ( $2 \times 50 \Omega$ ) resistance between terminals W and B. The second connection is the first tap point, which corresponds to 178 Ω ( $R_{WB} = R_{AB}/128 + R_W = 78 \Omega + 2 \times 50 \Omega$ ) for data 0x01. The third connection is the next tap point, representing 256 Ω ( $2 \times 78 \Omega + 2 \times 50 \Omega$ ) for data 0x02, and so on. Each LSB data value increase moves the wiper up the resistor ladder until the last tap point is reached at 10,100 Ω ( $R_{AB} + 2 \times R_W$ ).

Figure 28 shows a simplified diagram of the equivalent RDAC circuit.

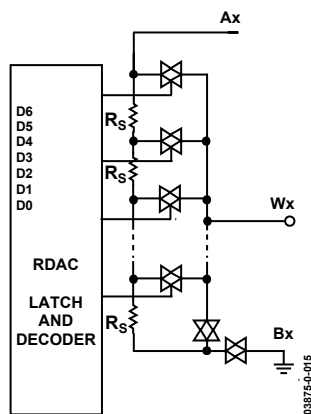

Figure 28. AD5246 Equivalent RDAC Circuit

The general equation determining the digitally programmed output resistance between W and B is

$$R_{WB}(D) = \frac{D}{128} \times R_{AB} + 2 \times R_W \quad (1)$$

where  $D$  is the decimal equivalent of the binary code loaded in the 7-bit RDAC register,  $R_{AB}$  is the end-to-end resistance, and  $R_W$  is the wiper resistance contributed by the on resistance of the internal switch. In summary, if  $R_{AB} = 10 \text{ k}\Omega$  and the A terminal is open-circuited, the output resistance  $R_{WB}$  shown in Table 7 will be set for the indicated RDAC latch codes.

Table 7. Codes and Corresponding  $R_{WB}$  Resistance

| D (Dec.) | $R_{WB}$ (Ω) | Output State                           |
|----------|--------------|--|
| 127      | 10,100       | Full Scale ( $R_{AB} + 2 \times R_W$ ) |
| 64       | 5,100        | Midscale                               |
| 1        | 178          | 1 LSB                                  |
| 0        | 100          | Zero Scale (Wiper Contact Resistance)  |

Note that in the zero-scale condition, a finite wiper resistance of 100 Ω is present. Care should be taken to limit the current flow between W and B in this state to a maximum pulse current of no more than 20 mA. Otherwise, degradation or possible destruction of the internal switch contact can occur.

Typical device-to-device matching is process lot dependent and may vary by up to ±30%. Since the resistance element is processed in thin film technology, the change in  $R_{AB}$  with temperature has a very low 45 ppm/°C temperature coefficient.

## I<sup>2</sup>C COMPATIBLE 2-WIRE SERIAL BUS

The first byte of the AD5246 is a slave address byte (see Table 5 and Table 6). It has a 7-bit slave address and a R/W bit. The seven MSBs of the slave address are 0101110 followed by 0 for a write command or 1 to place the device in read mode.

The 2-wire I<sup>2</sup>C serial bus protocol operates as follows:

1. The master initiates data transfer by establishing a START condition, which is when a high-to-low transition on the SDA line occurs while SCL is high (see Figure 26). The following byte is the slave address byte, which consists of the 7-bit slave address followed by an R/W bit (this bit determines whether data will be read from or written to the slave device).  
  
The slave whose address corresponds to the transmitted address responds by pulling the SDA line low during the ninth clock pulse (this is termed the acknowledge bit). At this stage, all other devices on the bus remain idle while the selected device waits for data to be written to or read from its serial register. If the R/W bit is high, the master will read from the slave device. On the other hand, if the R/W bit is low, the master will write to the slave device.
2. In write mode, after acknowledgement of the slave address byte, the next byte is the data byte. Data is transmitted over the serial bus in sequences of nine clock pulses (eight data bits followed by an acknowledge bit). The transitions on the SDA line must occur during the low period of SCL and remain stable during the high period of SCL (see Table 5).
3. In read mode, after acknowledgement of the slave address byte, data is received over the serial bus in sequences of nine clock pulses (a slight difference from the write mode where eight data bits are followed by an acknowledge bit). Similarly, the transitions on the SDA line must occur during the low period of SCL and remain stable during the high period of SCL (see Figure 27).
4. When all data bits have been read or written, a STOP condition is established by the master. A STOP condition is defined as a low-to-high transition on the SDA line while SCL is high. In write mode, the master will pull the SDA line high during the tenth clock pulse to establish a STOP condition (see Figure 26). In read mode, the master will issue a No Acknowledge for the ninth clock pulse (i.e., the SDA line remains high). The master will then bring the SDA line low before the tenth clock pulse, which goes high to establish a STOP condition (see Figure 27).

A repeated write function gives the user flexibility to update the RDAC output a number of times after addressing the part only once. For example, after the RDAC has acknowledged its slave address in write mode, the RDAC output will update on each successive byte. If different instructions are needed, write/read mode has to start again with a new slave address and data byte. Similarly, a repeated read function of the RDAC is also allowed.

## LEVEL SHIFTING FOR BIDIRECTIONAL INTERFACE

While most legacy systems may be operated at one voltage, a new component may be optimized at another. When two systems operate the same signal at two different voltages, proper level shifting is needed. For instance, one can use a 3.3 V E<sup>2</sup>PROM to interface with a 5 V digital potentiometer. A level shifting scheme is needed to enable a bidirectional communication so that the setting of the digital potentiometer can be stored to and retrieved from the E<sup>2</sup>PROM. Figure 29 shows one of the implementations. M1 and M2 can be any N channel signal FETs, or if V<sub>DD</sub> falls below 2.5 V, M1 and M2 can be low threshold FETs such as the FDV301N.

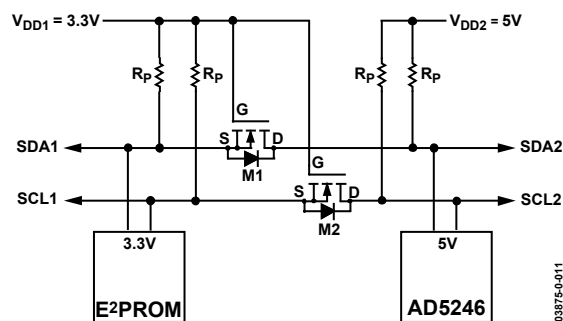

Figure 29. Level Shifting for Operation at Different Potentials

## ESD PROTECTION

All digital inputs are protected with a series input resistor and parallel Zener ESD structures shown in Figure 30 and Figure 31. This applies to the digital input pins SDA and SCL.

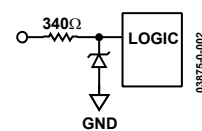

Figure 30. ESD Protection of Digital Pins

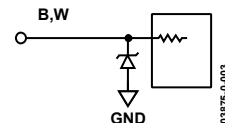

Figure 31. ESD Protection of Resistor Terminals

## TERMINAL VOLTAGE OPERATING RANGE

The AD5246  $V_{DD}$  and GND power supply defines the boundary conditions for proper 3-terminal digital potentiometer operation. Supply signals present on terminals B and W that exceed  $V_{DD}$  or GND will be clamped by the internal forward biased diodes (see Figure 32).

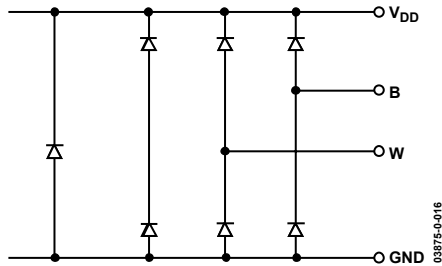

Figure 32. Maximum Terminal Voltages Set by  $V_{DD}$  and GND

## MAXIMUM OPERATING CURRENT

At low code values, the user should be aware that due to low resistance values, the current through the RDAC may exceed the 5 mA limit. In Figure 33, a 5 V supply is placed on the wiper, and the current through terminals W and B is plotted with respect to code. A line is also drawn denoting the 5 mA current limit. Note that at low code values (particularly for the 5 k $\Omega$  and 10 k $\Omega$  options), the current level increases significantly. Care should be taken to limit the current flow between W and B in this state to a maximum continuous current of 5 mA and a maximum pulse current of no more than 20 mA. Otherwise, degradation or possible destruction of the internal switch contacts can occur.

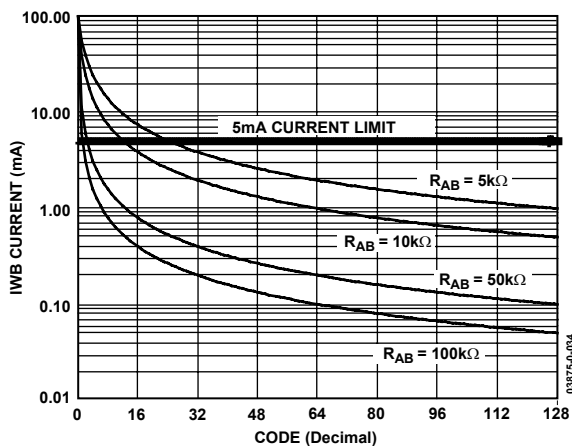

Figure 33. Maximum Operating Current

## POWER-UP SEQUENCE

Since the ESD protection diodes limit the voltage compliance at terminals B and W (see Figure 32), it is important to power  $V_{DD}$ /GND before applying any voltage to terminals B and W; otherwise, the diode will be forward biased such that  $V_{DD}$  will be powered unintentionally and may affect the rest of the user's circuit. The ideal power-up sequence is in the following order: GND,  $V_{DD}$ , digital inputs, and then  $V_B/V_W$ . The relative order of powering  $V_B$  and  $V_W$  and the digital inputs is not important as long as they are powered after  $V_{DD}$ /GND.

## LAYOUT AND POWER SUPPLY BYPASSING

It is a good practice to employ a compact, minimum lead-length layout design. The leads to the inputs should be as direct as possible with a minimum conductor length. Ground paths should have low resistance and low inductance.

Similarly, it is a good practice to bypass the power supplies with quality capacitors for optimum stability. Supply leads to the device should be bypassed with 0.01  $\mu$ F to 0.1  $\mu$ F disc or chip ceramic capacitors. Low ESR 1  $\mu$ F to 10  $\mu$ F tantalum or electrolytic capacitors should also be applied at the supplies to minimize any transient disturbance and low frequency ripple (see Figure 34). Note that the digital ground should also be joined remotely to the analog ground at one point to minimize the ground bounce.

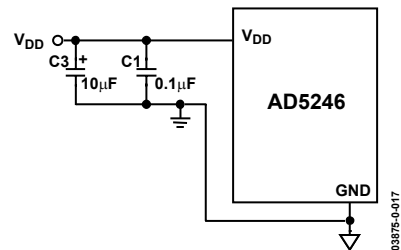

Figure 34. Power Supply Bypassing

## CONSTANT BIAS TO RETAIN RESISTANCE SETTING

For users who desire nonvolatility but cannot justify the additional cost for the EEMEM, the AD5246 may be considered as a low cost alternative by maintaining a constant bias to retain the wiper setting. The AD5246 was designed specifically with low power in mind, which allows low power consumption even in battery-operated systems. The graph in Figure 35 demonstrates the power consumption from a 3.4 V 450 mAh Li-ion cell phone battery, which is connected to the AD5246. The measurement over time shows that the device draws approximately 1.3  $\mu$ A and consumes negligible power. Over a course of 30 days, the battery was depleted by less than 2%, the majority of which is due to the intrinsic leakage current of the battery itself.

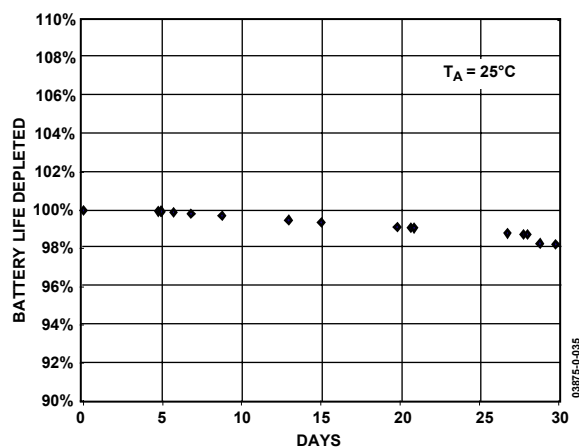

Figure 35. Battery Operating Life Depletion

This demonstrates that constantly biasing the pot is not an impractical approach. Most portable devices do not require the removal of batteries for the purpose of charging. Although the resistance setting of the AD5246 will be lost when the battery needs replacement, such events occur rather infrequently such that this inconvenience is justified by the lower cost and smaller size offered by the AD5246. If and when total power is lost, the user should be provided with a means to adjust the setting accordingly.

## EVALUATION BOARD

An evaluation board, along with all necessary software, is available to program the AD5246 from any PC running Windows® 98, Windows 2000, or Windows XP®. The graphical user interface, as shown in Figure 36 is straightforward and easy to use. More detailed information is available in the user manual, which comes with the board.

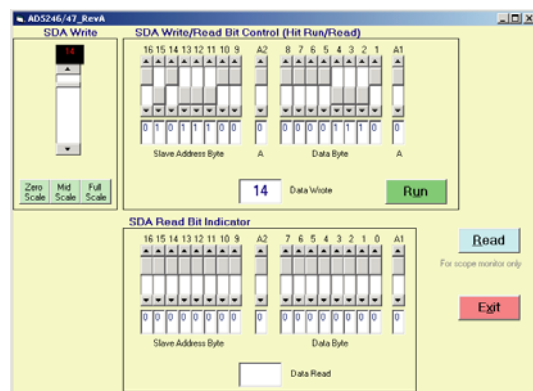

Figure 36. AD5246 Evaluation Board Software

# AD5246

## PIN CONFIGURATION AND FUNCTION DESCRIPTIONS

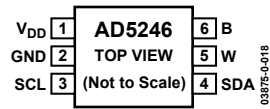

Figure 37. Pin Function Descriptions, 6-Lead SC70

Table 8. AD5246 Pin Function Descriptions

| Pin No. | Mnemonic        | Description                                  |
|---------|-----------------|--|
| 1       | V <sub>DD</sub> | Positive Power Supply.                       |
| 2       | GND             | Digital Ground.                              |
| 3       | SCL             | Serial Clock Input. Positive edge triggered. |
| 4       | SDA             | Serial Data Input/Output.                    |
| 5       | W               | W Terminal.                                  |
| 6       | B               | B Terminal.                                  |



# OUTLINE DIMENSIONS

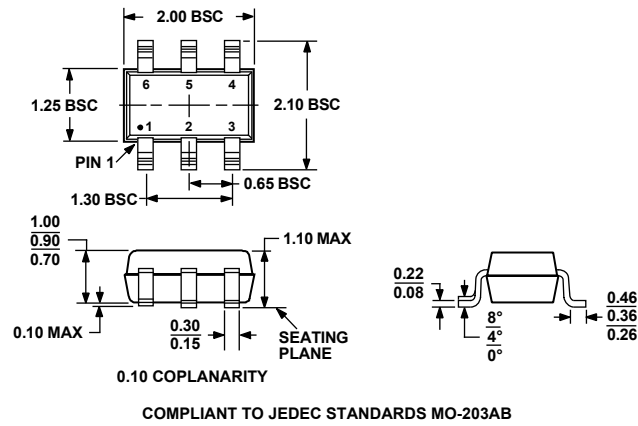

Figure 38. 6-Lead Thin Shrink Small Outline Transistor [SC70]  
(KS-6)  
Dimensions shown in millimeters

## ORDERING GUIDE

| Model            | R <sub>AB</sub> (kΩ) | Temperature Range | Package Description | Package Option | Branding |
|------------------|----------------------|-------------------|---------------------|----------------|----------|
| AD5246BKS5-R2    | 5                    | -40°C to +125°C   | 6-lead SC70         | KS-6           | D16      |
| AD5246BKS5-RL7   | 5                    | -40°C to +125°C   | 6-lead SC70         | KS-6           | D16      |
| AD5246BKS10-R2   | 10                   | -40°C to +125°C   | 6-lead SC70         | KS-6           | D1D      |
| AD5246BKS10-RL7  | 10                   | -40°C to +125°C   | 6-lead SC70         | KS-6           | D1D      |
| AD5246BKS50-R2   | 50                   | -40°C to +125°C   | 6-lead SC70         | KS-6           | D1C      |
| AD5246BKS50-RL7  | 50                   | -40°C to +125°C   | 6-lead SC70         | KS-6           | D1C      |
| AD5246BKS100-R2  | 100                  | -40°C to +125°C   | 6-lead SC70         | KS-6           | D1A      |
| AD5246BKS100-RL7 | 100                  | -40°C to +125°C   | 6-lead SC70         | KS-6           | D1A      |
| AD5246EVAL       | See Note 1           |                   | Evaluation Board    |                |          |

<sup>1</sup> The evaluation board is shipped with the 10 kΩ R<sub>AB</sub> resistor option; however, the board is compatible with all available resistor value options.

**AD5246**

**NOTES**

**NOTES**

**AD5246**

## **NOTES**

Purchase of licensed I<sup>2</sup>C components of Analog Devices or one of its sublicensed Associated Companies conveys a license for the purchaser under the Philips I<sup>2</sup>C Patent Rights to use these components in an I<sup>2</sup>C system, provided that the system conforms to the I<sup>2</sup>C Standard Specification as defined by Philips.

© 2003 Analog Devices, Inc. All rights reserved. Trademarks and registered trademarks are the property of their respective owners.  
C03875-0-9/03(0)



[www.analog.com](http://www.analog.com)