

Series PVT412A

Microelectronic Power IC

HEXFET® Power MOSFET Photovoltaic Relay
Single Pole, Normally Open,
0-400V, 240mA AC / 360mA DC

General Description

The PVT412A Series Photovoltaic Relay is a single-pole, normally open solid-state relay that can replace electromechanical relays in many applications. It utilizes International Rectifier's proprietary HEXFET power MOSFET as the output switch, driven by an integrated circuit photovoltaic generator of novel construction. The output switch is controlled by radiation from a GaAlAs light emitting diode (LED) which is optically isolated from the photovoltaic generator.

These SSRs are specifically designed for industrial control and peripheral telecom applications.

Series PVT412A Relays are packaged in a 6-lead molded DIP package with either thru-hole or surface mount ('gull-wing') terminals. It is available in standard plastic shipping tubes or on tape-and-reel. Please refer to part identification information

Applications

- Control of AC power line (up to 240 VAC) industrial loads
- Control of DC industrial loads up to +/-300 VDC
- On/Off hook switch
- Dial-pulse generation

Part Identification

PVT412A	thru-hole
PVT412AS	surface-mount
PVT412AS-T	surface-mount, Tape and Reel

Features

- HEXFET Power MOSFET output
- Bounce-free operation
- 4,000 V_{RMS} I/O isolation
- Very low on-resistance (R_{DD-ON})
- Linear AC/DC operation
- Solid-State Reliability
- UL recognized
- ESD Tolerance:
 - 4000V Human Body Model
 - 500V Machine Model

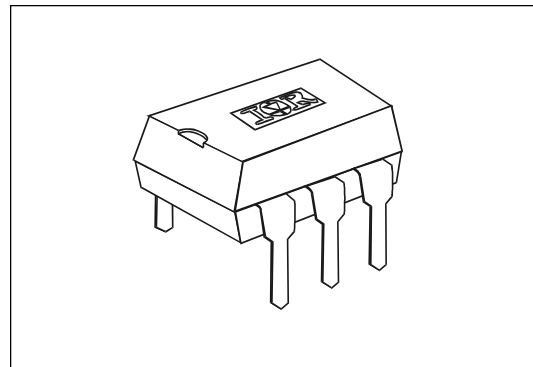

(HEXFET is the registered trademark for International Rectifier Power MOSFETs)

Series PVT412A

International
IR Rectifier

Electrical Specifications 0-400V, 240ma,AC (T_A = +25°C) unless otherwise specified)

INPUT CHARACTERISTICS	Limits	Units
Minimum Control Current (see figure 1)	3.0	mA
Maximum Control Current for Off-State Resistance	0.4	mA
Control Current Range (Caution: current limit input LED, see figure 5)	3.0 to 25	mA
Maximum Reverse Voltage	7.0	V

OUTPUT CHARACTERISTICS	Limits	Units
Operating Voltage Range	0 to ±400	V peak
Maximum Load Current @ T _A =+40°C 5mA Control (see figure 1)		
A Connection	240	mA
B Connection	260	mA
C Connection	360	mA
Maximum On-State Resistance @T _A =+25°C 100mA Pulsed Load, 5mA Control (see figures 2 & 3)		
A Connection	6	Ω
B Connection	3	Ω
C Connection	2	Ω
Max. pulsed Load Current @T _A =+25°C, ±400V, 5mA Control (10mS @ 10% duty cycle)	750	mA
Maximum Off-State Leakage @T _A =+25°C, ±400V	1.0	μA
Maximum Turn-On Time @T _A =+25°C (see figures 6 & 7) For 50mA, 100 V _{DC} load, 5mA Control (5mS pulse width @ 50% duty cycle)	3.0	ms
Maximum Turn-Off Time @T _A =+25°C (see figures 6 & 7) For 50mA, 100 V _{DC} load, 5mA Control (5mS pulse width @ 50% duty cycle)	0.5	ms
Maximum Output Capacitance @ 50V _{DC} , f=1MHz (C _{out} , see figure 8)	40.0	pF

GENERAL CHARACTERISTICS	Limits	Units
Minimum Dielectric Strength, Input-Output	4000	V _{RMS}
Minimum Insulation Resistance, Input-Output	10 ¹²	Ω
Maximum Capacitance, Input-Output V _d =0V, f=1MHz	1.0	pF
Maximum Pin Soldering Temperature (10 seconds maximum)	+260	
Ambient Temperature Range:		°C
	Operating	-40 to +85
	Storage	-40 to +100

International Rectifier does not recommend the use of this product in aerospace, avionics, military or life support applications. Users of this International Rectifier product in such applications assume all risks of such use and indemnify International Rectifier against all damages resulting from such use.

Connection Diagrams

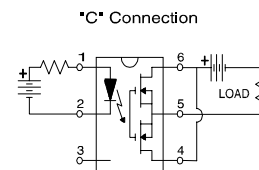
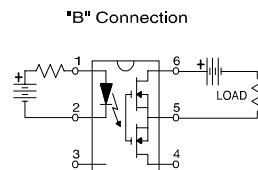
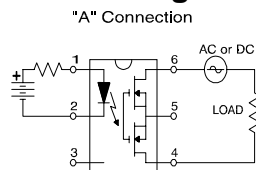

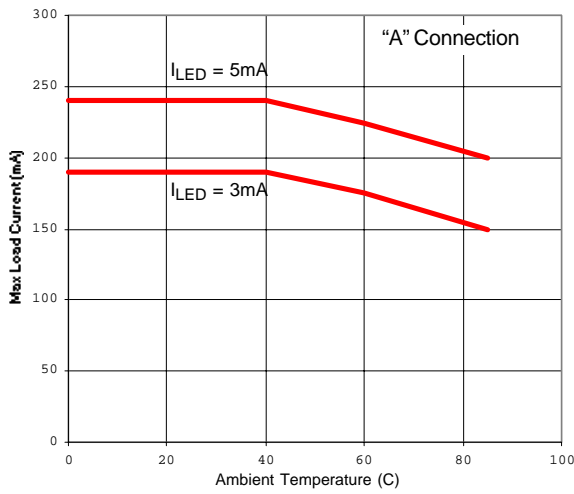

Figure 1. Current Derating Curves

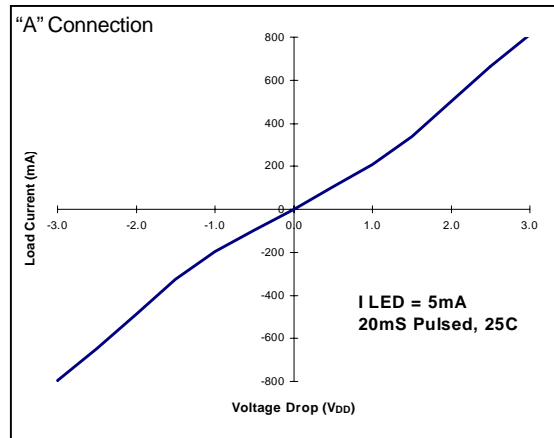

Figure 2. Typical On Characteristics

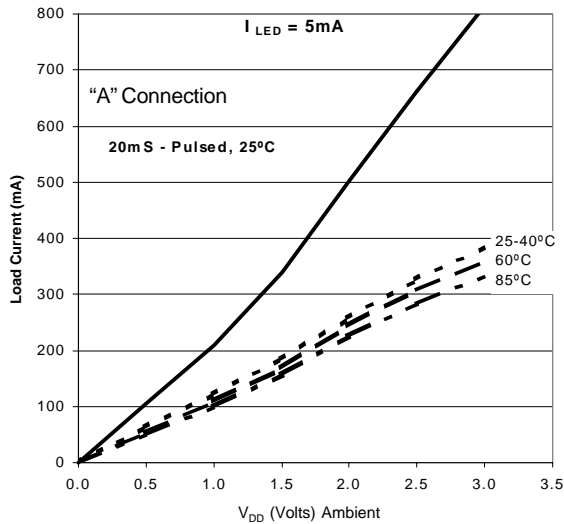

Figure 3. Typical On-Characteristics

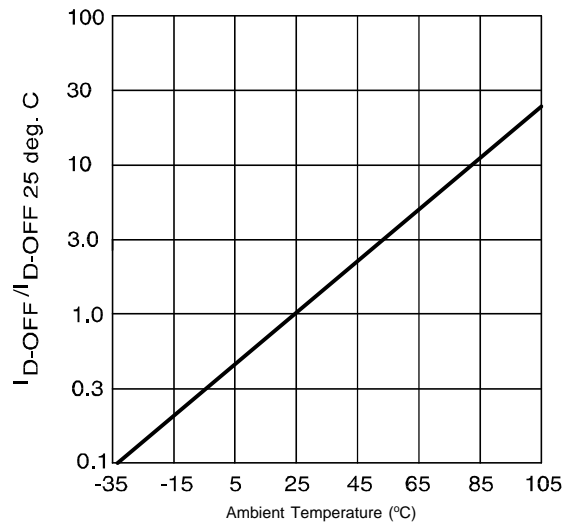

Figure 4. Typical Normalized Off-State Leakage

Series PVT412A

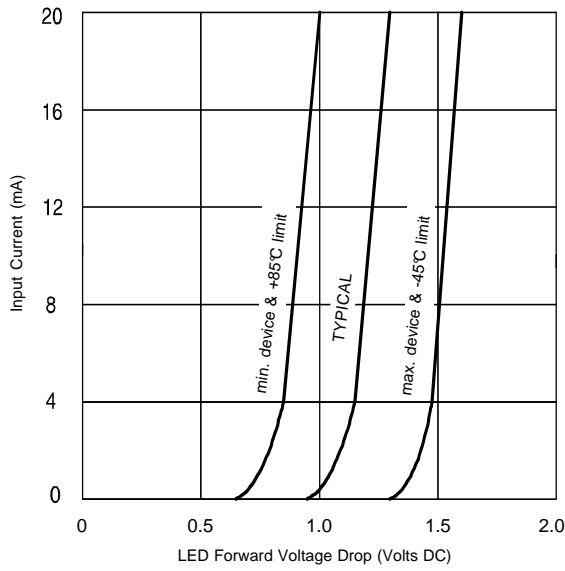

Figure 5. Input Characteristics (Current Controlled)

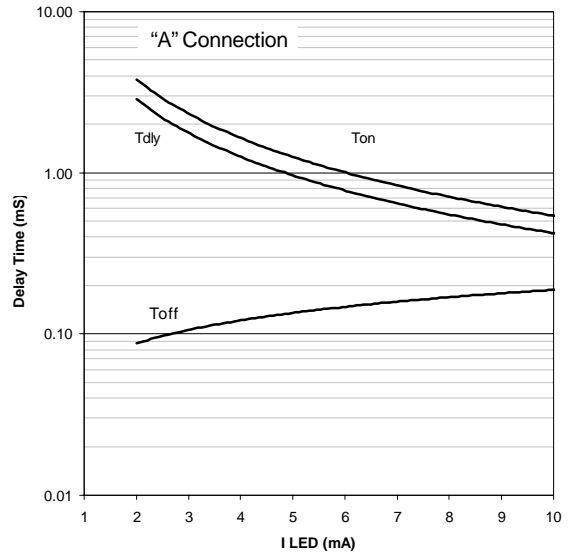

Figure 6. Typical Delay Times

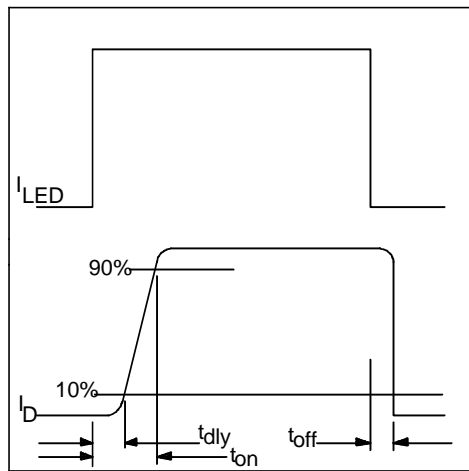

Figure 7. Delay Time Definitions

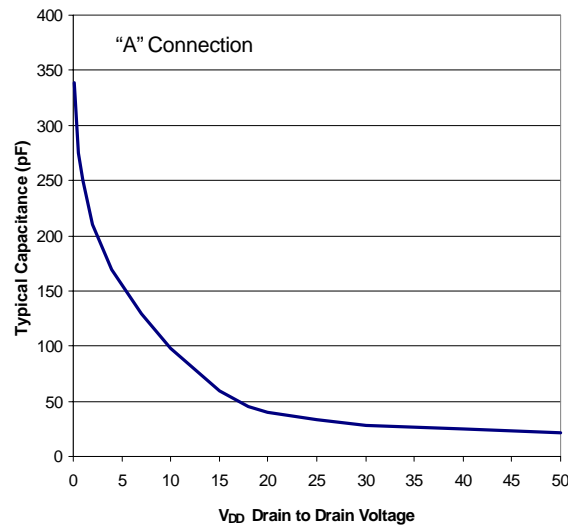

Figure 8. Typical Output Capacitance

Case Outlines

