

TOSHIBA SOLID STATE GTR DRIVER MODULE

# TF1204

GTR DRIVER

Unit in mm

TOSHIBA TF1204 is the GTR driver designed for use with TOSHIBA Giant Transistor Module and it includes the optical isolator and GTR driver circuit. Using this driver, you can design high reliability and compact system.

- 2000V<sub>RMS</sub> Optical Isolation
- Logic Compatible Input
- High Speed Switching Response  
:  $t_{pLH} = 3\mu s$ ,  $t_{pHL} = 4\mu s$  (Typ.)
- Small Size and Light Weight

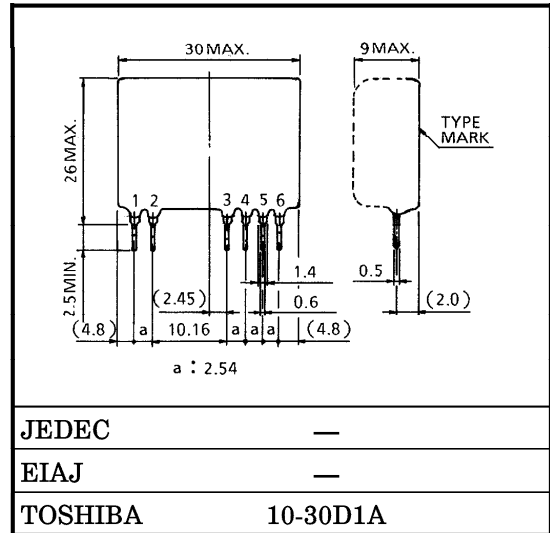

Weight : 8g

MAXIMUM RATINGS (Ta = 25°C)

CHARACTERISTIC	SYMBOL	RATING	UNIT
Supply Voltage	V <sub>CC</sub>	6	V
	V <sub>EE</sub>	-4	V
Input Voltage	V <sub>IN</sub>	5.5	V
Reverse Input Voltage	V <sub>RIN</sub>	5	V
High Level Output Current	I <sub>OH</sub>	-1	A
Low Level Peak Output Current	I <sub>OLP</sub>	3 (10μs)	A
Isolation (Input-Output)	BV <sub>S</sub> /AC	2000 (1min)	V
Operating Frequency	f	5	kHz
Operating Temperature	T <sub>opr</sub>	-20~70	°C
Storage Temperature	T <sub>stg</sub>	-20~100	°C

BLOCK DIAGRAM

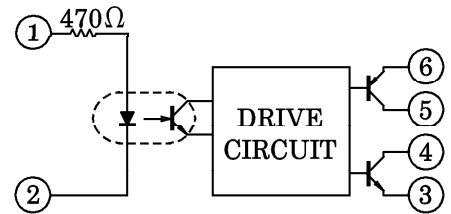

1. INPUT (+)
2. INPUT (-)
3. OUTPUT 2 (-) [V<sub>EE</sub>]
4. OUTPUT 2 (+)
5. OUTPUT 1 (-)
6. OUTPUT 1 (+) [V<sub>CC</sub>]

CIRCUIT DIAGRAM

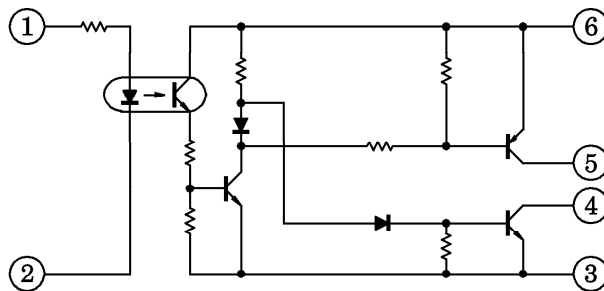

961001EBA2

● TOSHIBA is continually working to improve the quality and the reliability of its products. Nevertheless, semiconductor devices in general can malfunction or fail due to their inherent electrical sensitivity and vulnerability to physical stress. It is the responsibility of the buyer, when utilizing TOSHIBA products, to observe standards of safety, and to avoid situations in which a malfunction or failure of a TOSHIBA product could cause loss of human life, bodily injury or damage to property. In developing your designs, please ensure that TOSHIBA products are used within specified operating ranges as set forth in the most recent products specifications. Also, please keep in mind the precautions and conditions set forth in the TOSHIBA Semiconductor Reliability Handbook.

RECOMMENDED OPERATING CONDITIONS (Ta = -10~50°C)

CHARACTERISTIC	SYMBOL	TEST CONDITION	MIN.	TYP.	MAX.	UNIT
Supply Voltage	V <sub>CC</sub>	—	4.5	5.0	5.5	V
	V <sub>EE</sub>	—	-2.5	-3.0	-3.5	V
High Level Input Voltage	V <sub>IH</sub>	—	—	5	—	V
External Resistor	R <sub>ex1</sub>	—	—	3.9	—	Ω
	R <sub>ex2</sub>	—	—	0.5	—	Ω
Operating Frequency	f	—	—	2	—	kHz

ELECTRICAL CHARACTERISTICS (Ta = 25°C, V<sub>CC</sub> = 5V, V<sub>EE</sub> = -3V, R<sub>ex1</sub> = 3Ω, R<sub>ex2</sub> = 0.22Ω)

CHARACTERISTIC	SYMBOL	TEST CONDITION	MIN.	TYP.	MAX.	UNIT
Input Current	I <sub>IN</sub>	V <sub>IN</sub> = 5V	7	8	9	mA
High Level Input Voltage	V <sub>IH</sub>	I <sub>OH</sub> = -1A	—	2	4.5	V
Low Level Input Voltage	V <sub>IL</sub>	I <sub>OLP</sub> = 3A	1.0	2	—	V
High Level Output Current	I <sub>OH</sub>	V <sub>IN</sub> = 5V, V <sub>O</sub> = 1.5V	—	-1	—	A
Low Level Peak Output Current	I <sub>OLP</sub>	V <sub>IN</sub> = 0V	—	3	—	A
(Low→High) Propagation Delay Time	t <sub>pLH</sub>	V <sub>IN</sub> = 0→5V	—	3	10	μs
(High→Low) Propagation Delay Time	t <sub>pHL</sub>	V <sub>IN</sub> = 5→0V	—	4	10	μs
Power Dissipation	P <sub>D</sub>	f = 2kHz, D.f = 50%	—	440	—	mW

TEST CIRCUIT

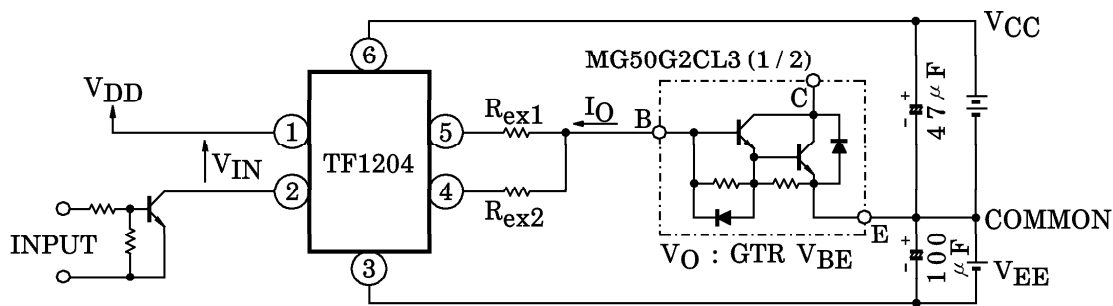

INPUT VOLTAGE  
(V<sub>IN</sub>)

GTR BASE CURRENT  
(-I<sub>O</sub>)

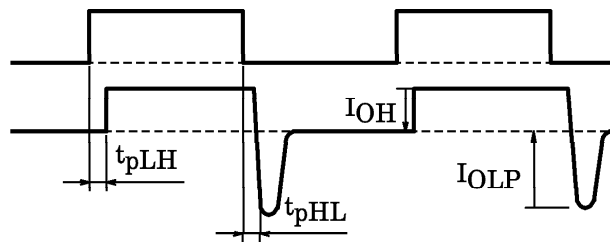

961001EBA2'

- The products described in this document are subject to foreign exchange and foreign trade control laws.
- The information contained herein is presented only as a guide for the applications of our products. No responsibility is assumed by TOSHIBA CORPORATION for any infringements of intellectual property or other rights of the third parties which may result from its use. No license is granted by implication or otherwise under any intellectual property or other rights of TOSHIBA CORPORATION or others.
- The information contained herein is subject to change without notice.

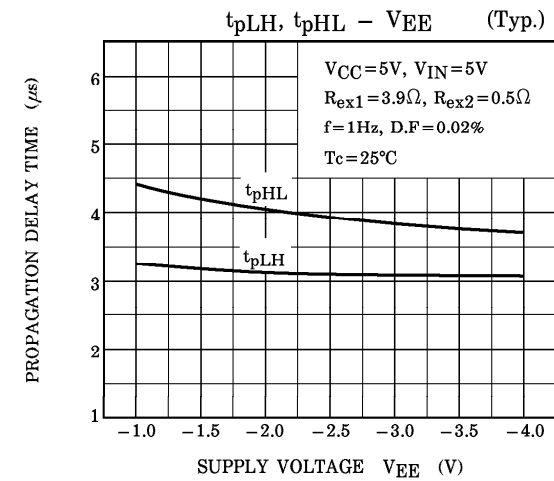
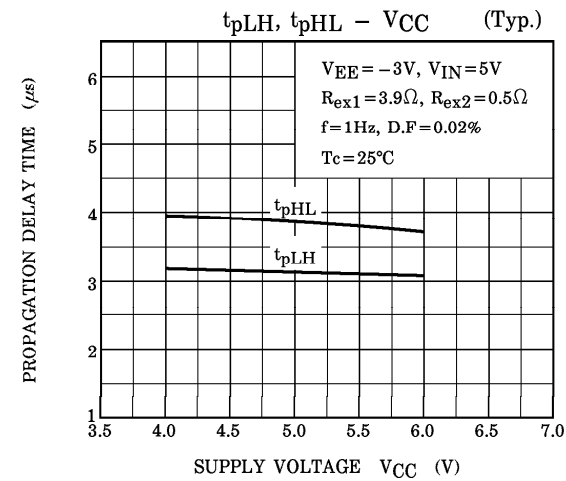
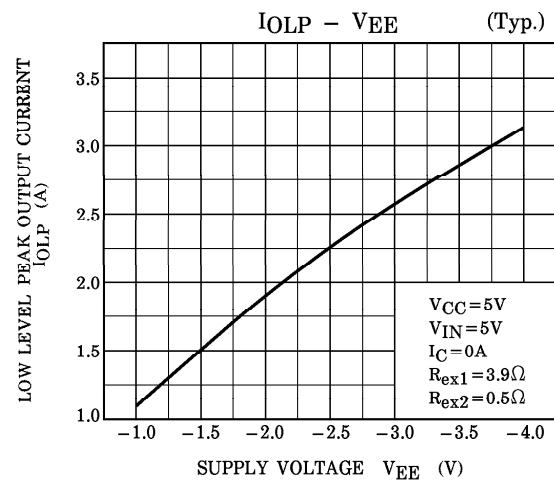
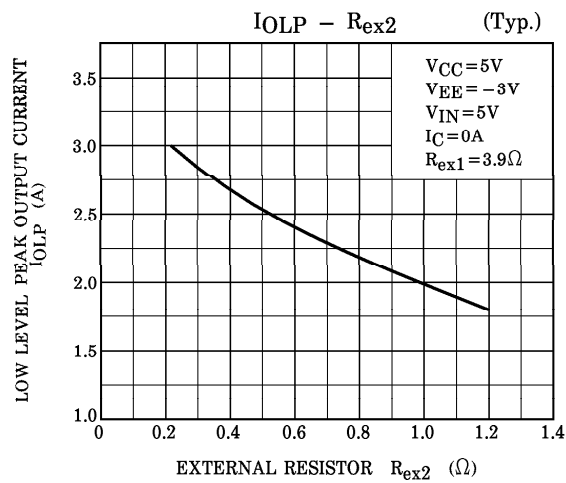
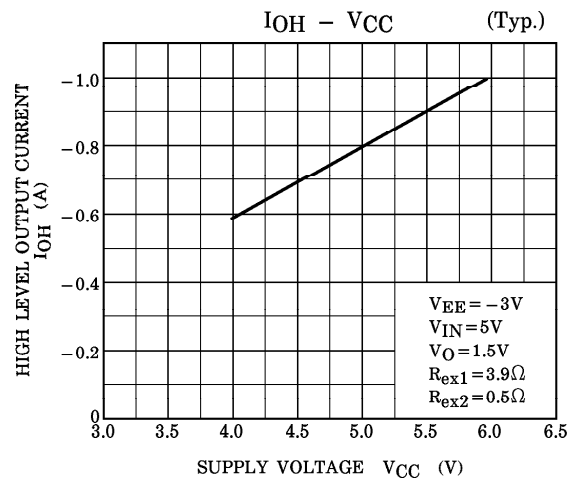
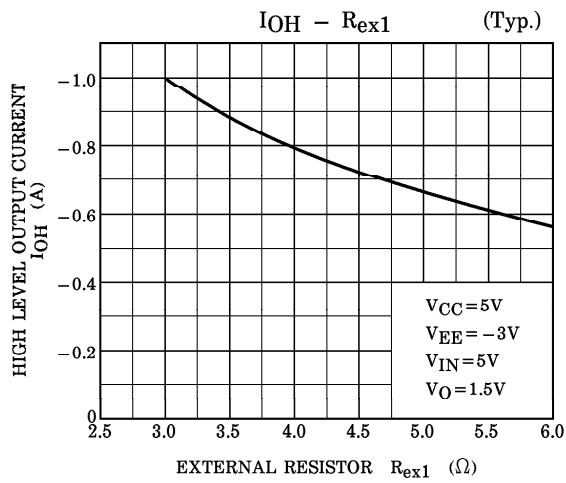

$t_{pLH}, t_{pHL} - V_{IN}$  (Typ.)

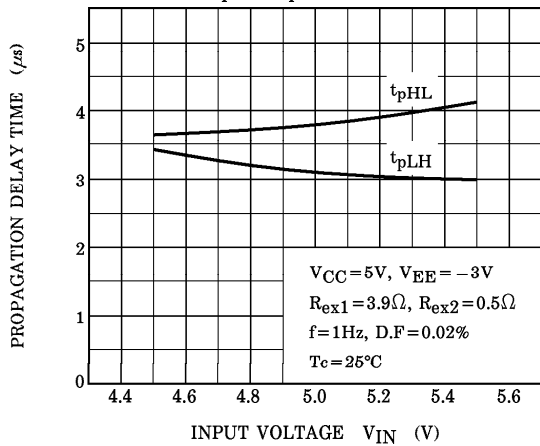

$t_{pLH}, t_{pHL} - T_a$  (Typ.)

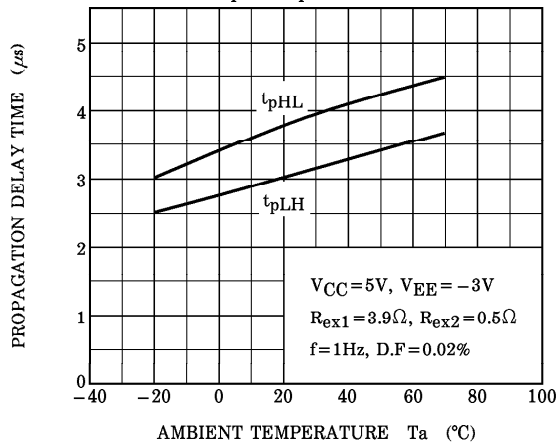

$P_D - D.F$  (Typ.)

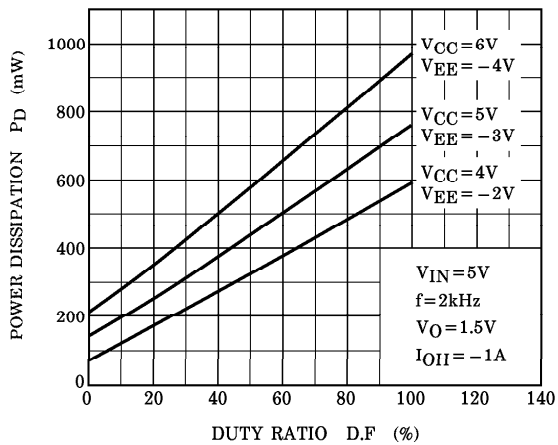

$T_a \text{ MAX.} - D.F$

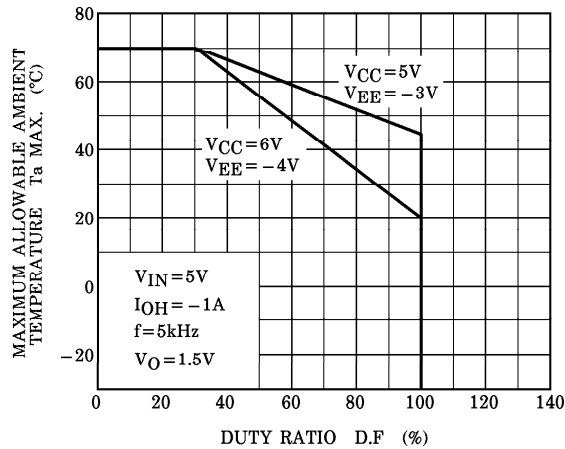

EXAMPLE OF APPLIED CIRCUIT

MG50G2CL3 BASE DRIVE CIRCUIT

(A) SINGLE SOURCE DRIVE

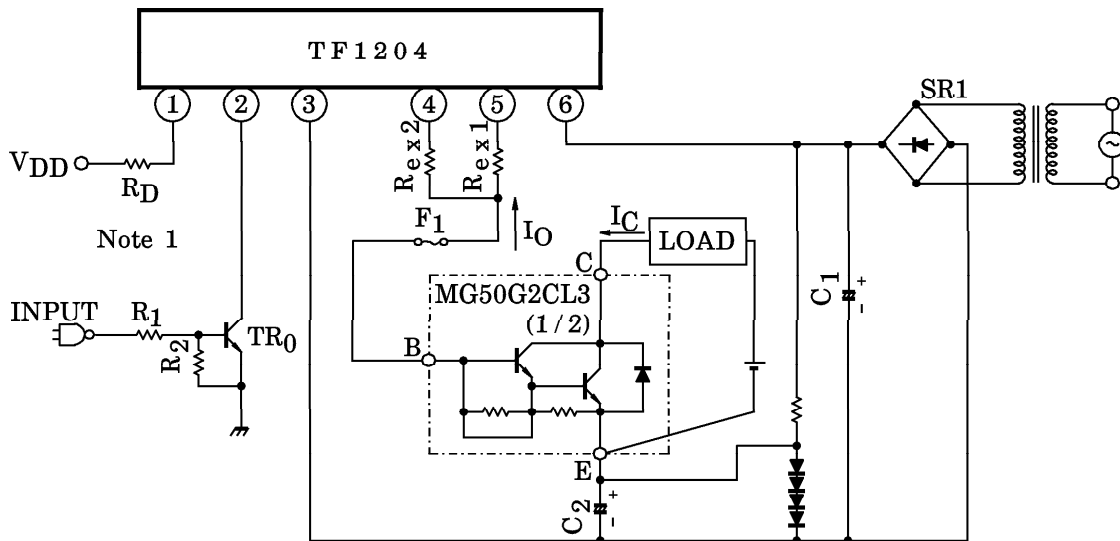

(B) DUAL SOURCE DRIVE

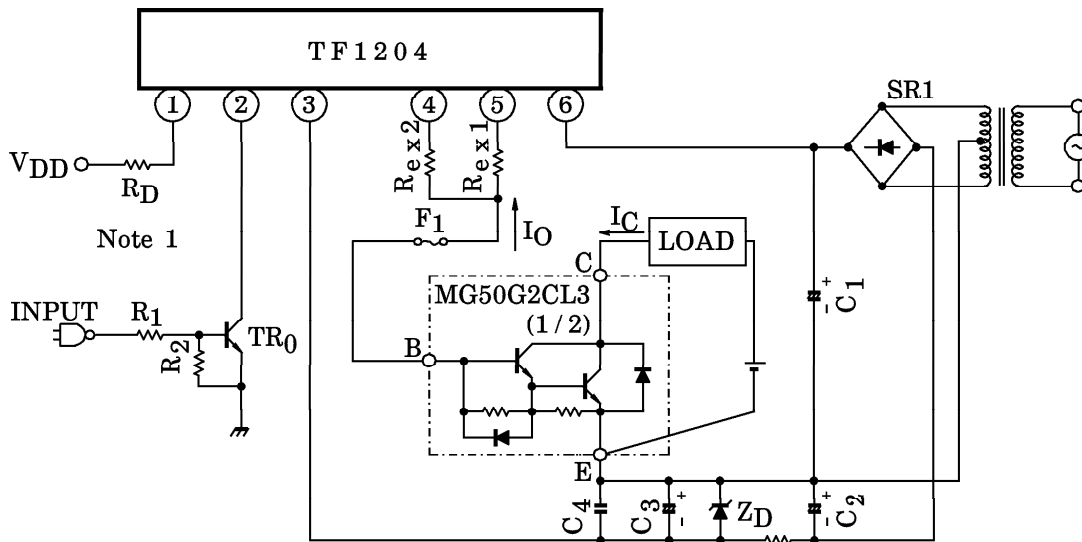

Note 1 : Insert an external resistor  $R_D$  in  $V_{DD}$  bias line when the power supply over 5.5V is used.

(Calculating Formula)

$$R_D = \frac{V_{DD} - V_F}{I_{IN}} - R_{IN}$$

$V_F$  : Forward voltage of LED ( $\approx 1$  [V])  
 $R_{IN}$  : Input resistor (470 [ $\Omega$ ])  
 $I_{IN}$  : Input current (8 [mA])