

Pin Description

No.	Symbol	I/O signal	Equivalent circuit	Description
1	SAG	Inputs VIDEO OUT through capacitor		Input pin of sag compensation signal
2	GND2	GND*		GND for driver and IRIS
3	GND1	GND*		GND for other than driver, sample hold and IRIS
4	SYNC	 High: 4.5V and above* Low: 0.5V and below T: 5μs		Sync pulse input pin (active at Low)
5	SET CONT			Set-up level adjusting pin
		GND*		Turns to preset mode 1
		2 to 3.5V*		Control mode
		Vcc*		Turns to preset mode 2
6	WC CONT			White clip level adjusting pin
		GND*		Preset mode
		2 to 3.5V*		Control mode

* External applied voltage

No.	Symbol	I/O signal	Equivalent circuit	Description
7	DRIVER IN	Input γ OUT through capacitor or LINEAR		Input pin to driver
8	γ OUT	 DC 2V		Gamma correction signal output pin. Outputs γ 1 when Pin 9 is at OPEN Outputs γ 2 when Pin 9 is turned to 5V
9	LINEAR	 DC 1.8V		Linear signal (γ -OFF signal) output pin
		V_{CC}^*		Pin 8 output signal turns to γ 2 output
10	γ CLP			Capacitor connecting pin for gamma input clamp
11	γ IN	 Input DC permissible range DC 2 to 3V*		Input pin of the gamma correction circuit

* External applied voltage

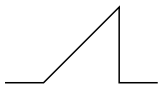
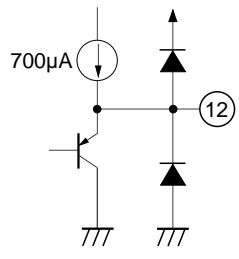
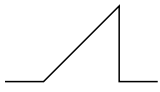
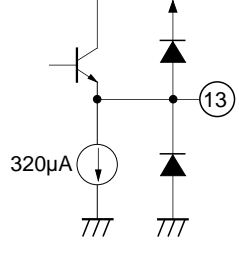
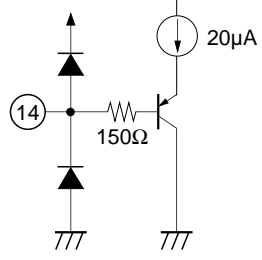
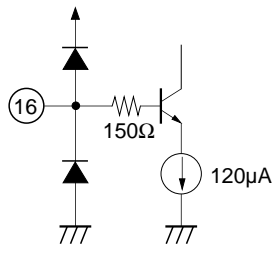
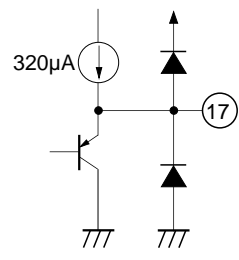
No.	Symbol	I/O signal	Equivalent circuit	Description
12	AGC OUT	 <p>Vp-p MAX 1300mV Vp-p TYP 500mV DC 2.55V</p>		Output pin of signal passed through AGC
13	DET OUT	 <p>MAX 1500mV TYP 500mV DC 2V</p>		Output pin of AGC detection signal
14	AGC MAX	DC*		Maximum gain setting pin of AGC amplifier
15	Vcc1	5V*		Power supply for other than driver and IRIS
16	AGC CONT	DC*		Gain control pin of AGC amplifier
17	OP OUT			Output pin of the operational amplifier

* External applied voltage

No.	Symbol	I/O signal	Equivalent circuit	Description
18	OP IN-			Inverted input pin of the operational amplifier
19	OP IN+			Non inverted input pin of the operational amplifier (AGC detection signal input pin)
20	SHD2	<p>High: 4.5V and above* Low: 0.5V and below T: 15ns and above</p>		Input pin of the sample / hold pulse (active at High)
21	SHD1	<p>High: 4.5V and above* Low: 0.5V and below T: 15ns and above</p>		Input pin of the sample / hold pulse (active at High)
22	DATA	<p>[*1] MAX 800mV [*2] MAX 800mV</p>		CCD signal input pin

* External applied voltage

No.	Symbol	I/O signal	Equivalent circuit	Description
23	PG	<p>[*1] MAX 800mV [*2] MAX 800mV</p>		CCD single input pin
24	SHP	<p>High: 4.5V and above* Low: 0.5V and below T: 15ns</p>		Input pin of the sample / hold pulse (active at High)
25	CLP2	<p>High: 4.5V and above* Low: 0.5V and below T: 2µs</p>		CLP2 pulse input pin (active at High)
26	GND3	GND*		Sample / hold GND
27	IRIS	<p>DC 1.3V</p>		Output pin of the IRIS control signal
28	IRIS CLP			Capacitor connecting pin for IRIS output clamp

* External applied voltage

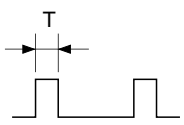
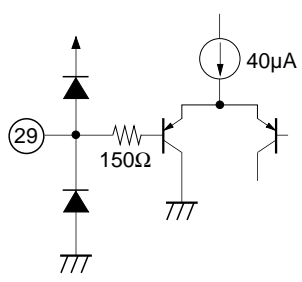
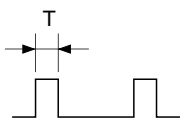
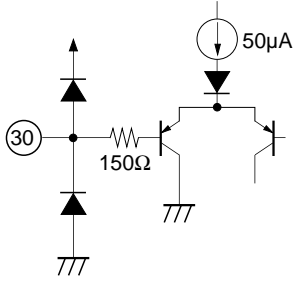
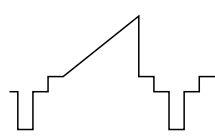
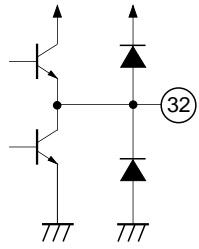
No.	Symbol	I/O signal	Equivalent circuit	Description
29	$\overline{\text{BLK}}$	 <p>High: 4.5V and above* Low: 0.5V and below T: 11μs</p>		BLK pulse input pin (active at Low)
30	CLP1	 <p>High: 4.5V and above* Low: 0.5V and below T: 2μs</p>		CLP1 pulse input pin (active at High)
31	Vcc2	5V*		Driver and IRIS power supply
32	VIDEO	 <p>BLK level 1.5V</p>		VIDEO signal output pin

* External applied voltage

Electrical Characteristics

(Ta = 25°C, Vcc = 5V, See Electrical Characteristics Test Circuit)

No.	Item	Symbol	Conditions	Min.	Typ.	Max.	Unit
1	Current consumption	Icc	Current value of Vcc1 and Vcc2 AGC CONT = 1.5V	30	45	60	mA
2	Min. value of AGC MAX	MAX	GAIN between DATA input and AGC OUT DATA input = 100mV AGC MAX = 4V, AGC CONT = 1.5V	—	18	20	dB
3	Min. value of AGC CONT	AG1	GAIN between DATA input and AGC OUT DATA input = 500mV, AGC CONT = 5V	—	4	6	dB
4	Max. value of AGC CONT	AG2	GAIN between DATA input and AGC OUT DATA input = 30mV, AGC CONT = 1.5V	30	32	—	dB
5	AGC CONT 10dB	AG3	GAIN between DATA input and AGC OUT DATA input = 320mV, AGC CONT = 3.55V	8	10	12	dB
6	AGC OUT DC	ADC	DC output level of AGC OUT	2.25	2.55	2.85	V
7	γ 1 output level	γ 1	Test value of γ 1 output level γ IN input = 500mV	530	630	730	mV
8	γ 2 output level	γ 2	Test value of γ 2 output level γ IN input = 500mV, S9 ON	580	680	780	mV
9	LINEAR AMP GAIN	LG	GAIN between γ IN input and LINEAR γ IN input = 500mV	1.6	2.6	3.6	dB
10	DET OUT DC	DDC	DC output level of DET OUT	1.8	2.0	2.2	V
11	IRIS AMP GAIN	IG	GAIN between DATA input and IRIS DATA input = 300mV	8	10	12	dB
12	IRIS OUT DC	IDC	DC output level of IRIS	1.1	1.3	1.5	V
13	DRIVER GAIN	DG	GAIN between DRIVER IN and VIDEO DRIVER IN = 700mV	5.7	6.0	6.3	dB
14	SYNC level	SY	SYNC level/DG* of VIDEO output	270	293	316	mV
15	SETUP 1	SE1	SETUP level of preset mode 1 SETUP level/DG* of VIDEO output	-15	0	15	mV
16	SETUP 2	SE2	SETUP level of preset mode 2 SETUP level/DG* of VIDEO output	0	20	40	mV
17	Min. value of SET CONT	SE3	SETUP level/DG* of VIDEO output SET CONT = 2V	—	-3	15	mV
18	Max. value of SET CONT	SE4	SETUP level/DG* of VIDEO output SET CONT = 3.3V	80	130	—	mV
19	W-CLIP level	WC1	W-CLIP level /DG* of VIDEO output DRIVER IN = 1500mV, WC CONT = GND	780	820	860	mV
20	Min. value of WC CONT	WC2	W-CLIP level /DG* of VIDEO output DRIVER IN = 1500mV, WC CONT = 2.2V	—	300	600	mV
21	Max. value of WC CONT	WC3	W-CLIP level /DG* of VIDEO output DRIVER IN = 1500mV, WC CONT = 3.3V	1000	1300	—	mV
22	OP AMP output D range Low level	OPL	DC output level of OP OUT OP IN+ = 2.5V, OP IN- = 4V	—	0.8	1.2	V
23	OP AMP output D range High level	OPH	DC output level of OP OUT OP IN+ = 4V, OP IN- = 2.5V	4.5	4.8	—	V

Electrical Characteristics Test Circuit

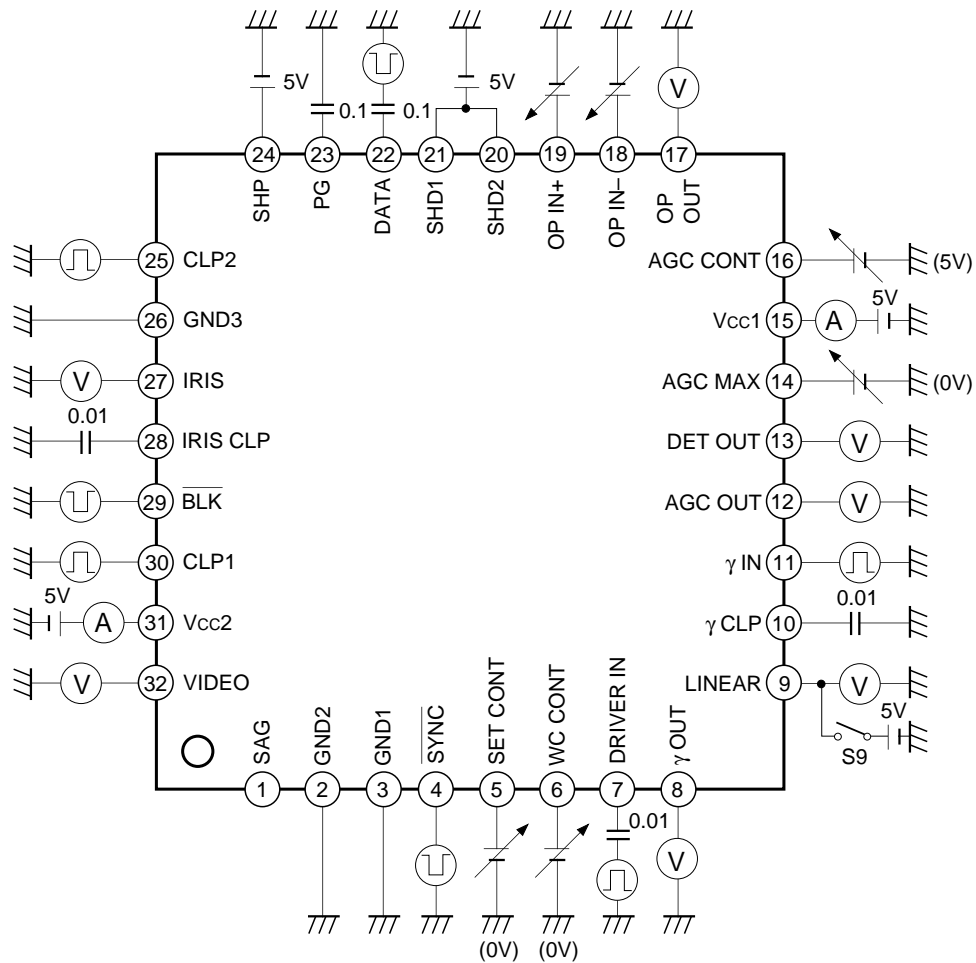

Notes)

1. μF is the capacitance unit of the capacitor.
2. For Pins 5, 6, 14 and 16, apply voltage in brackets unless otherwise specified in the conditions column of the Electrical Characteristics.
3. $\text{\textcircled{V}}$ indicates a test pin. (Test AC, DC voltage)
4. For Pins 7, 11 and 22, the input signal level is at 0mV, unless otherwise specified in the conditions column of the Electrical Characteristics.

Test Circuit I/O Waveform Diagram

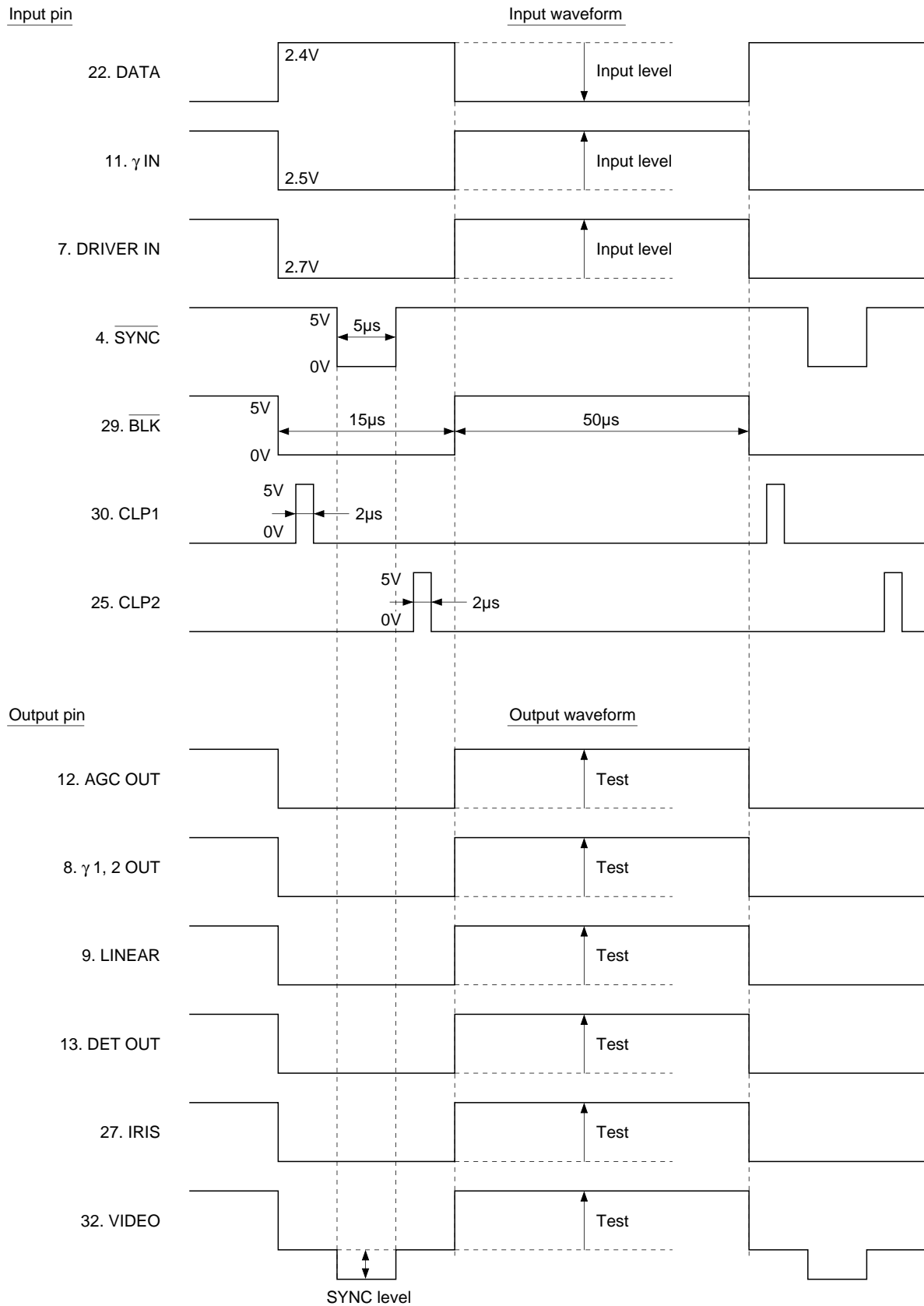

Application Circuit

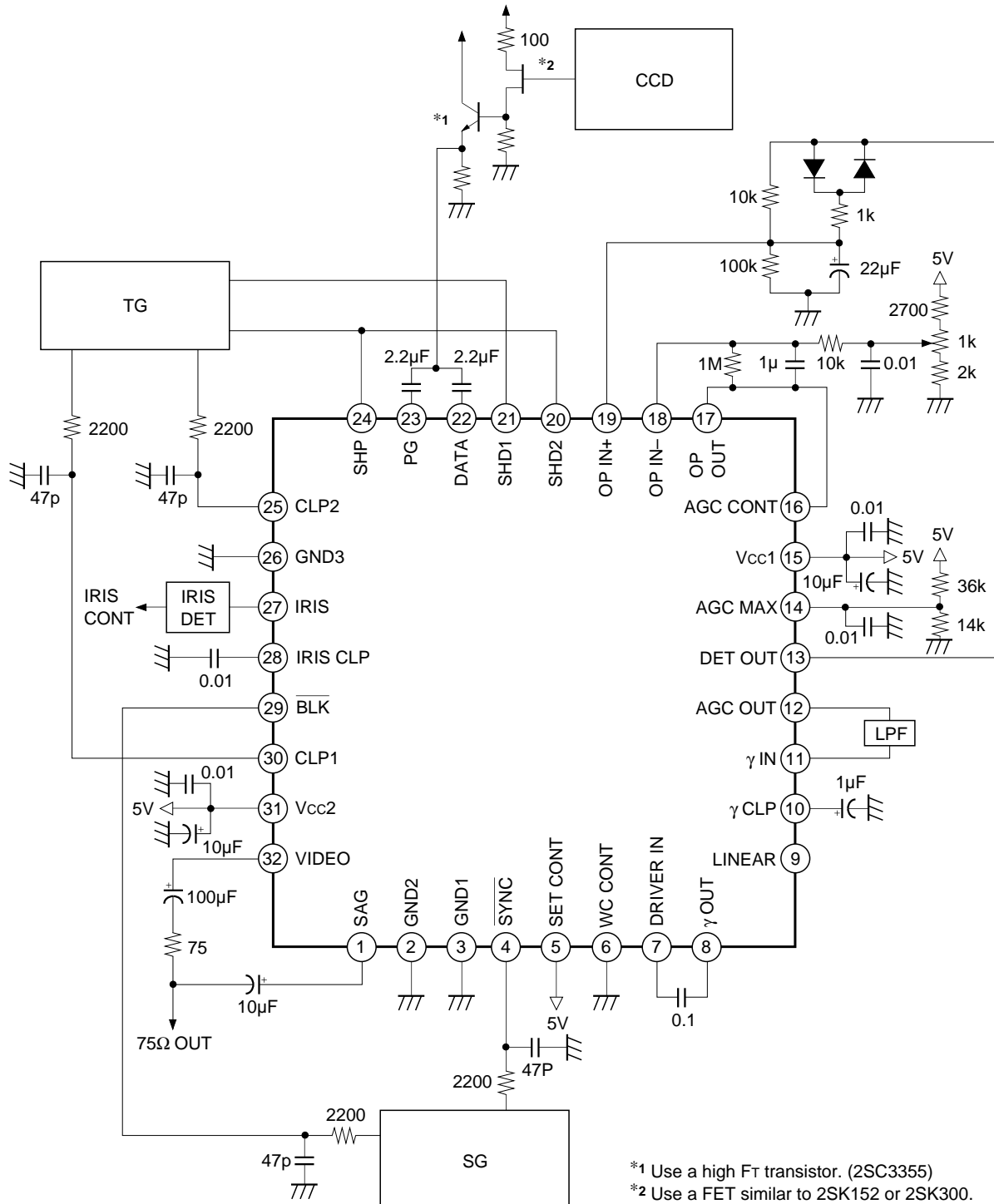

Application circuits shown are typical examples illustrating the operation of the devices. Sony cannot assume responsibility for any problems arising out of the use of these circuits or for any infringement of third party patent and other right due to same.

Example of Representative Characteristics ($V_{CC} = 5V$, $T_a = 25^\circ C$)

AGC control characteristics

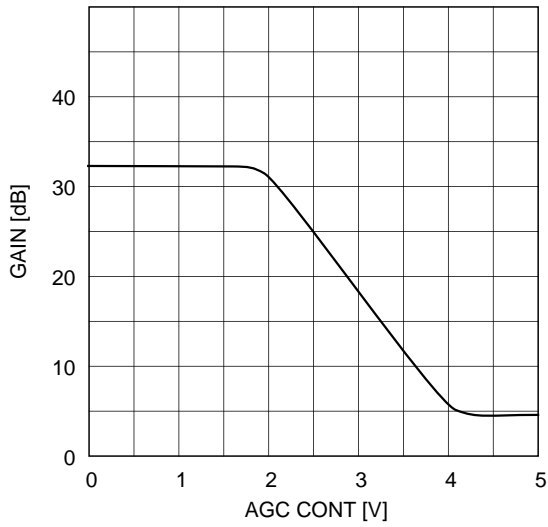

AGC MAX control characteristics

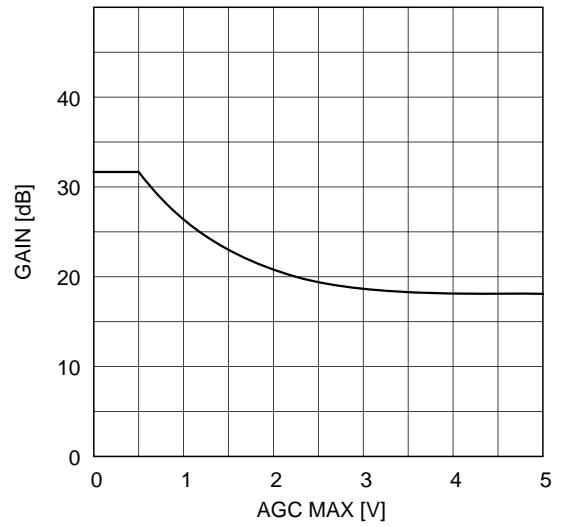

White clip control characteristics

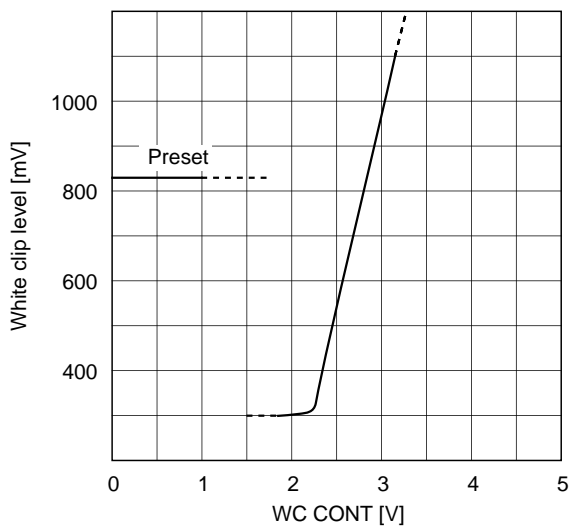

Setup control characteristics

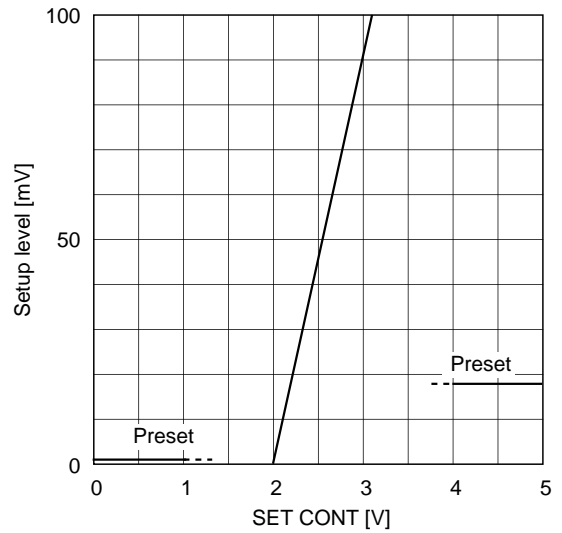

$\gamma 1$ I/O characteristics

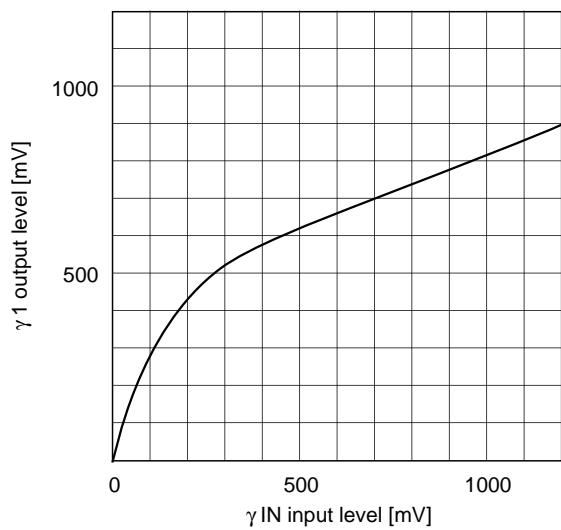

$\gamma 2$ I/O characteristics

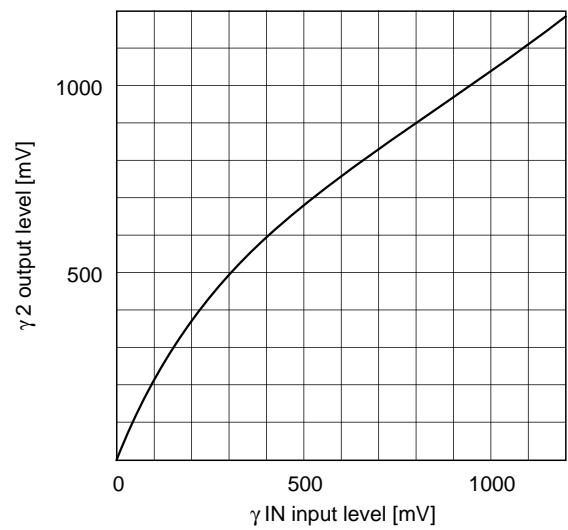

Package Outline Unit: mm

32PIN QFP (PLASTIC)

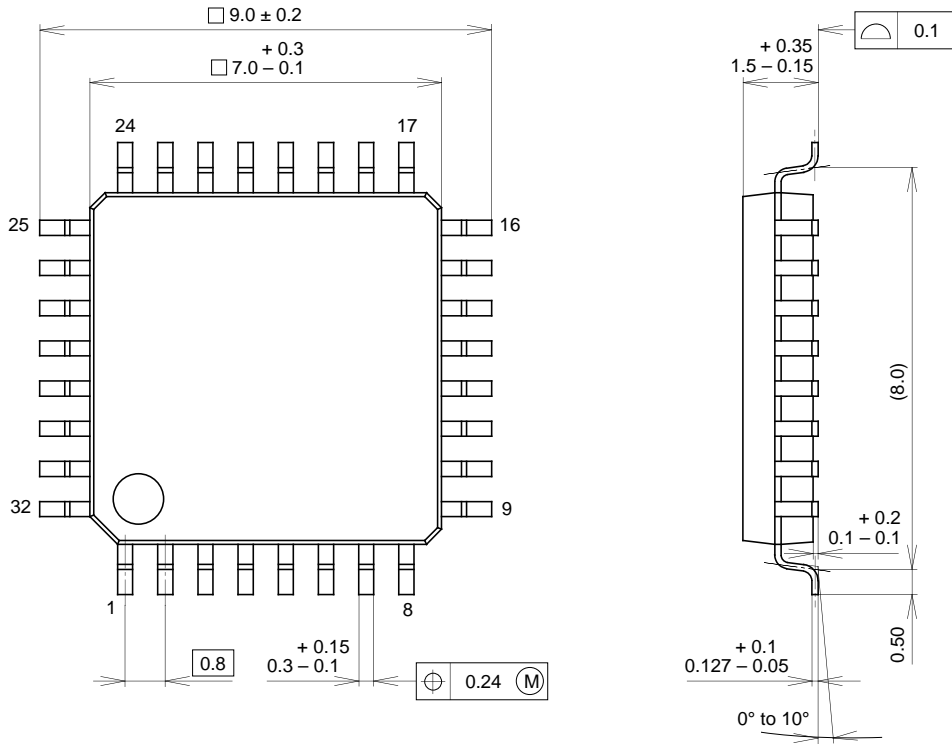

SONY CODE	QFP-32P-L01
EIAJ CODE	QFP032-P-0707
JEDEC CODE	_____

PACKAGE MATERIAL	EPOXY RESIN
LEAD TREATMENT	SOLDER PLATING
LEAD MATERIAL	42 ALLOY
PACKAGE MASS	0.2g