

750MHz, Low Distortion Unity Gain, Closed Loop Buffer

November 1998

Features

- This Circuit is Processed in Accordance to MIL-STD-883 and is Fully Conformant Under the Provisions of Paragraph 1.2.1.
- Fixed Gain of +1
- Wide -3dB Bandwidth 750MHz (Typ)
- Very Fast Slew Rate 1250V/ μ s (Typ)
- Low Differential Gain and Phase ... 0.04%/0.025 Deg.
- Low Distortion (HD3, 30MHz) -80dBc (Typ)
- Excellent Gain Flatness (to 100MHz) ... ± 0.03 dB (Typ)
- Excellent Gain Accuracy 0.99V/V (Typ)
- High Output Current 60mA (Typ)

Applications

- Video Switching and Routing
- Pulse and Video Amplifiers
- Wideband Amplifiers
- RF/IF Signal Processing
- Flash A/D Driver
- Medical Imaging Systems

Description

The HFA1110/883 is a unity gain, closed loop buffer which achieves a high degree of gain accuracy, wide bandwidth, and low distortion. Manufactured on Intersil's proprietary complementary bipolar UHF-1 process, the HFA1110/883 also offers very fast slew rates, and high output current.

Component and composite video systems will also benefit from this buffer's performance, as indicated by the excellent gain flatness, and 0.04%/0.025 Degree Differential Gain/Phase specifications ($R_L = 75\Omega$).

For buffer applications desiring a standard op amp pinout, or selectable gain (-1, +1, +2), please refer to the HFA1112/883 and HFA1113/883 (featuring programmable output clamps) datasheets.

Ordering Information

PART NUMBER	TEMP. RANGE (°C)	PACKAGE	PKG. NO.
HFA1110MJ/883	-55 to 125	8 Ld CERDIP	F8.3A

Pinout

HFA1110/883
(CERDIP)
TOP VIEW

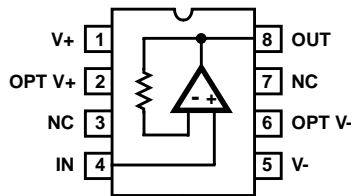

HFA1110/883

Absolute Maximum Ratings

Voltage Between V+ and V- 12V
 Voltage at Input Terminal V+ to V-
 Output Current (50% Duty Cycle) ±55mA
 ESD Rating <2000V

Operating Conditions

Supply Voltage ($\pm V_S$) ±5V
 $R_L \geq 50\Omega$
 Temperature Range $-55^\circ\text{C} \leq T_A \leq 125^\circ\text{C}$

Thermal Information

Thermal Resistance (Typical, Note 1) $\theta_{JA} (^{\circ}\text{C}/\text{W})$ $\theta_{JC} (^{\circ}\text{C}/\text{W})$
 CERDIP Package 120 35
 Maximum Package Power Dissipation at 75°C
 CERDIP Package 0.83W
 Package Power Dissipation Derating Factor above 75°C
 CERDIP Package 8.3mW/ $^{\circ}\text{C}$
 Junction Temperature 175°C
 Storage Temperature Range $-65^\circ\text{C} \leq T_A \leq 150^\circ\text{C}$
 Lead Temperature (Soldering 10s) 300°C

CAUTION: Stresses above those listed in "Absolute Maximum Ratings" may cause permanent damage to the device. This is a stress only rating and operation of the device at these or any other conditions above those indicated in the operational sections of this specification is not implied.

NOTE:

- θ_{JA} is measured with the component mounted on an evaluation PC board in free air.

TABLE 1. DC ELECTRICAL PERFORMANCE SPECIFICATIONS

Device Tested at: $V_{\text{SUPPLY}} = \pm 5\text{V}$, $R_{\text{SOURCE}} = 0\Omega$, $R_L = 100\Omega$, $V_{\text{OUT}} = 0\text{V}$, Unless Otherwise Specified.

PARAMETER	SYMBOL	CONDITIONS	GROUP A SUBGROUPS	TEMPERATURE ($^{\circ}\text{C}$)	MIN	MAX	UNITS
Output Offset Voltage	V_{OS}	$V_{\text{CM}} = 0\text{V}$	1	25	-25	25	mV
			2, 3	125, -55	-40	40	mV
Power Supply Rejection Ratio	PSRRP	$\Delta V_{\text{SUP}} = \pm 1.25\text{V}$ $V_+ = 6.25\text{V}$, $V_- = -5\text{V}$ $V_+ = 3.75\text{V}$, $V_- = -5\text{V}$	1	25	39	-	dB
			2, 3	125, -55	35	-	dB
	PSRRN	$\Delta V_{\text{SUP}} = \pm 1.25\text{V}$ $V_+ = 5\text{V}$, $V_- = -6.25\text{V}$ $V_+ = 5\text{V}$, $V_- = -3.75\text{V}$	1	25	39	-	dB
			2, 3	125, -55	35	-	dB
Input Current	I_{BSP}	$V_{\text{CM}} = 0\text{V}$	1	25	-40	40	μA
			2, 3	125, -55	-65	65	μA
Input Current Common Mode Rejection	CMS_{IBP}	$\Delta V_{\text{CM}} = \pm 2\text{V}$ $V_+ = 3\text{V}$, $V_- = -7\text{V}$ $V_+ = 7\text{V}$, $V_- = -3\text{V}$	1	25	-	40	$\mu\text{A}/\text{V}$
			2, 3	125, -55	-	50	$\mu\text{A}/\text{V}$
Input Resistance	R_{IN}	Note 2	1	25	25	-	k Ω
			2, 3	125, -55	20	-	k Ω
Gain ($V_{\text{OUT}} = 2\text{V}_{\text{p-p}}$)	A_{VP1}	$V_{\text{IN}} = -1\text{V}$ to $+1\text{V}$	1	25	0.980	1.020	V/V
			2, 3	125, -55	0.975	1.025	V/V
Output Voltage Swing	V_{OP100}	$R_L = 100\Omega$, $V_{\text{IN}} = +3.3\text{V}$	1	25	3	-	V
			2, 3	125, -55	2.5	-	V
	V_{ON100}	$R_L = 100\Omega$, $V_{\text{IN}} = -3.3\text{V}$	1	25	-	-3	V
			2, 3	125, -55	-	-2.5	V
Output Voltage Swing	V_{OP50}	$R_L = 50\Omega$, $V_{\text{IN}} = +2.7\text{V}$	1	25	2.5	-	V
		$R_L = 50\Omega$, $V_{\text{IN}} = +3.3\text{V}$	2	125	2.5	-	V
			3	-55	1.5	-	V
	V_{ON50}	$R_L = 50\Omega$, $V_{\text{IN}} = -2.7\text{V}$	1	25	-	-2.5	V
		$R_L = 50\Omega$, $V_{\text{IN}} = -3.3\text{V}$	2	125	-	-2.5	V
			3	-55	-	-1.5	V

HFA1110/883

TABLE 1. DC ELECTRICAL PERFORMANCE SPECIFICATIONS (Continued)

Device Tested at: $V_{SUPPLY} = \pm 5V$, $R_{SOURCE} = 0\Omega$, $R_L = 100\Omega$, $V_{OUT} = 0V$, Unless Otherwise Specified.

PARAMETER	SYMBOL	CONDITIONS	GROUP A SUBGROUPS	TEMPERATURE (°C)	MIN	MAX	UNITS
Output Current	+I _{OUT}	Note 3	1, 2	25, 125	50	-	mA
			3	-55	30	-	mA
	-I _{OUT}	Note 3	1, 2	25, 125	-	-50	mA
			3	-55	-	-30	mA
Quiescent Power Supply Current	I _{CC}	R _L = 100Ω	1	25	14	26	mA
			2, 3	125, -55	-	33	mA
	I _{EE}	R _L = 100Ω	1	25	-26	-14	mA
			2, 3	125, -55	-33	-	mA

NOTES:

2. Guaranteed from Input Common Mode Rejection Test, by: $R_{IN} = 1/CMS_{IBP}$.
3. Guaranteed from V_{OUT} Test with $R_L = 50\Omega$, by: $I_{OUT} = V_{OUT}/50\Omega$.

TABLE 2. ELECTRICAL TEST REQUIREMENTS

MIL-STD-883 TEST REQUIREMENTS	SUBGROUPS (SEE TABLE 1)
Interim Electrical Parameters (Pre Burn-In)	1
Final Electrical Test Parameters	1 (Note 7), 2, 3
Group A Test Requirements	1, 2, 3
Groups C and D Endpoints	1

NOTE:

4. PDA applies to Subgroup 1 only.

Test Circuit (Applies to Table 1)

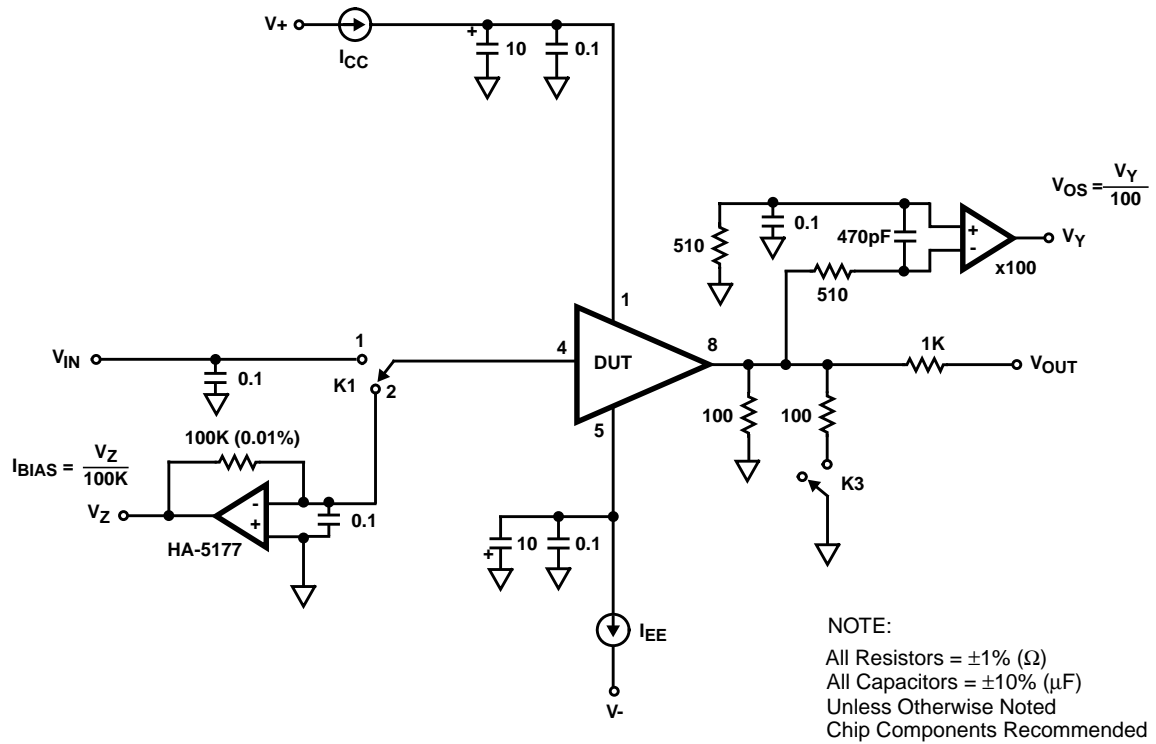

Test Waveforms

SIMPLIFIED TEST CIRCUIT FOR LARGE AND SMALL SIGNAL PULSE RESPONSE (Applies to Table 3)

$A_V = +1$ TEST CIRCUIT

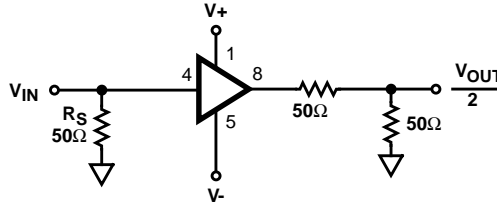

NOTE: $V_S = \pm 5V$
 $R_S = 50\Omega$
 $R_L = 100\Omega$ For Small and Large Signals

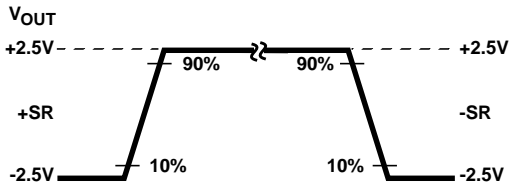

FIGURE 1. LARGE SIGNAL WAVEFORM

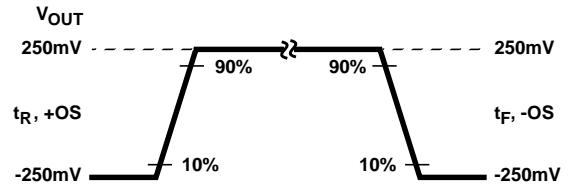
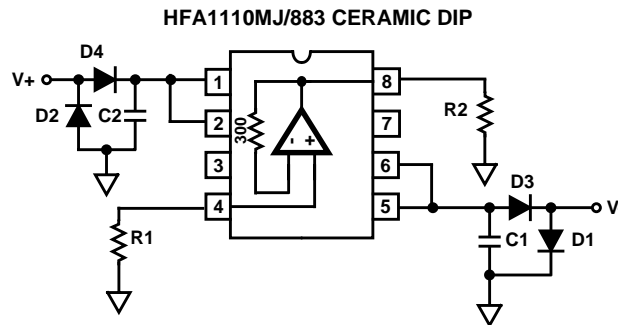

FIGURE 2. SMALL SIGNAL WAVEFORM

Burn-In Circuit



NOTES:

R1 = $1k\Omega, \pm 5\%$ (Per Socket)
 R2 = $100\Omega, \pm 5\%$ (Per Socket)
 C1 = C2 = $0.01\mu F$ (Per Socket) or $0.1\mu F$ (Per Row) Minimum

D1 = D2 = 1N4002 or Equivalent (Per Board)
 D3 = D4 = 1N4002 or Equivalent (Per Socket)
 $V+ = +5.5V \pm 0.5V$
 $V- = -5.5V \pm 0.5V$

Typical Design Information

The information contained in this section has been developed through characterization by Intersil and is for use as application and design information only. No guarantee is implied.

Typical Performance Curves $V_{SUPPLY} = \pm 5V$, $T_A = 25^\circ C$, $R_L = 100\Omega$. Unless Otherwise Specified.

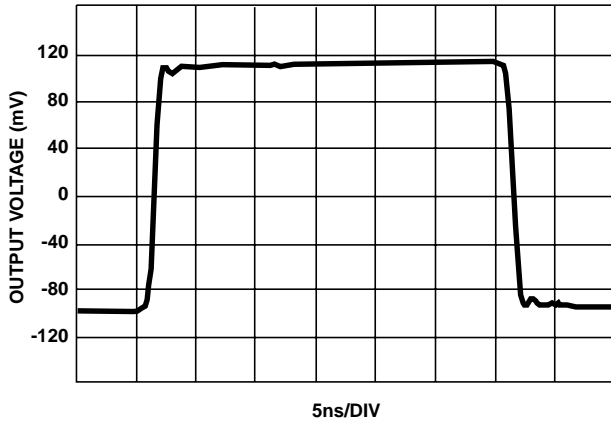

FIGURE 3. SMALL SIGNAL PULSE RESPONSE

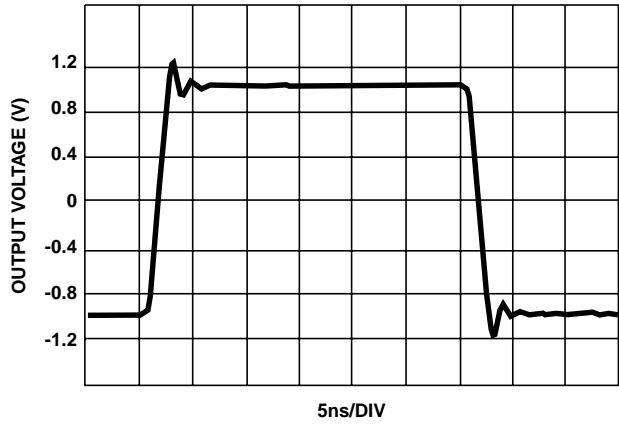

FIGURE 4. LARGE SIGNAL PULSE RESPONSE

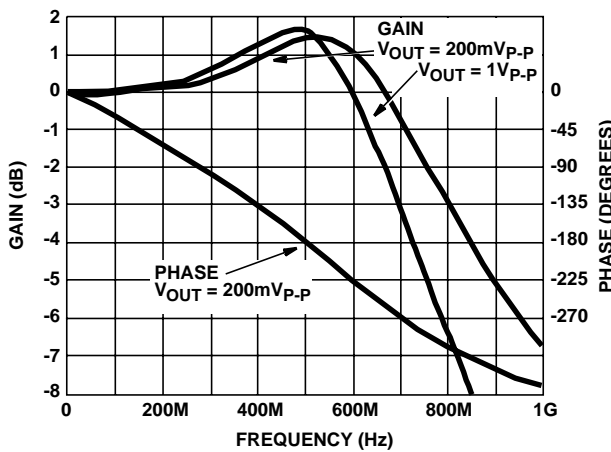

FIGURE 5. FORWARD GAIN AND PHASE

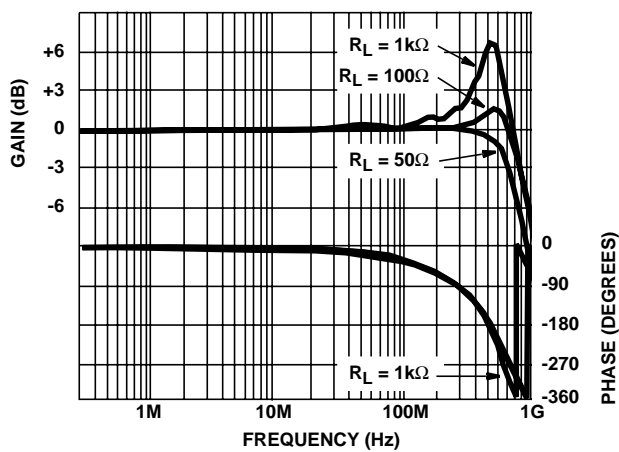

FIGURE 6. FREQUENCY RESPONSE FOR VARIOUS LOAD RESISTORS

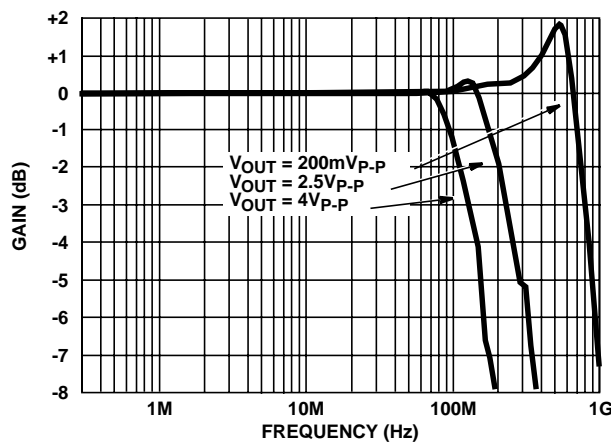

FIGURE 7. FREQUENCY RESPONSE FOR VARIOUS OUTPUT VOLTAGES

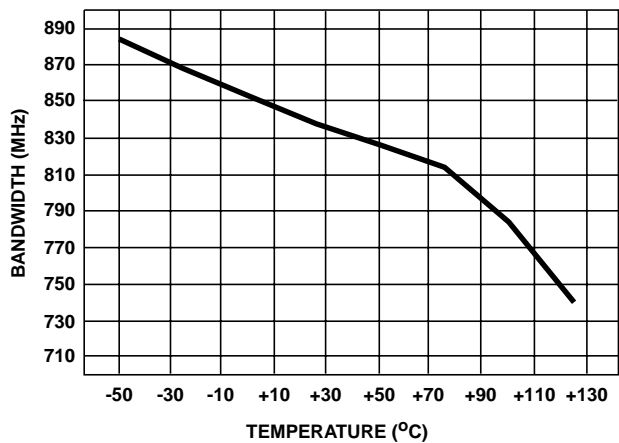

FIGURE 8. -3dB BANDWIDTH vs TEMPERATURE

Typical Performance Curves $V_{SUPPLY} = \pm 5V$, $T_A = 25^\circ C$, $R_L = 100\Omega$. Unless Otherwise Specified. (Continued)

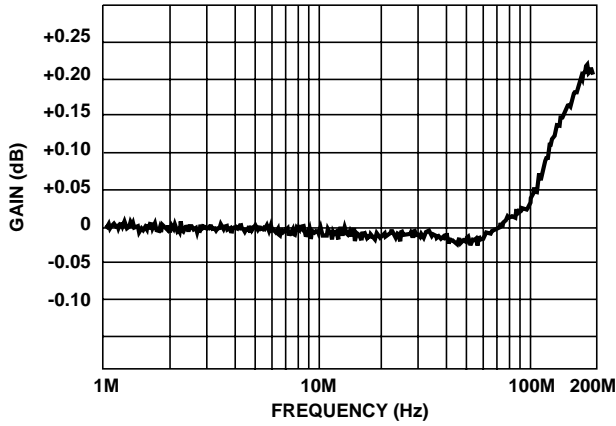

FIGURE 9. GAIN FLATNESS

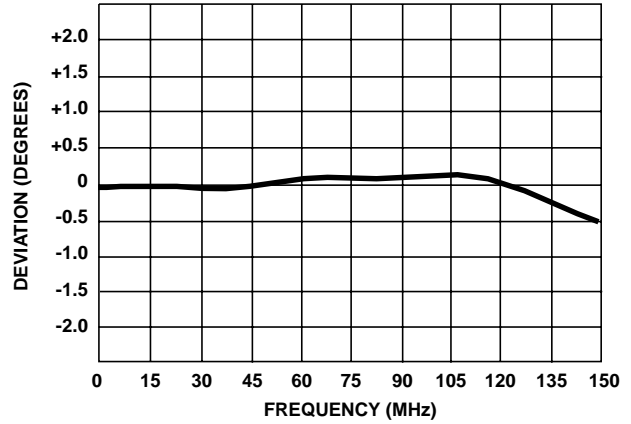

FIGURE 10. DEVIATION FROM LINEAR PHASE

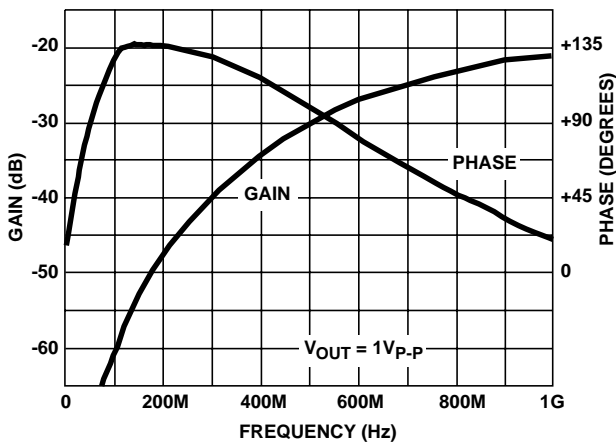

FIGURE 11. REVERSE GAIN AND PHASE

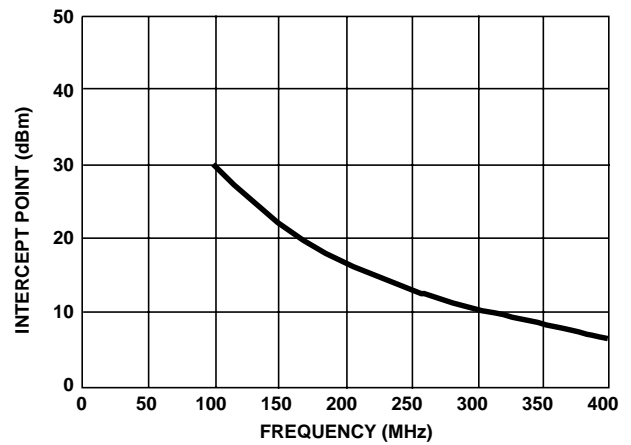

FIGURE 12. 2 TONE, 3RD ORDER INTERMODULATION INTERCEPT

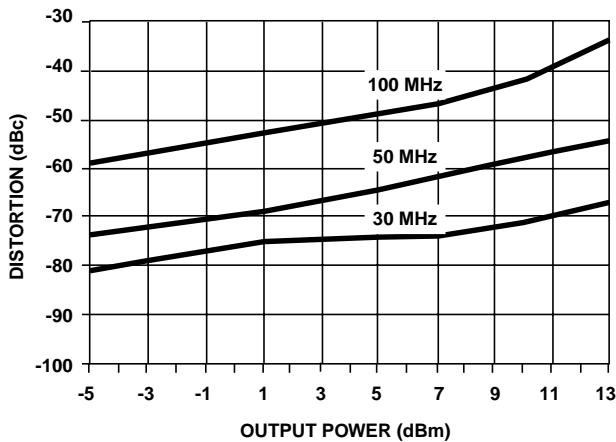

FIGURE 13. 2ND HARMONIC DISTORTION vs P_{OUT}

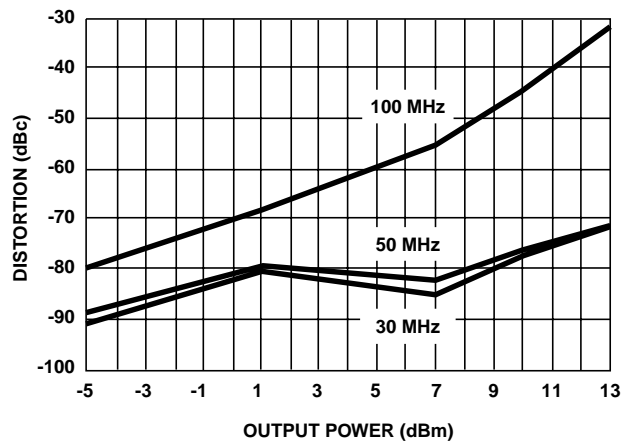

FIGURE 14. 3RD HARMONIC DISTORTION vs P_{OUT}

Typical Performance Curves $V_{SUPPLY} = \pm 5V$, $T_A = 25^\circ C$, $R_L = 100\Omega$. Unless Otherwise Specified. (Continued)

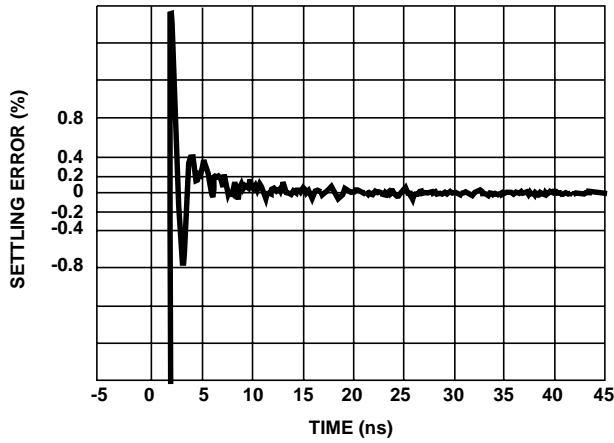

FIGURE 15. SETTLING RESPONSE ($V_{OUT} = 1V$)

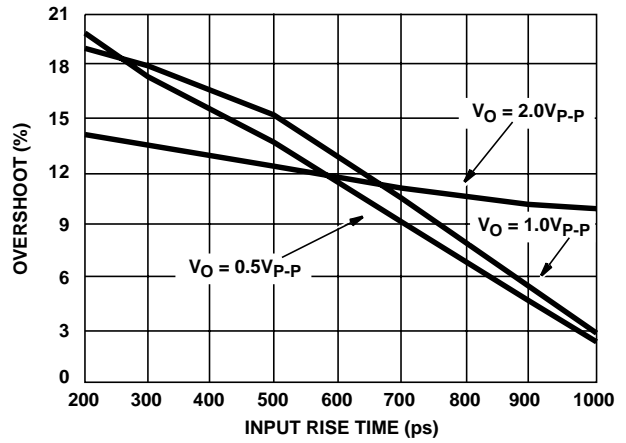

FIGURE 16. OVERSHOOT vs INPUT RISE TIME

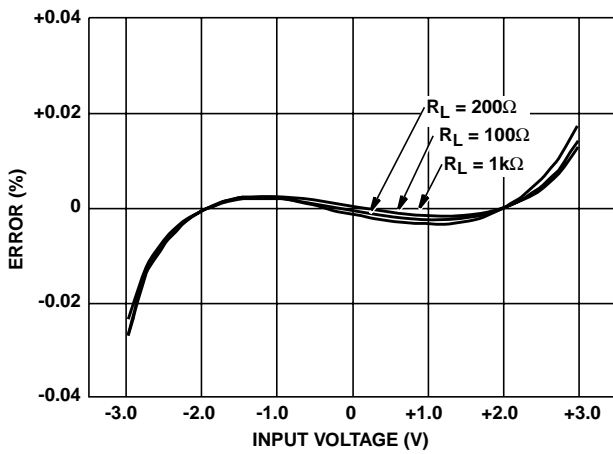

FIGURE 17. INTEGRAL LINEARITY ERROR

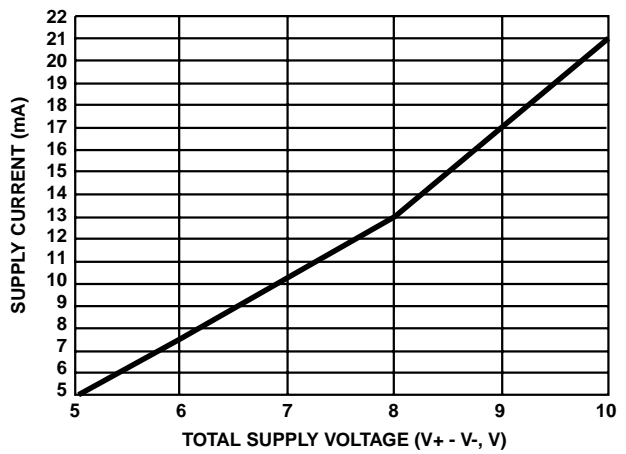

FIGURE 18. SUPPLY CURRENT vs SUPPLY VOLTAGE

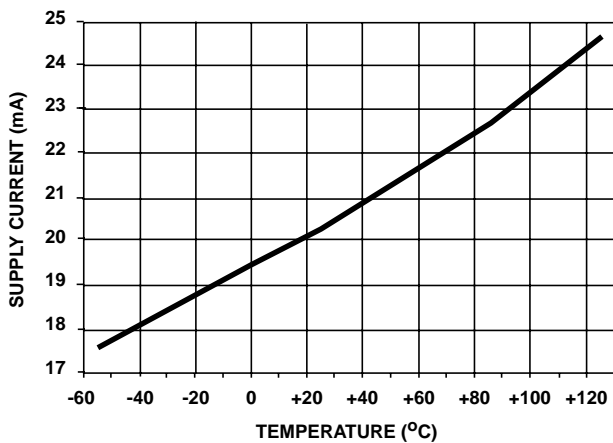

FIGURE 19. SUPPLY CURRENT vs TEMPERATURE

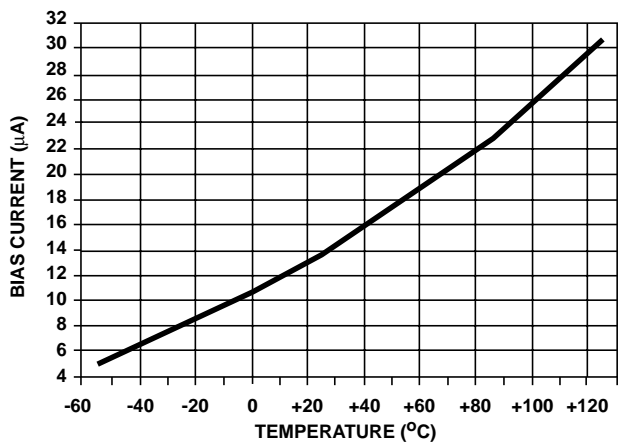

FIGURE 20. BIAS CURRENT vs TEMPERATURE

Typical Performance Curves $V_{SUPPLY} = \pm 5V$, $T_A = 25^\circ C$, $R_L = 100\Omega$. Unless Otherwise Specified. (Continued)

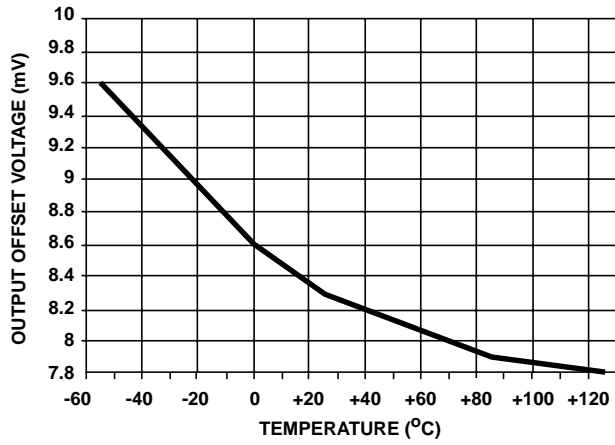

FIGURE 21. OFFSET VOLTAGE vs TEMPERATURE

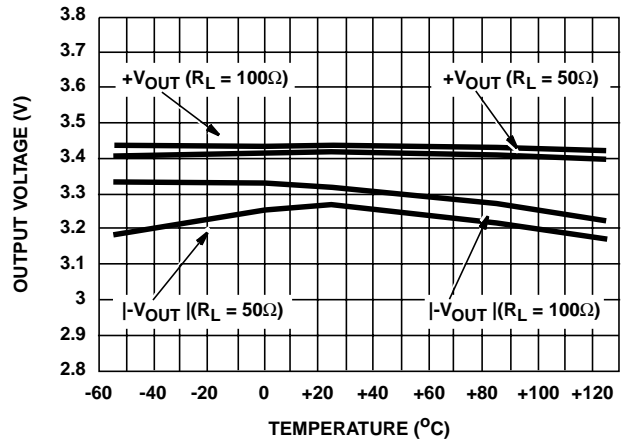

FIGURE 22. OUTPUT VOLTAGE vs TEMPERATURE

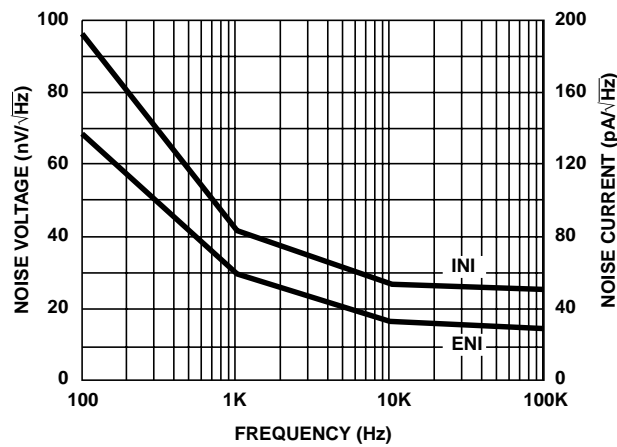

FIGURE 23. INPUT NOISE vs FREQUENCY

PC Board Layout

The frequency response of this buffer depends greatly on the amount of care taken in designing the PC board. **The use of low inductance components such as chip resistors and chip capacitors is strongly recommended, while a solid ground plane is a must!**

Attention should be given to decoupling the power supplies. A large value (10 μ F) tantalum in parallel with a small value (0.1 μ F) chip capacitor works well in most cases.

Terminated microstrip signal lines are recommended at the input and output of the device. Capacitance directly on the output must be minimized, or isolated as discussed in the next section. Removing the GND plane under the output trace helps minimize this capacitance.

An example of a good high frequency layout is the Evaluation Board shown in Figure 25.

Driving Capacitive Loads

Capacitive loads, such as an A/D input, or an improperly terminated transmission line will degrade the buffer's phase margin resulting in frequency response peaking and possible oscillations. In most cases, the oscillation can be avoided by placing a resistor (R_S) in series with the output prior to the capacitance.

Figure 24 details starting points for the selection of this resistor. The points on the curve indicate the R_S and C_L combinations for the optimum bandwidth, stability, and settling time, but experimental fine tuning is recommended. Picking a point above or to the right of the curve yields an overdamped response, while points below or left of the curve indicate areas of underdamped performance.

R_S and C_L form a low pass network at the output, thus limiting system bandwidth well below the buffer bandwidth of 750MHz. By decreasing R_S as C_L increases (as illustrated in Figure 24), the maximum bandwidth is obtained without sacrificing stability. Even so, bandwidth does decrease as you move to the right along the curve.

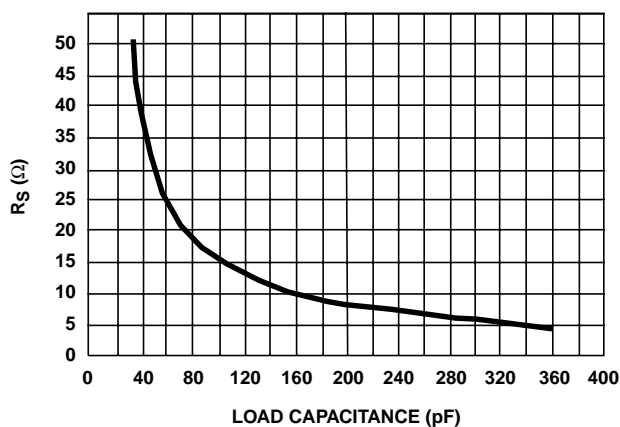

FIGURE 24. RECOMMENDED SERIES OUTPUT RESISTOR vs LOAD CAPACITANCE

Evaluation Board

The performance of this buffer may be evaluated using the HFA1110 Evaluation Board. The layout and schematic of the board are shown in Figure 25.

To order evaluation boards, please contact your local sales office.

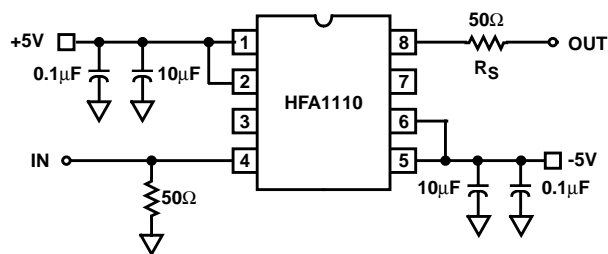
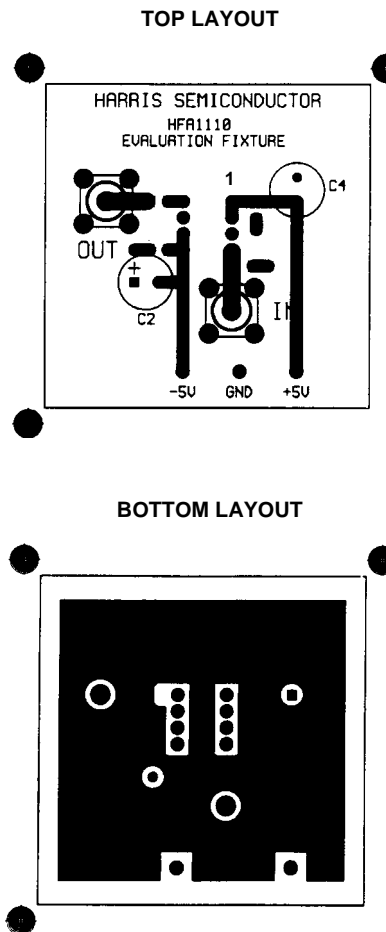

FIGURE 25. EVALUATION BOARD SCHEMATIC AND LAYOUT

HFA1110/883

TABLE 3. TYPICAL PERFORMANCE SPECIFICATIONS

Device Characterized at: $V_{SUPPLY} = \pm 5V$, $R_L = 100\Omega$, Unless Otherwise Specified

PARAMETER	CONDITIONS	TEMPERATURE (°C)	TYPICAL	UNITS
Output Offset Voltage (See Note)	$V_{CM} = 0V$	25	8	mV
Average Offset Voltage Drift	Versus Temperature	Full	10	$\mu V/^\circ C$
Power Supply Rejection Ratio	$\Delta V_{SUP} = \pm 1.25V$	25	45	dB
Input Current (See Note)	$V_{CM} = 0V$	25	10	μA
Input Resistance	$\Delta V_{CM} = \pm 2V$	25	50	$k\Omega$
Input Capacitance		25	2.2	pF
Input Noise Voltage (See Note)	$f = 100kHz$	25	14	nV/\sqrt{Hz}
Input Noise Current (See Note)	$f = 100kHz$	25	51	pA/\sqrt{Hz}
Input Common Mode Range		Full	± 2.8	V
Gain	$V_{OUT} = 2V_{P-P}$	25	0.99	V/V
DC Non-Linearity (See Note)	$\pm 2V$ Full Scale	25	0.003	%
Output Voltage (See Note)	$R_L = 100\Omega$	25	± 3.3	V
	$R_L = 100\Omega$	Full	± 3.0	V
Output Current (See Note)	$R_L = 50\Omega$	25 to 125	± 60	mA
	$R_L = 50\Omega$	-55 to 0	± 50	mA
DC Closed Loop Output Resistance		25	0.3	Ω
Quiescent Supply Current (See Note)	$R_L = Open$	Full	24	mA
-3dB Bandwidth (See Note)	$V_{OUT} = 200mV_{P-P}$	25	750	MHz
Slew Rate	$V_{OUT} = 5V_{P-P}$	25	1250	V/ μs
Full Power Bandwidth (See Note)	$V_{OUT} = 4V_{P-P}$	25	150	MHz
Gain Flatness (See Note)	To 30MHz	25	± 0.01	dB
	To 50MHz	25	± 0.02	dB
	To 100MHz	25	± 0.03	dB
Linear Phase Deviation (See Note)	To 100MHz	25	± 0.3	Degrees
2nd Harmonic Distortion (See Note)	30MHz, $V_{OUT} = 2V_{P-P}$	25	-72	dBc
	50MHz, $V_{OUT} = 2V_{P-P}$	25	-57	dBc
	100MHz, $V_{OUT} = 2V_{P-P}$	25	-42	dBc
3rd Harmonic Distortion (See Note)	30MHz, $V_{OUT} = 2V_{P-P}$	25	-80	dBc
	50MHz, $V_{OUT} = 2V_{P-P}$	25	-74	dBc
	100MHz, $V_{OUT} = 2V_{P-P}$	25	-51	dBc
3rd Order Intercept (See Note)	100MHz	25	30	dBm
	300MHz	25	10	dBm
1dB Gain Compression	100MHz	25	14	dBm
	150MHz	25	10	dBm
	200MHz	25	7	dBm
Reverse Isolation (S_{12}) (See Note)	40MHz	25	-70	dB
	100MHz	25	-60	dB
	600MHz	25	-27	dB
Rise and Fall Time	$V_{OUT} = 0.5V_{P-P}$	25	600	ps
Overshoot (See Note)	$V_{OUT} = 0.5V_{P-P}$, Input $t_R/t_F = 600ps$	25	9	%
Differential Gain	$R_L = 75\Omega$, NTSC	25	0.04	%
Differential Phase	$R_L = 75\Omega$, NTSC	25	0.025	Degrees

NOTE: See Typical Performance Curves for more information.

Die Characteristics

DIE DIMENSIONS:

63 x 44 x 19 mils ± 1 mils
1600 x 1130 x 483µm ± 25.4µm

METALLIZATION:

Type: Metal 1: AlCu(2%)/TiW
Thickness: Metal 1: 8kÅ ±0.4kÅ
Type: Metal 2: AlCu(2%)
Thickness: Metal 2: 16kÅ ±0.8kÅ

GLASSIVATION:

Type: Nitride
Thickness: 4kÅ ±0.5kÅ

WORST CASE CURRENT DENSITY:

2.0 x 10⁵ A/cm² at 47.5mA

TRANSISTOR COUNT:

52

SUBSTRATE POTENTIAL (Powered Up):

Floating (Recommend Connection to V-)

Metallization Mask Layout

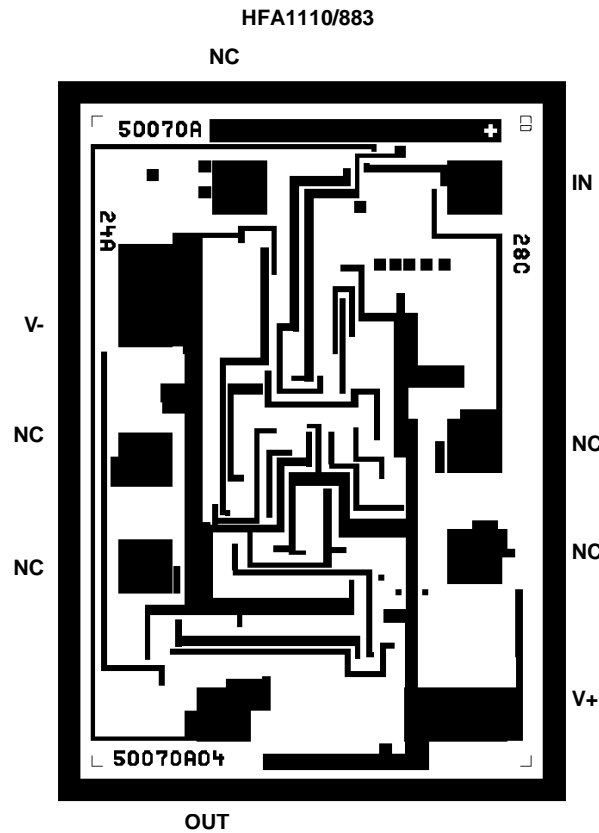

Ceramic Dual-In-Line Frit Seal Packages (CERDIP)

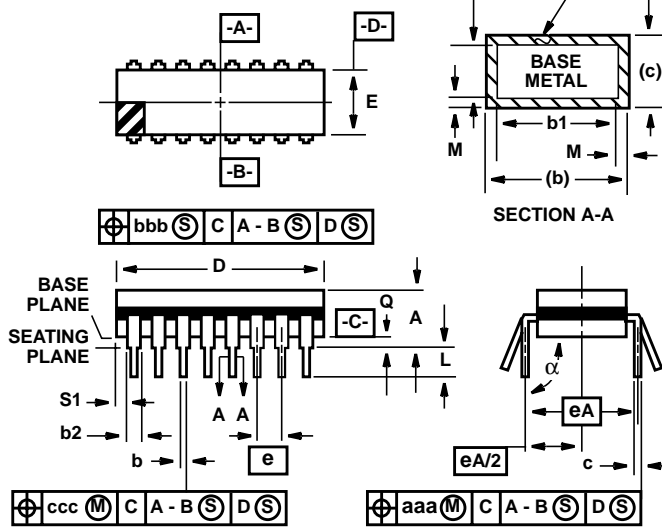

**F8.3A MIL-STD-1835 GDIP1-T8 (D-4, CONFIGURATION A)
8 LEAD CERAMIC DUAL-IN-LINE FRIT SEAL PACKAGE**

SYMBOL	INCHES		MILLIMETERS		NOTES
	MIN	MAX	MIN	MAX	
A	-	0.200	-	5.08	-
b	0.014	0.026	0.36	0.66	2
b1	0.014	0.023	0.36	0.58	3
b2	0.045	0.065	1.14	1.65	-
b3	0.023	0.045	0.58	1.14	4
c	0.008	0.018	0.20	0.46	2
c1	0.008	0.015	0.20	0.38	3
D	-	0.405	-	10.29	5
E	0.220	0.310	5.59	7.87	5
e	0.100 BSC		2.54 BSC		-
eA	0.300 BSC		7.62 BSC		-
eA/2	0.150 BSC		3.81 BSC		-
L	0.125	0.200	3.18	5.08	-
Q	0.015	0.060	0.38	1.52	6
S1	0.005	-	0.13	-	7
α	90°	105°	90°	105°	-
aaa	-	0.015	-	0.38	-
bbb	-	0.030	-	0.76	-
ccc	-	0.010	-	0.25	-
M	-	0.0015	-	0.038	2, 3
N	8		8		8

NOTES:

1. Index area: A notch or a pin one identification mark shall be located adjacent to pin one and shall be located within the shaded area shown. The manufacturer's identification shall not be used as a pin one identification mark.
2. The maximum limits of lead dimensions b and c or M shall be measured at the centroid of the finished lead surfaces, when solder dip or tin plate lead finish is applied.
3. Dimensions b1 and c1 apply to lead base metal only. Dimension M applies to lead plating and finish thickness.
4. Corner leads (1, N, N/2, and N/2+1) may be configured with a partial lead paddle. For this configuration dimension b3 replaces dimension b2.
5. This dimension allows for off-center lid, meniscus, and glass overrun.
6. Dimension Q shall be measured from the seating plane to the base plane.
7. Measure dimension S1 at all four corners.
8. N is the maximum number of terminal positions.
9. Dimensioning and tolerancing per ANSI Y14.5M - 1982.
10. Controlling dimension: INCH.

Rev. 0 4/94

All Intersil semiconductor products are manufactured, assembled and tested under **ISO9000** quality systems certification.

Intersil products are sold by description only. Intersil Corporation reserves the right to make changes in circuit design and/or specifications at any time without notice. Accordingly, the reader is cautioned to verify that data sheets are current before placing orders. Information furnished by Intersil is believed to be accurate and reliable. However, no responsibility is assumed by Intersil or its subsidiaries for its use; nor for any infringements of patents or other rights of third parties which may result from its use. No license is granted by implication or otherwise under any patent or patent rights of Intersil or its subsidiaries.

For information regarding Intersil Corporation and its products, see web site <http://www.intersil.com>

Sales Office Headquarters

NORTH AMERICA
Intersil Corporation
P. O. Box 883, Mail Stop 53-204
Melbourne, FL 32902
TEL: (321) 724-7000
FAX: (321) 724-7240

EUROPE
Intersil SA
Mercure Center
100, Rue de la Fusee
1130 Brussels, Belgium
TEL: (32) 2.724.2111
FAX: (32) 2.724.22.05

ASIA
Intersil (Taiwan) Ltd.
Taiwan Limited
7F-6, No. 101 Fu Hsing North Road
Taipei, Taiwan
Republic of China
TEL: (886) 2 2716 9310
FAX: (886) 2 2715 3029