

Designer's™ Data Sheet
Surface Mount Silicon Zener Diodes
Plastic SOD-123 Package

**MMSZ5221BT1
SERIES**

Three complete series of Zener Diodes are offered in the convenient, surface mount plastic SOD-123 package. These devices provide a convenient alternative to the leadless 34 package style.

- 500 mW Rating on FR-4 or FR-5 Board
- Package Designed for Optimal Automated Board Assembly
- Corrosion Resistant Finish, Easily Solderable
- ESD Rating of Class 3 (exceeding 16 kV) per the Human Body Model
- Small Package Size for High Density Applications
- Available in 8 mm Tape and Reel
Add "T1" to the device number to order the 7 inch/3000 unit reel.
Add "T3" to the device number to order the 13 inch/10,000 unit reel.
- Wafer Fab Location: Phoenix, Arizona
Assembly/Test Location: Seremban, Malaysia

**PLASTIC SURFACE
MOUNT
ZENER DIODES
500 MILLIWATTS
1.8–91 VOLTS**



**1: CATHODE
2: ANODE**

MMSZ5221BT1 thru MMSZ5270BT1

- General Purpose, Medium Current
- Wide Voltage Range — 2.4 to 91 Volts



**CASE 425, STYLE 1
PLASTIC**

DEVICE RATING ($T_A = 25^\circ\text{C}$ unless otherwise noted)

Rating	Symbol	Value	Unit
Power Dissipation on FR-4 or FR-5 Board [1] Derate above $T_L = 75^\circ\text{C}$	P_D —	500 6.7	mW mW/ $^\circ\text{C}$
Thermal Resistance Junction to Lead [2] Thermal Resistance Junction to Ambient [2]	$R_{\theta JL}$ $R_{\theta JA}$	150 340	$^\circ\text{C/W}$
Junction Temperature Range	T_J	-55 to +150	$^\circ\text{C}$
Storage Temperature Range	T_{stg}	-55 to +150	$^\circ\text{C}$
Lead Solder Temperature – Maximum (10 sec. duration)	—	260	$^\circ\text{C}$

[1] FR-4 or FR-5 = 3.5 x 1.5 inches, using the Motorola minimum recommended footprint as shown in Figure 11.

[2] Thermal Resistance measurement obtained via Infrared Scan Method

Designer's Data for "Worst Case" Conditions — The Designer's Data Sheet permits the design of most circuits entirely from the information presented. Limit curves — representing boundaries on device characteristics — are given to facilitate "worst case" design.

Designer's is a trademark of Motorola, Inc.

Thermal Clad is a trademark of the Bergquist Company.

Preferred devices are Motorola recommended choices for future use and best overall value.

MMSZ5221BT1 Series

ELECTRICAL CHARACTERISTICS ($T_A = 25^\circ\text{C}$ unless otherwise noted [1]), ($V_F = 0.9\text{ V Max. @ } I_F = 10\text{ mA}$ for all types)

Type Number	Marking	Zener Voltage $V_Z @ I_{ZT}$ Volts [1] [2]			Test Current I_{ZT} mA	Max Zener Impedance [3]		Max Reverse Leakage Current $I_R @ V_R$ μA	Test Voltage V_R Volts
		Nom	Min	Max		$Z_{ZT} @ I_Z = I_{ZT}$ Ω	$Z_{ZK} @ I_{ZK} = 0.25\text{ mA}$ Ω		
MMSZ5221BT1	C1	2.4	2.28	2.52	20	30	1200	100	1
MMSZ5222BT1	C2	2.5	2.38	2.63	20	30	1250	100	1
MMSZ5223BT1	C3	2.7	2.57	2.84	20	30	1300	75	1
MMSZ5224BT1	C4	2.8	2.66	2.94	20	30	1400	75	1
MMSZ5225BT1	C5	3.0	2.85	3.15	20	30	1600	50	1
MMSZ5226BT1	D1	3.3	3.14	3.47	20	28	1600	25	1
MMSZ5227BT1	D2	3.6	3.42	3.78	20	24	1700	15	1
MMSZ5228BT1	D3	3.9	3.71	4.10	20	23	1900	10	1
MMSZ5229BT1	D4	4.3	4.09	4.52	20	22	2000	5	1
MMSZ5230BT1	D5	4.7	4.47	4.94	20	19	1900	5	2
MMSZ5231BT1	E1	5.1	4.85	5.36	20	17	1600	5	2
MMSZ5232BT1	E2	5.6	5.32	5.88	20	11	1600	5	3
MMSZ5233BT1	E3	6.0	5.70	6.30	20	7	1600	5	3.5
MMSZ5234BT1	E4	6.2	5.89	6.51	20	7	1000	5	4
MMSZ5235BT1	E5	6.8	6.46	7.14	20	5	750	3	5
MMSZ5236BT1	F1	7.5	7.13	7.88	20	6	500	3	6
MMSZ5237BT1	F2	8.2	7.79	8.61	20	8	500	3	6.5
MMSZ5238BT1	F3	8.7	8.27	9.14	20	8	600	3	6.5
MMSZ5239BT1	F4	9.1	8.65	9.56	20	10	600	3	7
MMSZ5240BT1	F5	10	9.50	10.50	20	17	600	3	8
MMSZ5241BT1	H1	11	10.45	11.55	20	22	600	2	8.4
MMSZ5242BT1	H2	12	11.40	12.60	20	30	600	1	9.1
MMSZ5243BT1	H3	13	12.35	13.65	9.5	13	600	0.5	9.9
MMSZ5244BT1	H4	14	13.30	14.70	9.0	15	600	0.1	10
MMSZ5245BT1	H5	15	14.25	15.75	8.5	16	600	0.1	11
MMSZ5246BT1	J1	16	15.20	16.80	7.8	17	600	0.1	12
MMSZ5247BT1	J2	17	16.15	17.85	7.4	19	600	0.1	13
MMSZ5248BT1	J3	18	17.10	18.90	7.0	21	600	0.1	14
MMSZ5249BT1	J4	19	18.05	19.95	6.6	23	600	0.1	14
MMSZ5250BT1	J5	20	19.00	21.00	6.2	25	600	0.1	15
MMSZ5251BT1	K1	22	20.90	23.10	5.6	29	600	0.1	17
MMSZ5252BT1	K2	24	22.80	25.20	5.2	33	600	0.1	18
MMSZ5253BT1	K3	25	23.75	26.25	5.0	35	600	0.1	19
MMSZ5254BT1	K4	27	25.65	28.35	4.6	41	600	0.1	21
MMSZ5255BT1	K5	28	26.60	29.40	4.5	44	600	0.1	21

[1] Nominal zener voltage is measured with the device junction in thermal equilibrium at $T_L = 30^\circ\text{C} \pm 1^\circ\text{C}$.

[2] All part numbers shown indicate a V_Z tolerance of $\pm 5\%$.

[3] Z_{ZT} and Z_{ZK} are measured by dividing the AC voltage drop across the device by the AC current applied. The specified limits are for $I_{Z(AC)} = 0.1 I_{Z(DC)}$, with the AC frequency = 1 kHz.

MMSZ5221BT1 Series

ELECTRICAL CHARACTERISTICS ($T_A = 25^\circ\text{C}$ unless otherwise noted ^[1]), ($V_F = 0.9\text{ V Max. @ } I_F = 10\text{ mA}$ for all types)

Type Number	Marking	Zener Voltage $V_Z @ I_{ZT}$ Volts [1] [2]			Test Current I_{ZT} mA	Max Zener Impedance [3]		Max Reverse Leakage Current $I_R @ V_R$ μA	Test Voltage V_R Volts
		Nom	Min	Max		$Z_{ZT} @ I_Z = I_{ZT}$ Ω	$Z_{ZK} @ I_{ZK} = 0.25\text{ mA}$ Ω		
MMSZ5256BT1	M1	30	28.50	31.50	4.2	49	600	0.1	23
MMSZ5257BT1	M2	33	31.35	34.65	3.8	58	700	0.1	25
MMSZ5258BT1	M3	36	34.20	37.80	3.4	70	700	0.1	27
MMSZ5259BT1	M4	39	37.05	40.95	3.2	80	800	0.1	30
MMSZ5260BT1	M5	43	40.85	45.15	3.0	93	900	0.1	33
MMSZ5261BT1	N1	47	44.65	49.35	2.7	105	1000	0.1	36
MMSZ5262BT1	N2	51	48.45	53.55	2.5	125	1100	0.1	39
MMSZ5263BT1	N3	56	53.20	58.80	2.2	150	1300	0.1	43
MMSZ5264BT1	N4	60	57.00	63.00	2.1	170	1400	0.1	46
MMSZ5265BT1	N5	62	58.90	65.10	2.0	185	1400	0.1	47
MMSZ5266BT1	P1	68	64.60	71.40	1.8	230	1600	0.1	52
MMSZ5267BT1	P2	75	71.25	78.75	1.7	270	1700	0.1	56
MMSZ5268BT1	P3	82	77.90	86.10	1.5	330	2000	0.1	62
MMSZ5269BT1	P4	87	82.65	91.35	1.4	370	2200	0.1	68
MMSZ5270BT1	P5	91	86.45	95.55	1.4	400	2300	0.1	69

^[1] Nominal zener voltage is measured with the device junction in thermal equilibrium at $T_L = 30^\circ\text{C} \pm 1^\circ\text{C}$.

^[2] All part numbers shown indicate a V_Z tolerance of $\pm 5\%$.

^[3] Z_{ZT} and Z_{ZK} are measured by dividing the AC voltage drop across the device by the AC current applied. The specified limits are for $I_{Z(AC)} = 0.1 I_{Z(DC)}$, with the AC frequency = 1 kHz.

MMSZ5221BT1 Series

TYPICAL CHARACTERISTICS

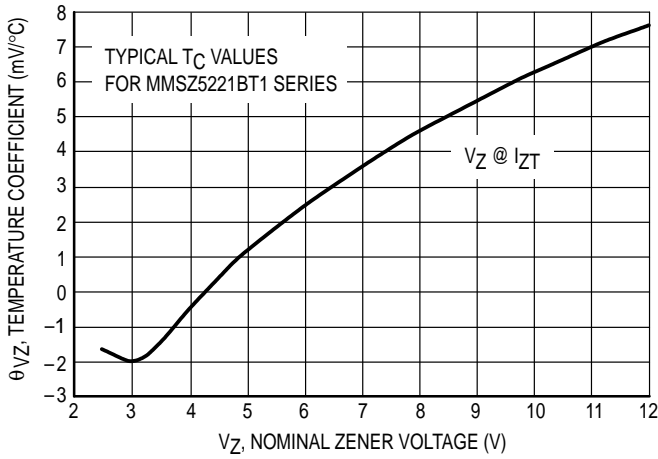

Figure 1. Temperature Coefficients (Temperature Range -55°C to +150°C)

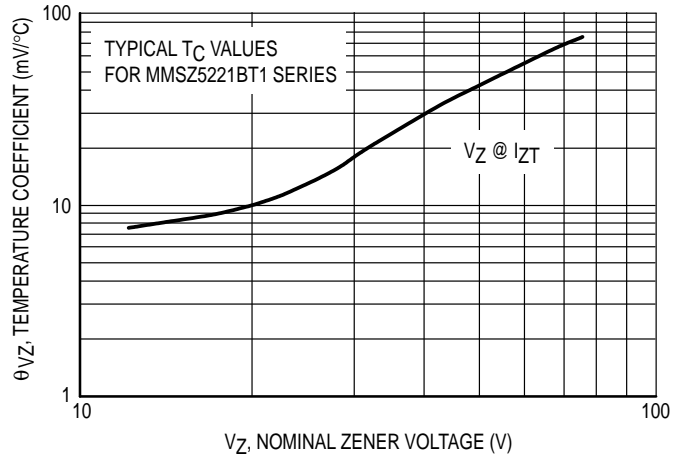

Figure 2. Temperature Coefficients (Temperature Range -55°C to +150°C)

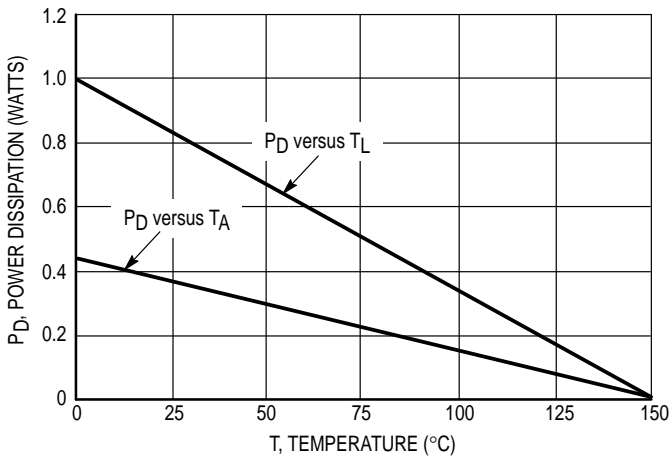

Figure 3. Steady State Power Derating

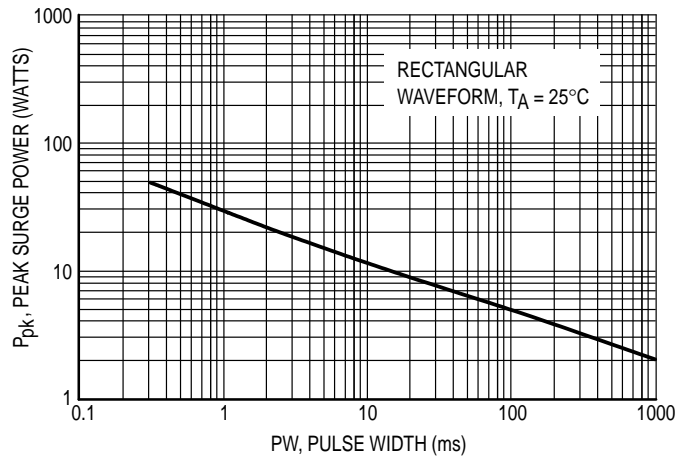

Figure 4. Maximum Nonrepetitive Surge Power

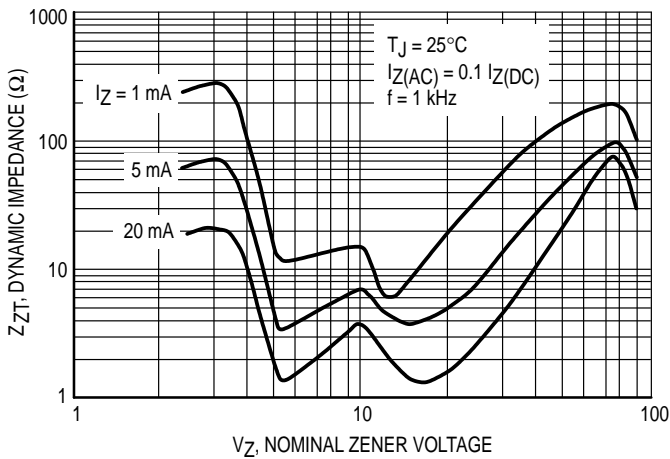

Figure 5. Effect of Zener Voltage on Zener Impedance

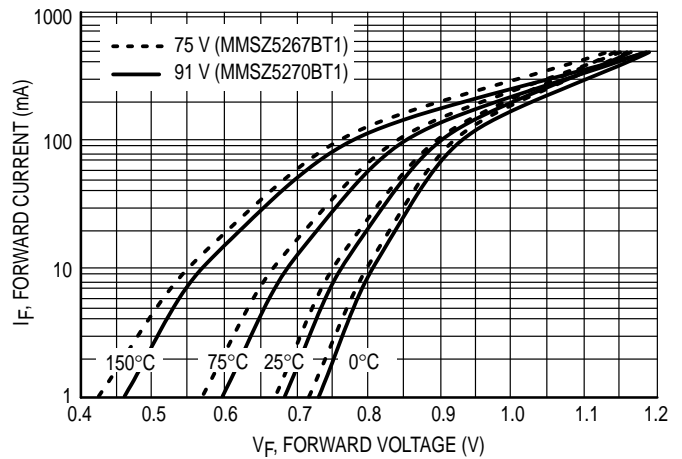

Figure 6. Typical Forward Voltage

MMSZ5221BT1 Series

TYPICAL CHARACTERISTICS

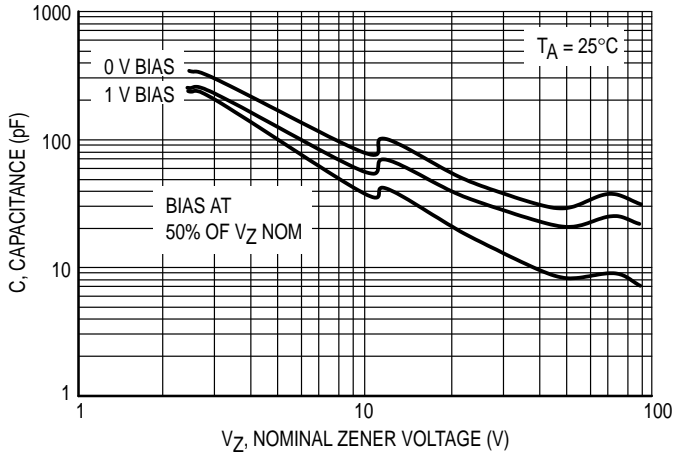

Figure 7. Typical Capacitance

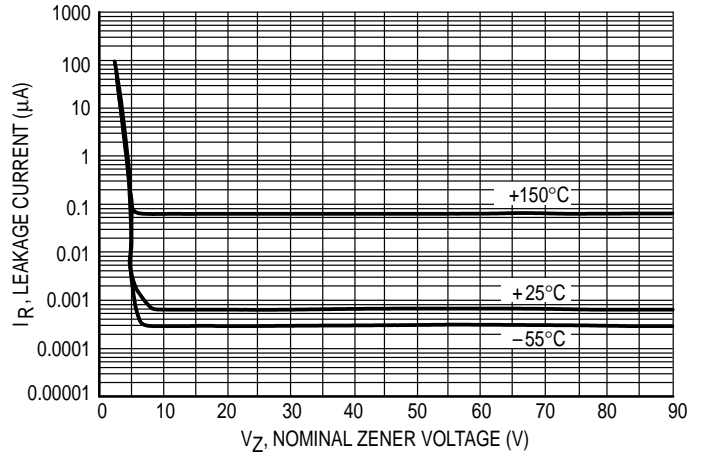

Figure 8. Typical Leakage Current

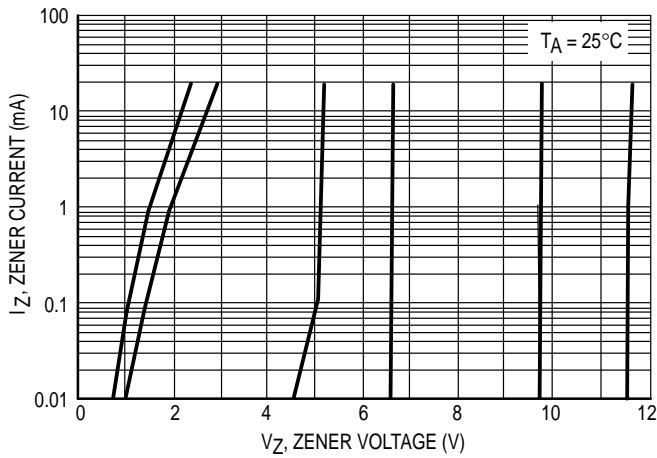

Figure 9. Zener Voltage versus Zener Current (V_Z Up to 12 V)

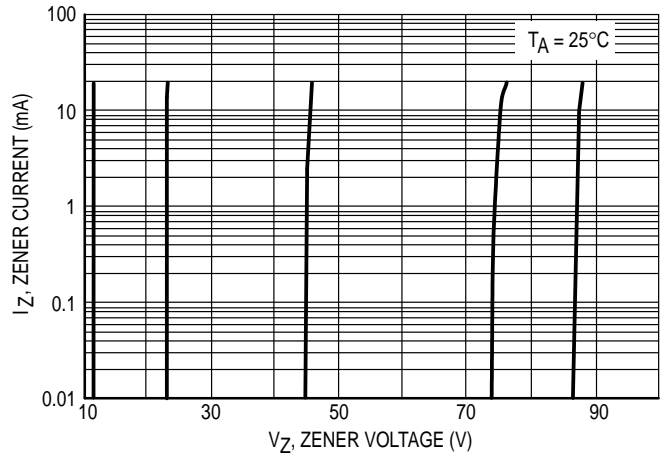

Figure 10. Zener Voltage versus Zener Current (12 V to 91 V)

MMSZ5221BT1 Series

INFORMATION FOR USING THE SOD-123 SURFACE MOUNT PACKAGE

MINIMUM RECOMMENDED FOOTPRINTS FOR SURFACE MOUNT APPLICATIONS

Surface mount board layout is a critical portion of the total design. The footprint for the semiconductor packages must be the correct size to ensure proper solder connection interface between the board and the package.

The minimum recommended footprint for the SOD-123 is shown at the right.

The SOD-123 package can be used on existing surface mount boards which have been designed for the leadless 34 package style. The footprint compatibility makes conversion from leadless 34 to SOD-123 straightforward.

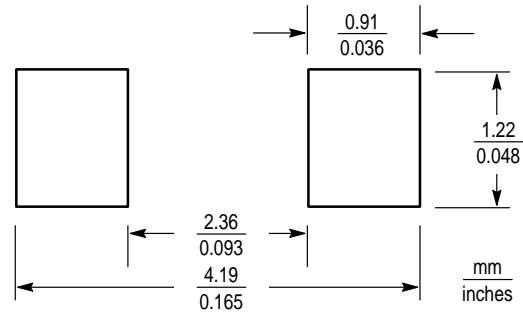

Figure 11. Minimum Recommended Footprint

SOD-123 POWER DISSIPATION

The power dissipation of the SOD-123 is a function of the pad size. This can vary from the minimum pad size for soldering to a pad size given for maximum power dissipation. Power dissipation for a surface mount device is determined by $T_{J(max)}$, the maximum rated junction temperature of the die, $R_{\theta JA}$, the thermal resistance from the device junction to ambient; and the operating temperature, T_A . Using the values provided on the data sheet for the SOD-123 package, P_D can be calculated as follows:

$$P_D = \frac{T_{J(max)} - T_A}{R_{\theta JA}}$$

The values for the equation are found in the maximum

ratings table on the data sheet. Substituting these values into the equation for an ambient temperature T_A of 25°C, one can calculate the power dissipation of the device which in this case is 0.37 watts.

$$P_D = \frac{150^\circ\text{C} - 25^\circ\text{C}}{340^\circ\text{C/W}} = 0.37 \text{ watts}$$

The 340°C/W for the SOD-123 package assumes using recommended footprint shown on FR-4 glass epoxy printed circuit board. Another alternative is to use a ceramic substrate or an aluminum core board such as Thermal Clad™. By using an aluminum core board material such as Thermal Clad, the power dissipation can be doubled using the same footprint.

GENERAL SOLDERING PRECAUTIONS

The melting temperature of solder is higher than the rated temperature of the device. When the entire device is heated to a high temperature, failure to complete soldering within a short time could result in device failure. Therefore, the following items should always be observed in order to minimize the thermal stress to which the devices are subjected.

- Always preheat the device.
- The delta temperature between the preheat and soldering should be 100°C or less.*
- When preheating and soldering, the temperature of the leads and the case must not exceed the maximum temperature ratings as shown on the data sheet. When using infrared heating with the reflow soldering method, the difference shall be a maximum of 10°C.

- The soldering temperature and time shall not exceed 260°C for more than 10 seconds.
- When shifting from preheating to soldering, the maximum temperature gradient shall be 5°C or less.
- After soldering has been completed, the device should be allowed to cool naturally for at least three minutes. Gradual cooling should be used as the use of forced cooling will increase the temperature gradient and result in latent failure due to mechanical stress.
- Mechanical stress or shock should not be applied during cooling

* Soldering a device without preheating can cause excessive thermal shock and stress which can result in damage to the device.

Zener Voltage Regulator Diodes — Surface Mounted

500 mW SOD-123

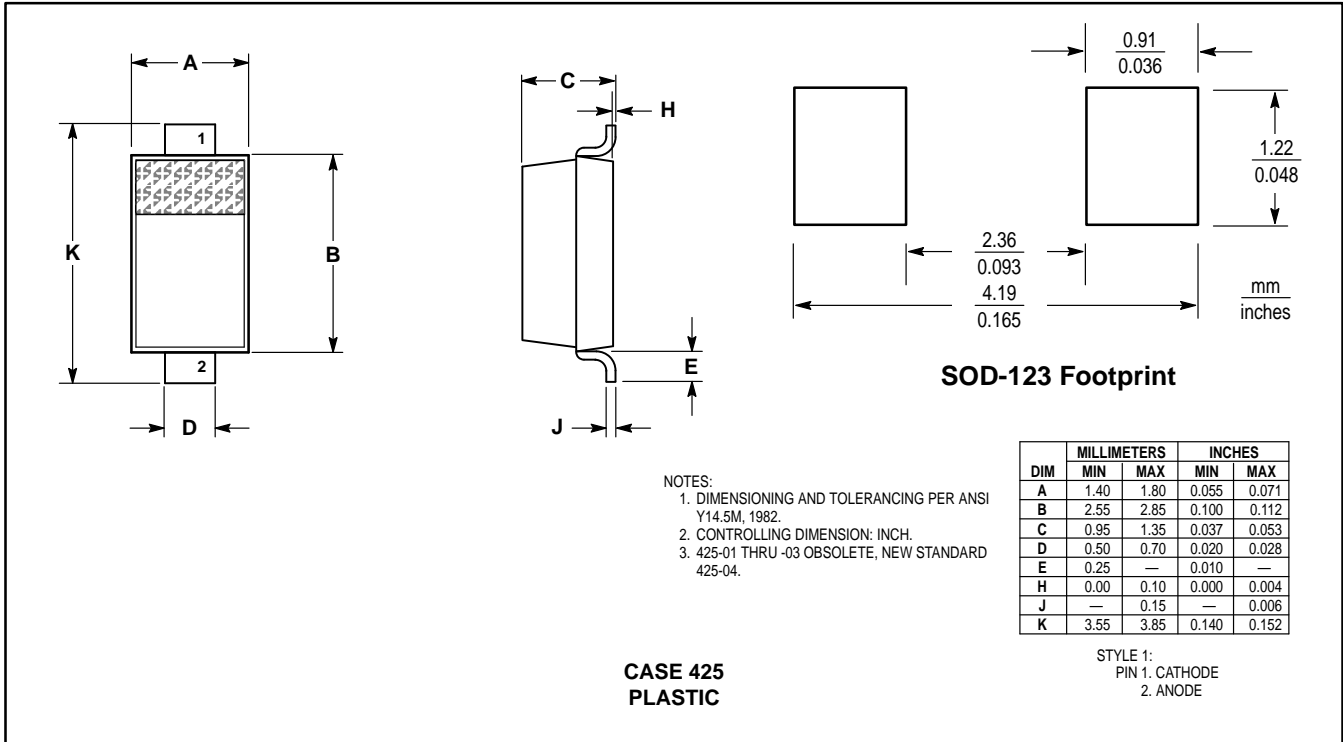

(Refer to Section 10 for Surface Mount, Thermal Data and Footprint Information.)

MULTIPLE PACKAGE QUANTITY (MPQ) REQUIREMENTS

Package Option	Type No. Suffix	MPQ (Units)
Tape and Reel	T1(1)	3K
Tape and Reel	T3(2)	10K

NOTE: 1. The numbers on the suffixes indicate the following:
 1. 7" Reel. Cathode lead toward sprocket hole.
 2. 13" Reel. Cathode lead toward sprocket hole.

(Refer to Section 10 for more information on Packaging Specifications.)