

## Micropower Supply Voltage Supervisor (SVS)

### Features

- Precision voltage sensor
- 4.0V trip threshold
- Stable over temperature
- Valid output logic while  $V_{CC} = 0V$ .
- Power-on reset pulse width of 140ms/min. to 560ms/max.
- Low quiescent current (40 $\mu$ A typ.)
- No external components required
- 3-pin SOT23 package

### Applications

- Critical  $\mu$ P and  $\mu$ C power monitoring
- PCI applications
- Memory integrity during "brown-outs"

### Product Description

The CM3404 is a micropower low voltage supply supervisor designed to provide the necessary power-on reset control for microprocessors and memory applications. An internal pull-down resistor on the  $\overline{\text{RESET}}$  output ensures the output remains valid under all supply conditions.

During either a cold-start power-up or a complete power-down sequence, the  $\overline{\text{RESET}}$  output will remain at 0V while the  $V_{CC}$  input voltage is between the threshold level and ground.

When the  $V_{CC}$  input exceeds the preset threshold voltage, an internal timer is triggered and the  $\overline{\text{RESET}}$  output remains active for a minimum of 140ms, at which point the output is taken inactive.

In the event of a "brown-out" condition, the reset output is immediately asserted as soon as the  $V_{CC}$  voltage collapses below the threshold.

Both the trigger threshold and the precision delay pulse are internally controlled and do not require any external components.

### Typical Application Circuit

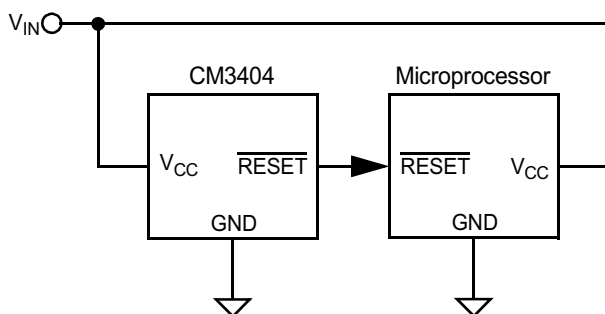

### Simplified Electrical Schematic

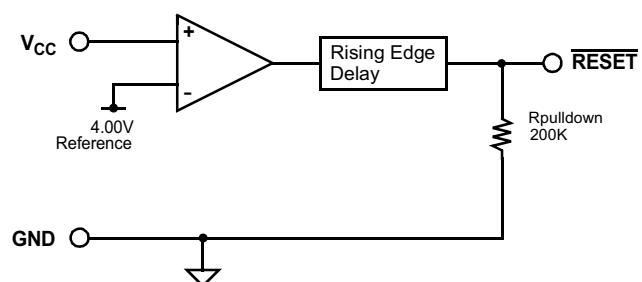

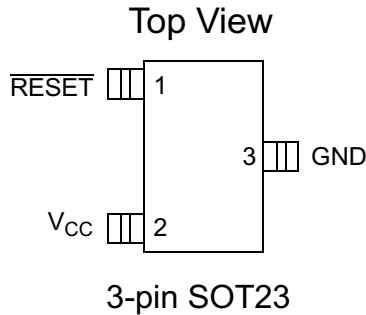
**PACKAGE / PINOUT DIAGRAM**

Note: This drawing is not to scale.

**PIN DESCRIPTIONS**

PIN(S)	NAME	DESCRIPTION
1	$\overline{\text{RESET}}$	Active low reset output. When the sense threshold has been exceeded, the $\overline{\text{RESET}}$ signal will remain active for an additional 140ms (min.) after which it is taken inactive. During a "brown-out" condition $\overline{\text{RESET}}$ will immediately be taken active. Internal circuitry ensures $\overline{\text{RESET}}$ will remain active even when the supply voltage is as low as 0V.
2	VCC	Supply input signal which is monitored by the sense comparator. This input is compared to the 4.00V reference to determine the state of the output.
3	GND	Negative reference for all signals.

**Ordering Information**
**PART NUMBERING INFORMATION**

Pins	Package	Ordering Part Number <sup>2</sup>	Part Marking
3	SOT-23	CM3404-40ST	173Z

Note 1: Parts are shipped in Tape & Reel form unless otherwise specified.



**Specifications**

ABSOLUTE MAXIMUM RATINGS		
PARAMETER	RATING	UNITS
ESD Protection (HBM)	±1500	V
Pin Voltages		
V <sub>CC</sub>	[GND - 0.5] to +6.5	V
RESET	[GND - 0.5] to [V <sub>CC</sub> + 0.5]	V
Storage Temperature Range	-40 to +150	°C
Operating Temperature Range Ambient	-40 to +125	°C

STANDARD OPERATING CONDITIONS		
PARAMETER	VALUE	UNITS
V <sub>CC</sub>	0 to 6.0	V
Ambient Operating Temperature Range	0 to +70	°C

ELECTRICAL OPERATING CHARACTERISTICS <sup>1</sup>						
SYMBOL	PARAMETER	CONDITIONS	MIN	TYP	MAX	UNITS
V <sub>TH</sub>	Sense Threshold	T <sub>A</sub> =25°C	3.93	4.00	4.06	V
			3.89	4.00	4.10	V
I <sub>CC</sub>	Supply Current	No load.		40	80	µA
T <sub>DELAY</sub>	Reset Timeout Delay		140		560	mS
t <sub>PHL</sub>	Propagation Delay when asserting RESET	V <sub>CC</sub> < (V <sub>TH</sub> - 50mV)		0.2	5	µS
R <sub>PULLDOWN</sub>	RESET Pull-Down Impedance	V <sub>CC</sub> < 1.5V		200	500	kΩ
		V <sub>CC</sub> > 1.5V		0.5	3	kΩ
R <sub>PULLUP</sub>	RESET Pull-Up Impedance			0.5	3	kΩ

Note 1: Electrical Operating Characteristics are specified over the Standard Operating Conditions unless specified otherwise.



### Performance Information

CM3404 Typical Characteristics (nominal conditions unless specified otherwise)

#### Transient Operation Description

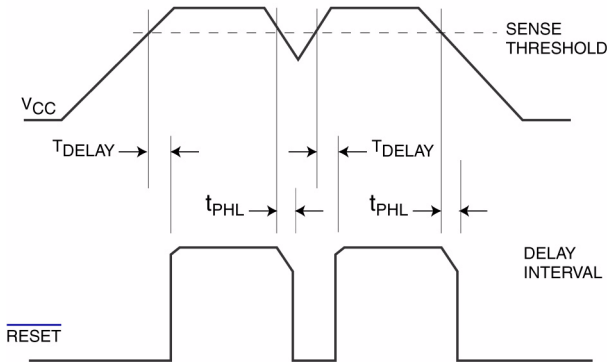

#### Power-up Reset Response

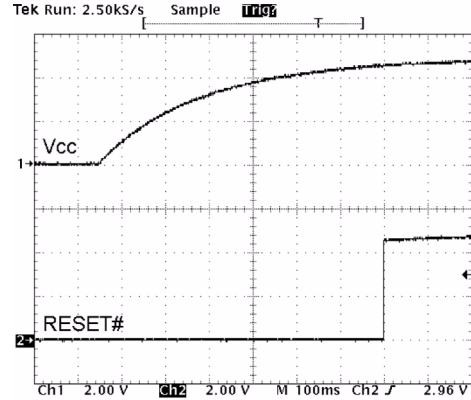

#### Reset Response with Overdrive

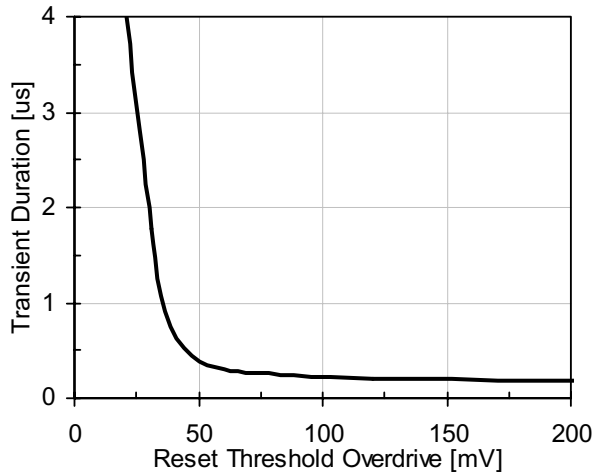

#### Ground Current vs. Voltage

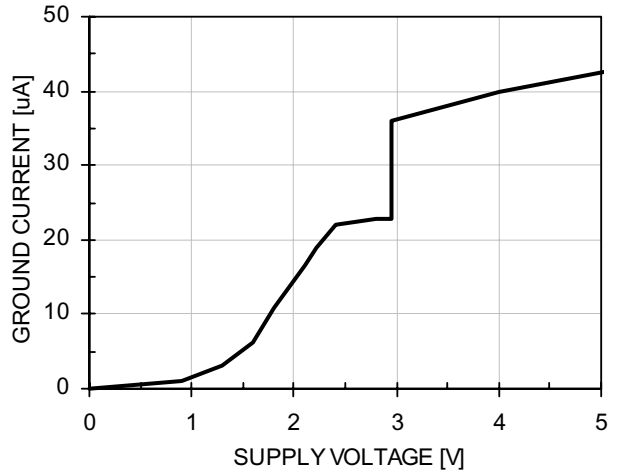

#### Below Trigger RESET\* Pull-down

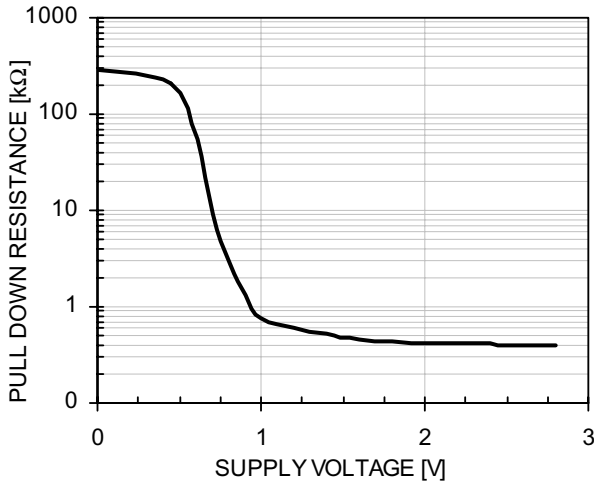

#### Above Trigger RESET\* Pull-up

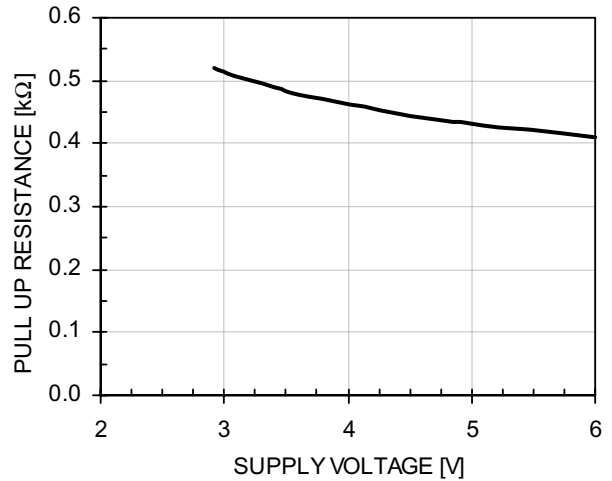



### Performance Information (cont'd)

CM3404 Typical Thermal Characteristics (nominal conditions unless specified otherwise)

**RESET Propagation Delay vs. Temperature**

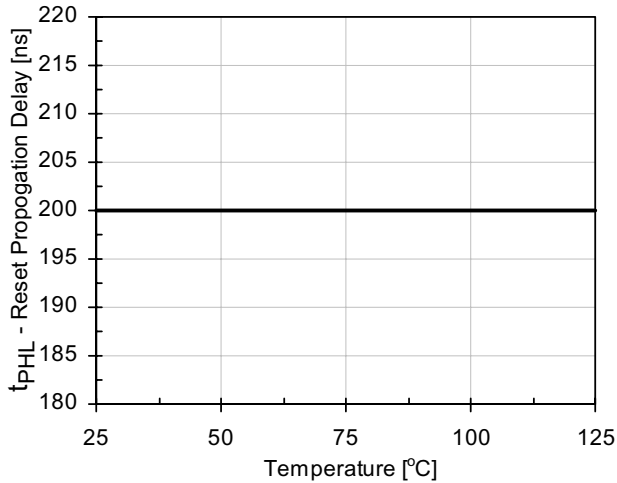

**RESET Release Delay vs. Temperature**

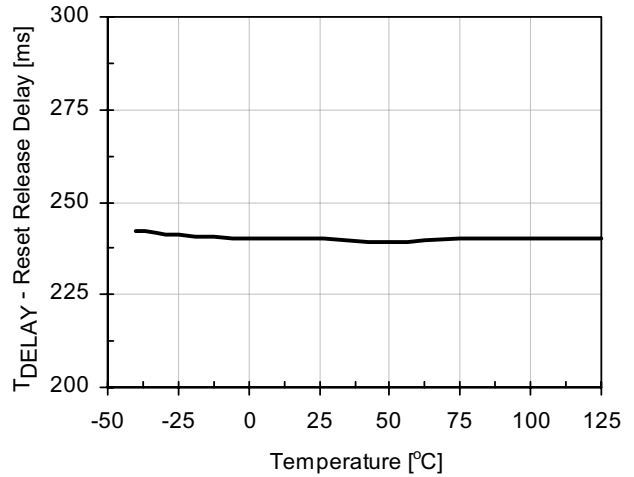

**Ground Current vs. Temperature**

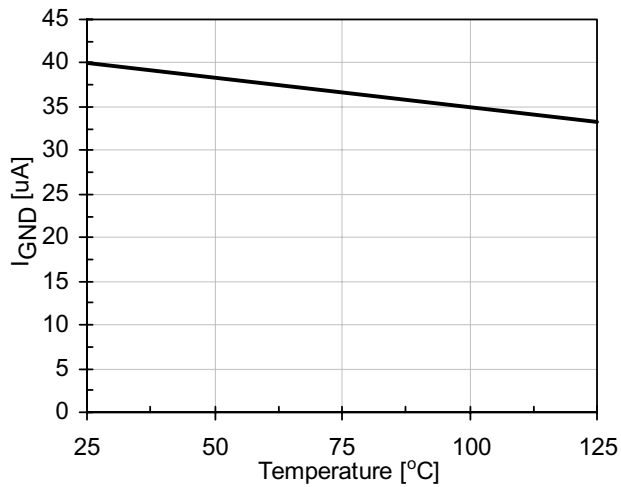

**Threshold Voltage variation vs. Temperature**

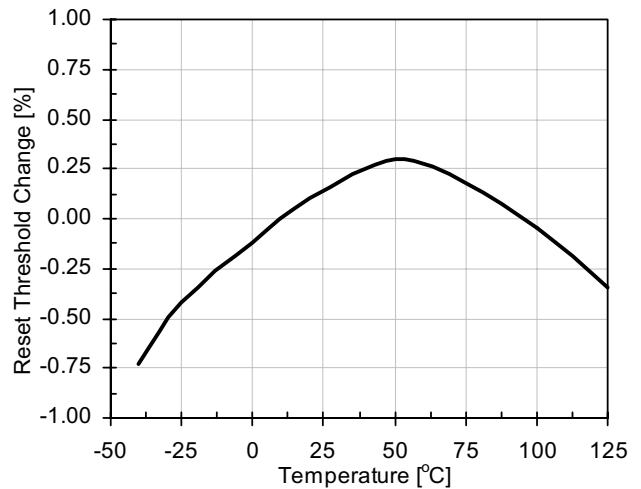



## Mechanical Details

### SOT23-3 Mechanical Specifications

Dimensions for CM3404 devices packaged in 3-pin SOT23 packages are presented below.

For complete information on the SOT23-3 package, see the California Micro Devices SOT23 Package Information document.

PACKAGE DIMENSIONS				
Package	SOT23-3 (JEDEC name is TO-236)			
Pins	3			
Dimensions	Millimeters		Inches	
	Min	Max	Min	Max
A	0.89	1.12	0.0350	0.0441
A1	0.01	0.10	0.0004	0.0039
b	0.30	0.50	0.0118	0.0197
c	0.08	0.20	0.0031	0.0079
D	2.80	3.04	0.1102	0.1197
E	2.10	2.64	0.0827	0.1039
E1	1.20	1.40	0.0472	0.0551
e	0.95 BSC		0.0374 BSC	
e1	1.90 BSC		0.0748 BSC	
L	0.40	0.60	0.0157	0.0236
L1	0.54 REF		0.0213 REF	
# per tape and reel	3000 pieces			
Controlling dimension: millimeters				

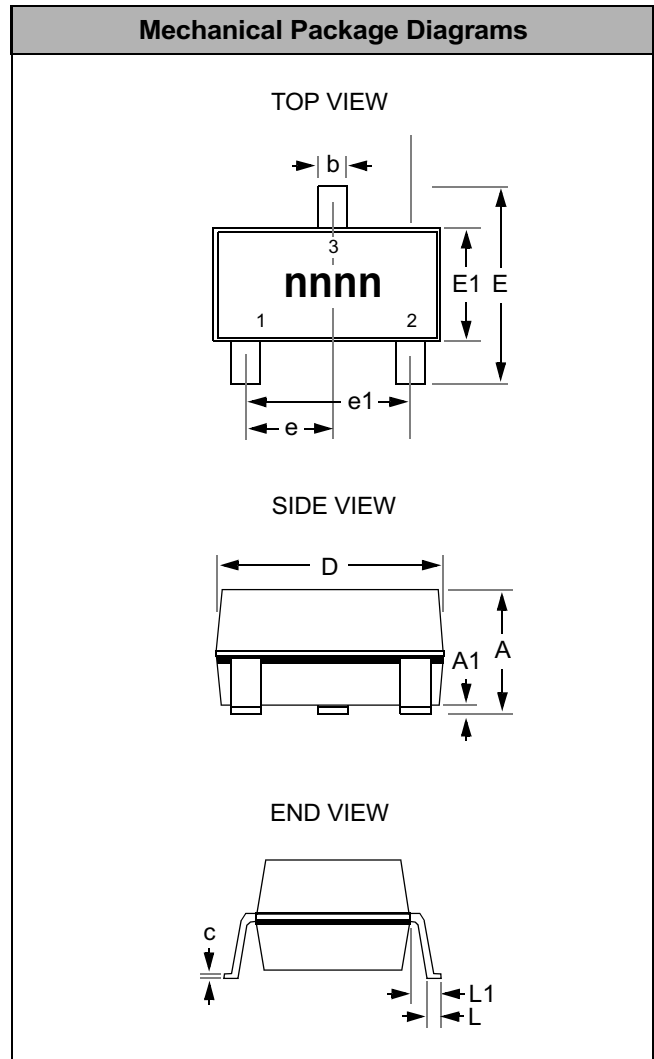

Package Dimensions for SOT23-3.