

Dual Schottky Barrier Diodes

Application circuit designs are moving toward the consolidation of device count and into smaller packages. The new SOT-363 package is a solution which simplifies circuit design, reduces device count, and reduces board space by putting two discrete devices in one small six-leaded package. The SOT-363 is ideal for low-power surface mount applications where board space is at a premium, such as portable products.

Surface Mount Comparisons:

	SOT-363	SOT-23
Area (mm ²)	4.6	7.6
Max Package P _D (mW)	120	225
Device Count	2	1

Space Savings:

Package	1 × SOT-23	2 × SOT-23
SOT-363	40%	70%

The MBD110DW, MBD330DW, and MBD770DW devices are spin-offs of our popular MMBD101LT1, MMBD301LT1, and MMBD701LT1 SOT-23 devices. They are designed for high-efficiency UHF and VHF detector applications. Readily available to many other fast switching RF and digital applications.

- Extremely Low Minority Carrier Lifetime
- Very Low Capacitance
- Low Reverse Leakage

MBD110DWT1
MBD330DWT1
MBD770DWT1

Motorola Preferred Devices

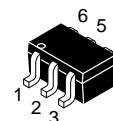

CASE 419B-01, STYLE 6
SOT-363

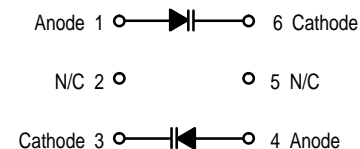

MAXIMUM RATINGS

Rating		Symbol	Value	Unit
Reverse Voltage	MBD110DWT1 MBD330DWT1 MBD770DWT1	V _R	7.0 30 70	Vdc
Forward Power Dissipation T _A = 25°C		P _F	120	mW
Junction Temperature		T _J	-55 to +125	°C
Storage Temperature Range		T _{stg}	-55 to +150	°C

DEVICE MARKING

MBD110DWT1 = M4
MBD330DWT1 = T4
MBD770DWT1 = H5

Preferred devices are Motorola recommended choices for future use and best overall value.

Thermal Clad is a trademark of the Bergquist Company.

MBD110DWT1 MBD330DWT1 MBD770DWT1

ELECTRICAL CHARACTERISTICS ($T_A = 25^\circ\text{C}$ unless otherwise noted)

Characteristic		Symbol	Min	Typ	Max	Unit
Reverse Breakdown Voltage ($I_R = 10 \mu\text{A}$)	MBD110DWT1 MBD330DWT1 MBD770DWT1	$V_{(BR)R}$	7.0 30 70	10 — —	— — —	Volts
Diode Capacitance ($V_R = 0$, $f = 1.0 \text{ MHz}$, Note 1)	MBD110DWT1	C_T	—	0.88	1.0	pF
Total Capacitance ($V_R = 15 \text{ Volts}$, $f = 1.0 \text{ MHz}$) ($V_R = 20 \text{ Volts}$, $f = 1.0 \text{ MHz}$)	MBD330DWT1 MBD770DWT1	C_T	— —	0.9 0.5	1.5 1.0	pF
Reverse Leakage ($V_R = 3.0 \text{ V}$) ($V_R = 25 \text{ V}$) ($V_R = 35 \text{ V}$)	MBD110DWT1 MBD330DWT1 MBD770DWT1	I_R	— — —	0.02 13 9.0	0.25 200 200	μA nAdc nAdc
Noise Figure ($f = 1.0 \text{ GHz}$, Note 2)	MBD110DWT1	NF	—	6.0	—	dB
Forward Voltage ($I_F = 10 \text{ mA}$) ($I_F = 1.0 \text{ mAdc}$) ($I_F = 10 \text{ mA}$) ($I_F = 1.0 \text{ mAdc}$) ($I_F = 10 \text{ mA}$)	MBD110DWT1 MBD330DWT1 MBD770DWT1	V_F	— — — — —	0.5 0.38 0.52 0.42 0.7	0.6 0.45 0.6 0.5 1.0	Vdc

**TYPICAL CHARACTERISTICS
MBD110DWT1**

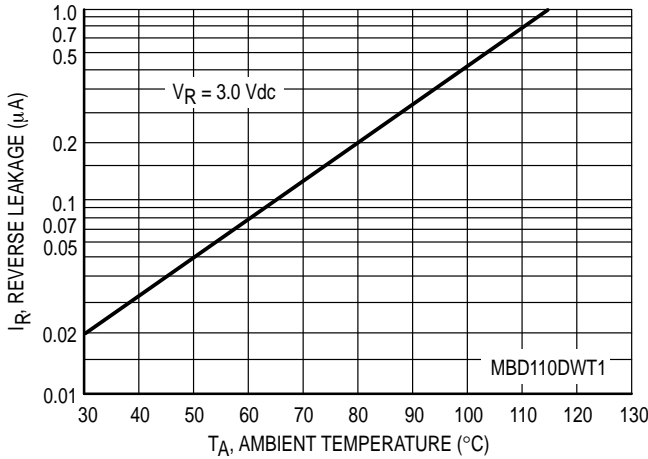

Figure 1. Reverse Leakage

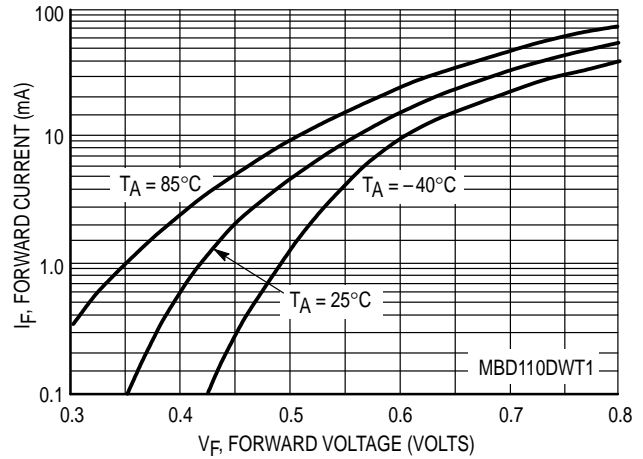

Figure 2. Forward Voltage

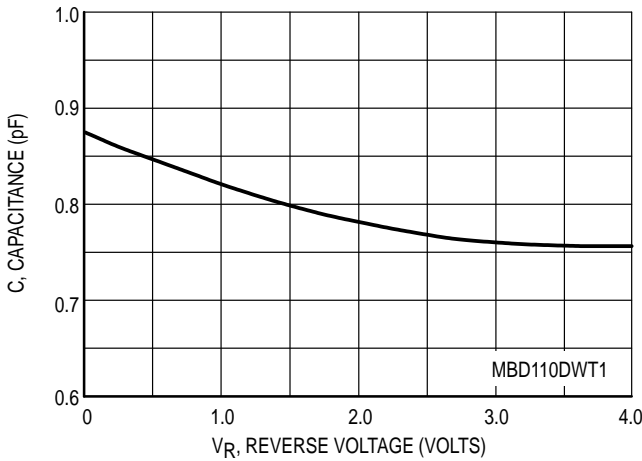

Figure 3. Capacitance

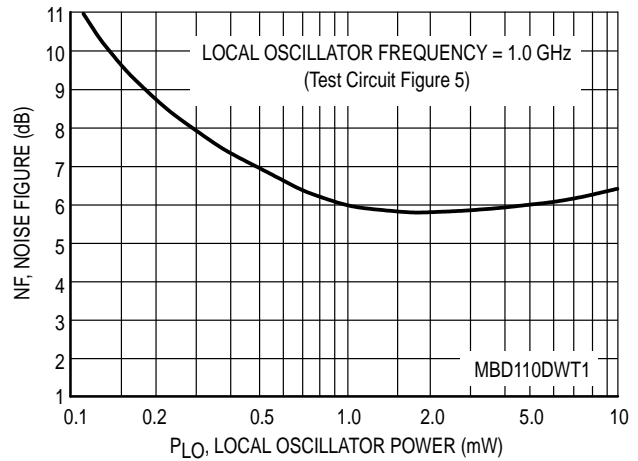

Figure 4. Noise Figure

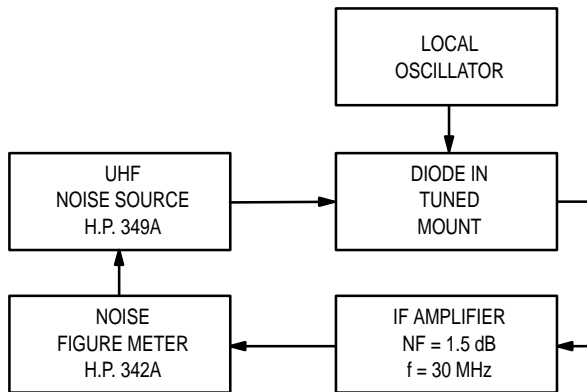

Figure 5. Noise Figure Test Circuit

NOTES ON TESTING AND SPECIFICATIONS

- Note 1 – C_C and C_T are measured using a capacitance bridge (Boonton Electronics Model 75A or equivalent).
- Note 2 – Noise figure measured with diode under test in tuned diode mount using UHF noise source and local oscillator (LO) frequency of 1.0 GHz. The LO power is adjusted for 1.0 mW. IF amplifier NF = 1.5 dB, $f = 30$ MHz, see Figure 5.
- Note 3 – L_S is measured on a package having a short instead of a die, using an impedance bridge (Boonton Radio Model 250A RX Meter).

**TYPICAL CHARACTERISTICS
MBD330DWT1**

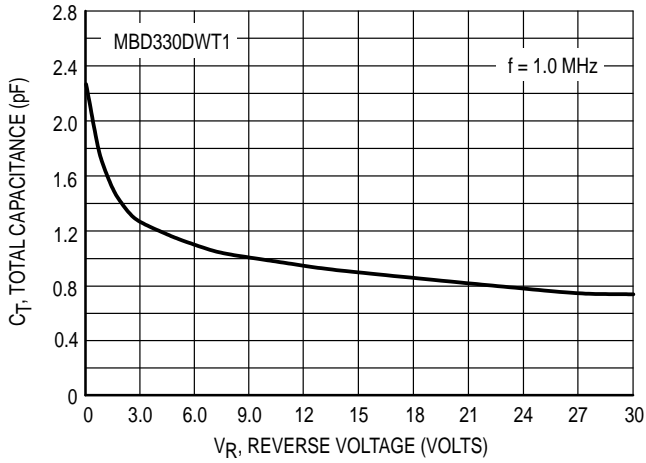

Figure 6. Total Capacitance

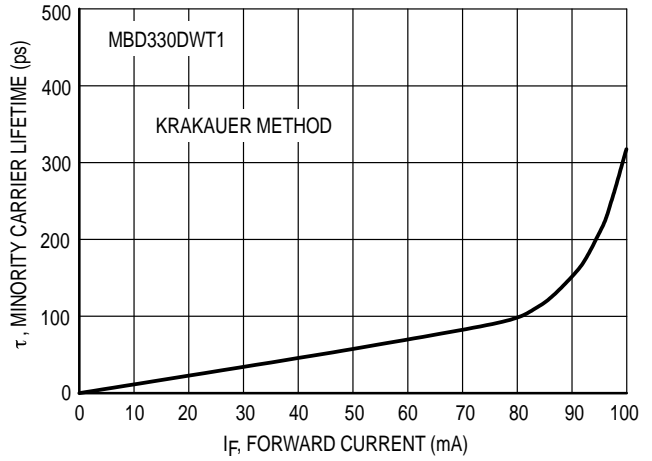

Figure 7. Minority Carrier Lifetime

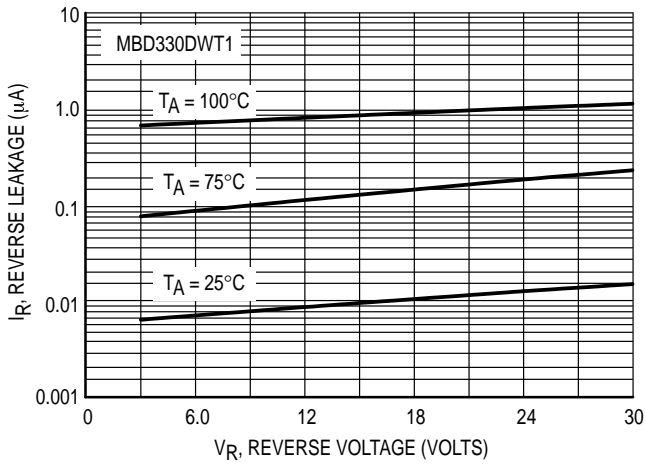

Figure 8. Reverse Leakage

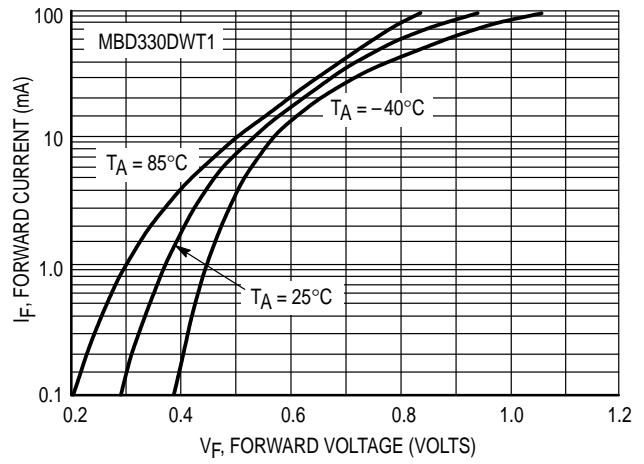

Figure 9. Forward Voltage

TYPICAL CHARACTERISTICS
MBD770DWT1

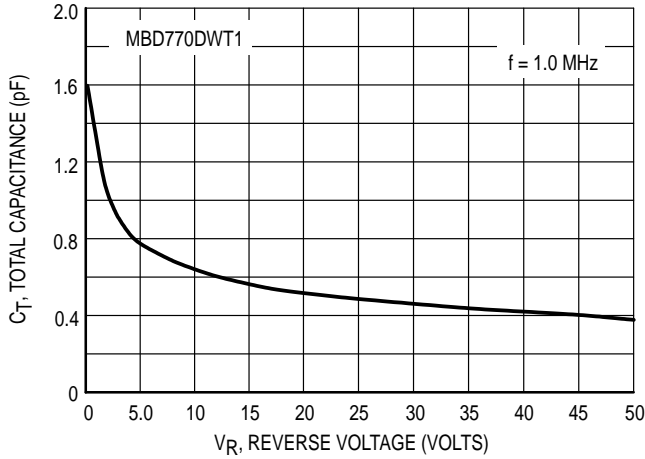

Figure 10. Total Capacitance

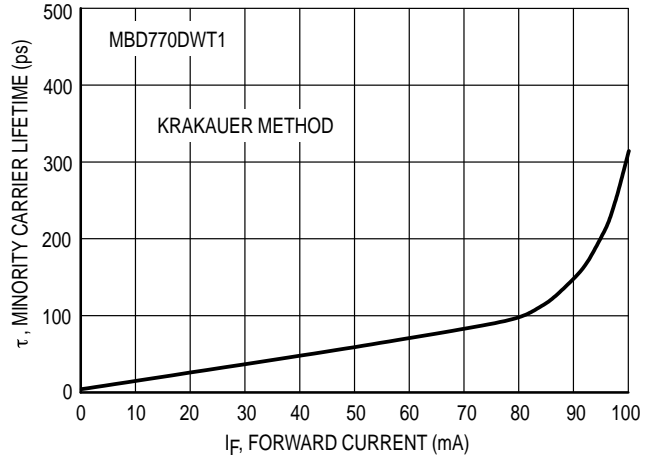

Figure 11. Minority Carrier Lifetime

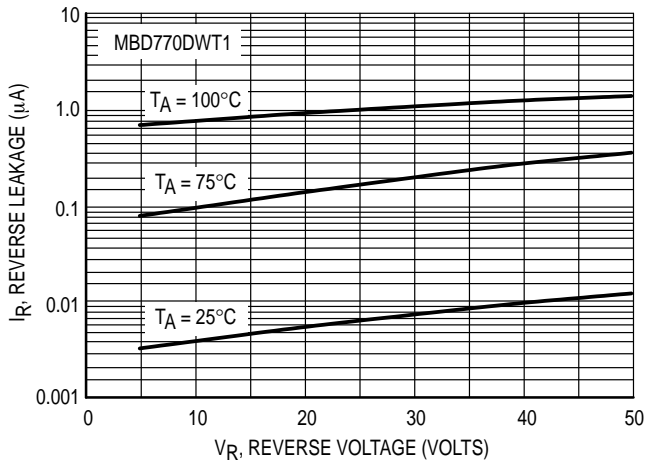

Figure 12. Reverse Leakage

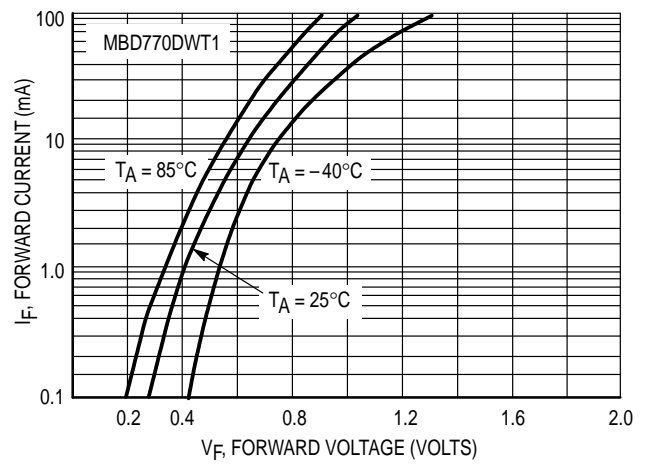

Figure 13. Forward Voltage

INFORMATION FOR USING THE SOT-363 SURFACE MOUNT PACKAGE

MINIMUM RECOMMENDED FOOTPRINT FOR SURFACE MOUNTED APPLICATIONS

Surface mount board layout is a critical portion of the total design. The footprint for the semiconductor packages must be the correct size to insure proper solder connection

interface between the board and the package. With the correct pad geometry, the packages will self align when subjected to a solder reflow process.

SOT-363

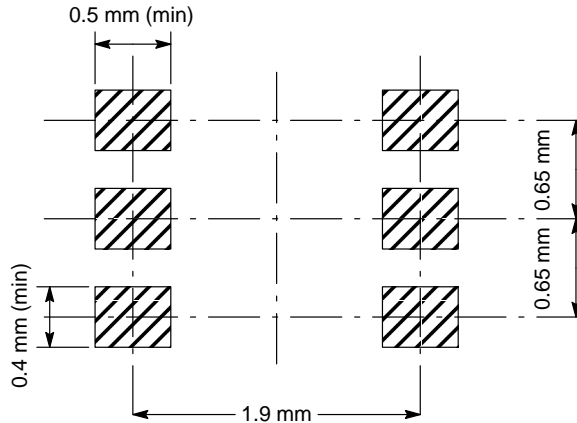

SOT-363 POWER DISSIPATION

The power dissipation of the SOT-363 is a function of the pad size. This can vary from the minimum pad size for soldering to a pad size given for maximum power dissipation. Power dissipation for a surface mount device is determined by $T_{J(max)}$, the maximum rated junction temperature of the die, $R_{\theta JA}$, the thermal resistance from the device junction to ambient, and the operating temperature, T_A . Using the values provided on the data sheet for the SOT-363 package, P_D can be calculated as follows:

$$P_D = \frac{T_{J(max)} - T_A}{R_{\theta JA}}$$

The values for the equation are found in the maximum ratings table on the data sheet. Substituting these values into the equation for an ambient temperature T_A of 25°C, one can calculate the power dissipation of the device which in this case is 120 milliwatts.

$$P_D = \frac{125^\circ\text{C} - 25^\circ\text{C}}{833^\circ\text{C/W}} = 120 \text{ milliwatts}$$

The 833°C/W for the SOT-363 package assumes the use of the recommended footprint on a glass epoxy printed circuit board to achieve a power dissipation of 120 milliwatts. There are other alternatives to achieving higher power dissipation from the SOT-363 package. Another alternative would be to use a ceramic substrate or an aluminum core board such as Thermal Clad™. Using a board material such as Thermal Clad, an aluminum core board, the power dissipation can be doubled using the same footprint.

SOLDERING PRECAUTIONS

The melting temperature of solder is higher than the rated temperature of the device. When the entire device is heated to a high temperature, failure to complete soldering within a short time could result in device failure. Therefore, the following items should always be observed in order to minimize the thermal stress to which the devices are subjected.

- Always preheat the device.
- The delta temperature between the preheat and soldering should be 100°C or less.*
- When preheating and soldering, the temperature of the leads and the case must not exceed the maximum temperature ratings as shown on the data sheet. When using infrared heating with the reflow soldering method, the difference shall be a maximum of 10°C.
- The soldering temperature and time shall not exceed 260°C for more than 10 seconds.
- When shifting from preheating to soldering, the maximum temperature gradient shall be 5°C or less.
- After soldering has been completed, the device should be allowed to cool naturally for at least three minutes. Gradual cooling should be used as the use of forced cooling will increase the temperature gradient and result in latent failure due to mechanical stress.
- Mechanical stress or shock should not be applied during cooling.

* Soldering a device without preheating can cause excessive thermal shock and stress which can result in damage to the device.

PACKAGE DIMENSIONS

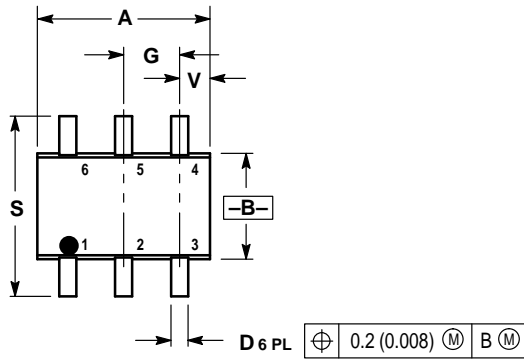

- NOTES:
 1. DIMENSIONING AND TOLERANCING PER ANSI Y14.5M, 1982.
 2. CONTROLLING DIMENSION: INCH.

DIM	INCHES		MILLIMETERS	
	MIN	MAX	MIN	MAX
A	0.071	0.087	1.80	2.20
B	0.045	0.053	1.15	1.35
C	0.031	0.043	0.80	1.10
D	0.004	0.012	0.10	0.30
G	0.026 BSC		0.65 BSC	
H	—	0.004	—	0.10
J	0.004	0.010	0.10	0.25
K	0.004	0.012	0.10	0.30
N	0.008 REF		0.20 REF	
S	0.079	0.087	2.00	2.20
V	0.012	0.016	0.30	0.40

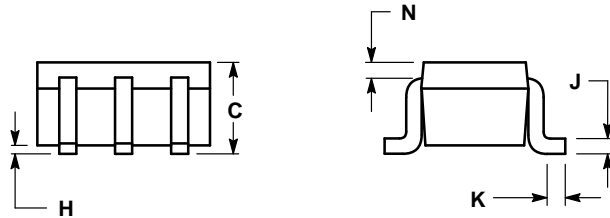

- STYLE 6:
 PIN 1. ANODE 2
 2. N/C
 3. CATHODE 1
 4. ANODE 1
 5. N/C
 6. CATHODE 2

**CASE 419B-01
 ISSUE C**

Motorola reserves the right to make changes without further notice to any products herein. Motorola makes no warranty, representation or guarantee regarding the suitability of its products for any particular purpose, nor does Motorola assume any liability arising out of the application or use of any product or circuit, and specifically disclaims any and all liability, including without limitation consequential or incidental damages. "Typical" parameters which may be provided in Motorola data sheets and/or specifications can and do vary in different applications and actual performance may vary over time. All operating parameters, including "Typicals" must be validated for each customer application by customer's technical experts. Motorola does not convey any license under its patent rights nor the rights of others. Motorola products are not designed, intended, or authorized for use as components in systems intended for surgical implant into the body, or other applications intended to support or sustain life, or for any other application in which the failure of the Motorola product could create a situation where personal injury or death may occur. Should Buyer purchase or use Motorola products for any such unintended or unauthorized application, Buyer shall indemnify and hold Motorola and its officers, employees, subsidiaries, affiliates, and distributors harmless against all claims, costs, damages, and expenses, and reasonable attorney fees arising out of, directly or indirectly, any claim of personal injury or death associated with such unintended or unauthorized use, even if such claim alleges that Motorola was negligent regarding the design or manufacture of the part. Motorola and  are registered trademarks of Motorola, Inc. Motorola, Inc. is an Equal Opportunity/Affirmative Action Employer.

Mfax is a trademark of Motorola, Inc.

How to reach us:

USA/EUROPE/Locations Not Listed: Motorola Literature Distribution;
P.O. Box 5405, Denver, Colorado 80217. 1-303-675-2140 or 1-800-441-2447

JAPAN: Motorola Japan Ltd.; SPD, Strategic Planning Office, 141,
4-32-1 Nishi-Gotanda, Shinagawa-ku, Tokyo, Japan. 81-3-5487-8488

Customer Focus Center: 1-800-521-6274

Mfax™: RMFAX0@email.sps.mot.com – TOUCHTONE 1-602-244-6609
Motorola Fax Back System – US & Canada ONLY 1-800-774-1848
– <http://sps.motorola.com/mfax/>

ASIA/PACIFIC: Motorola Semiconductors H.K. Ltd.; Silicon Harbour Centre,
2, Dai King Street, Tai Po Industrial Estate, Tai Po, N.T., Hong Kong.
852-26668334

HOME PAGE: <http://motorola.com/sps/>

