

Major Ratings and Characteristics

Characteristics	40L45CW	Units
$I_{F(AV)}$ Rectangular waveform	40	A
V_{RRM}	45	V
I_{FSM} @ tp = 5 μ s sine	1240	A
V_F @ 20 Apk, $T_J = 125^\circ\text{C}$ (per leg, Typical)	0.42	V
T_J	-55 to 150	$^\circ\text{C}$

Description/Features

The 40L45CW center tap Schottky rectifier has been optimized for very low forward voltage drop, with moderate leakage. The proprietary barrier technology allows for reliable operation up to 150 $^\circ\text{C}$ junction temperature. Typical applications are in switching power supplies.

- 150 $^\circ\text{C}$ T_J operation
- Center tap TO-247 package
- High purity, high temperature epoxy encapsulation for enhanced mechanical strength and moisture resistance
- Very low forward voltage drop
- High frequency operation
- Guard ring for enhanced ruggedness and long term reliability

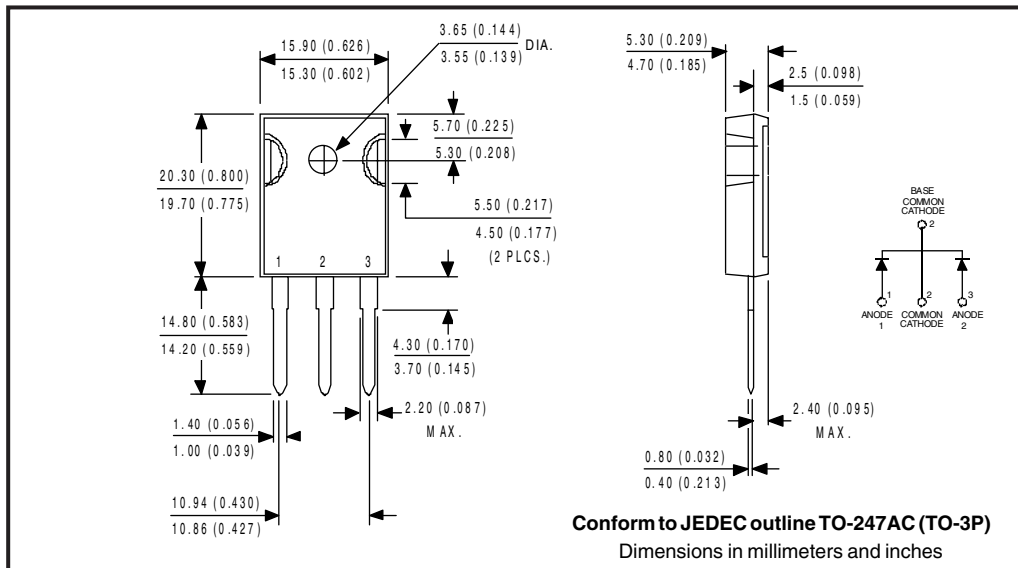

Voltage Ratings

Part number	40L45CW
V_R Max. DC Reverse Voltage (V)	45
V_{RWM} Max. Working Peak Reverse Voltage (V)	

Absolute Maximum Ratings

Parameters	40L45CW	Units	Conditions
$I_{F(AV)}$ Max. Average Forward Current (Per Leg) * See Fig. 5 (Per Device)	20 40	A	50% duty cycle @ $T_C = 122^\circ\text{C}$, rectangular wave form
I_{FSM} Max. Peak One Cycle Non-Repetitive Surge Current (Per Leg) * See Fig. 7	1240 350	A	5 μs Sine or 3 μs Rect. pulse 10ms Sine or 6ms Rect. pulse Following any rated load condition and with rated V_{RWM} applied
E_{AS} Non-Repetitive Avalanche Energy (Per Leg)	20	mJ	$T_J = 25^\circ\text{C}$, $I_{AS} = 3$ Amps, $L = 4.4$ mH
I_{AR} Repetitive Avalanche Current (Per Leg)	3	A	Current decaying linearly to zero in 1 μsec Frequency limited by T_J max. $V_A = 1.5 \times V_R$ typical

Electrical Specifications

Parameters	40L45CW	Units	Conditions
V_{FM} Forward Voltage Drop (Per Leg) * See Fig. 1 (1)	Typ. Max.		
	0.48 0.53	V	@ 20A $T_J = 25^\circ\text{C}$
	0.61 0.69	V	@ 40A
	0.42 0.49	V	@ 20A $T_J = 125^\circ\text{C}$
	0.60 0.70	V	@ 40A
I_{RM} Reverse Leakage Current (Per Leg) * See Fig. 2 (1)	- 1.5	mA	$T_J = 25^\circ\text{C}$ $V_R = \text{rated } V_R$
	20 80	mA	$T_J = 100^\circ\text{C}$
$V_{F(TO)}$ Threshold Voltage	0.27	V	$T_J = T_J$ max.
r_t Forward Slope Resistance	8.72	m Ω	
C_T Max. Junction Capacitance (Per Leg)	- 1500	pF	$V_R = 5V_{DC}$, (test signal range 100Khz to 1Mhz) 25°C
L_S Typical Series Inductance (Per Leg)	7.5 -	nH	Measured lead to lead 5mm from package body
dv/dt Max. Voltage Rate of Change (Rated V_R)	10,000	V/ μs	

(1) Pulse Width < 300 μs , Duty Cycle < 2%

Thermal-Mechanical Specifications

Parameters	40L45CW	Units	Conditions
T_J Max. Junction Temperature Range	-55 to 150	$^\circ\text{C}$	
T_{stg} Max. Storage Temperature Range	-55 to 150	$^\circ\text{C}$	
R_{thJC} Max. Thermal Resistance Junction to Case (Per Leg)	1.6	$^\circ\text{C}/\text{W}$	DC operation * See Fig. 4
R_{thJC} Max. Thermal Resistance Junction to Case (Per Package)	0.8	$^\circ\text{C}/\text{W}$	DC operation
R_{thCS} Typical Thermal Resistance, Case to Heatsink	0.24	$^\circ\text{C}/\text{W}$	Mounting surface, smooth and greased
wt Approximate Weight	6(0.21)	g(oz.)	
T Mounting Torque	Min. 6(5) Max. 12(10)	Kg-cm (lbf-in)	Non-lubricated threads
Case Style	TO-247AC(TO-3P)	JEDEC	

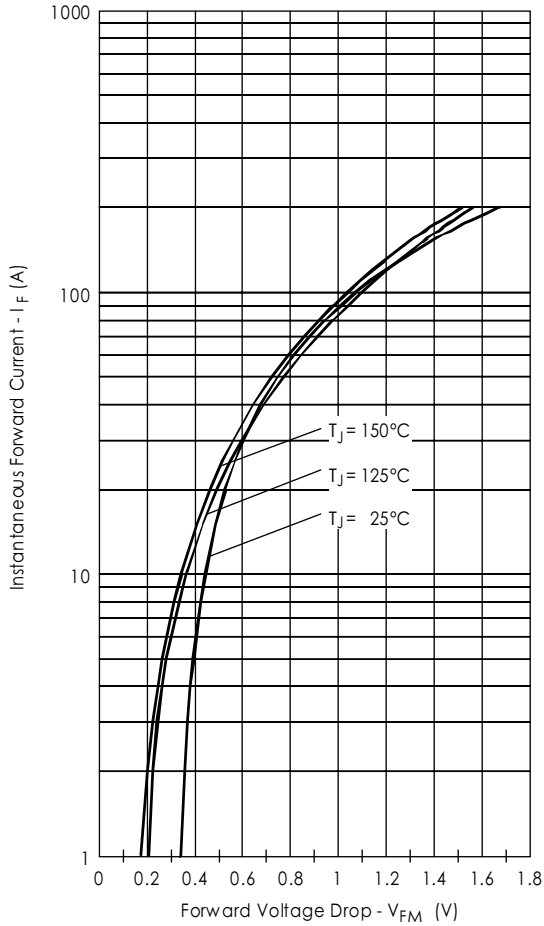

Fig. 1 - Max. Forward Voltage Drop Characteristics (PerLeg)

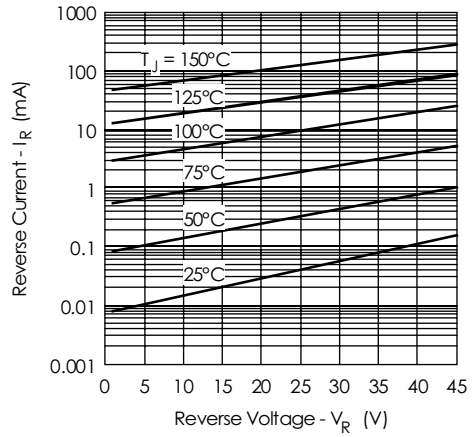

Fig. 2 - Typical Values Of Reverse Current Vs. Reverse Voltage (Per Leg)

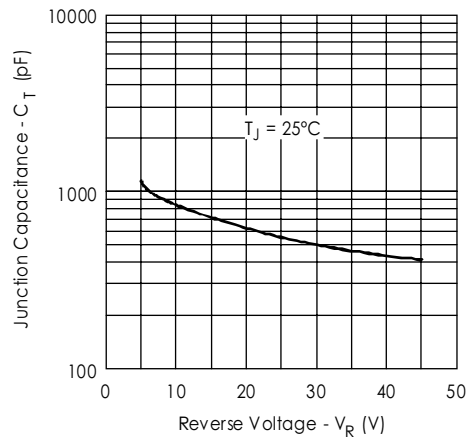

Fig. 3 - Typical Junction Capacitance Vs. Reverse Voltage (Per Leg)

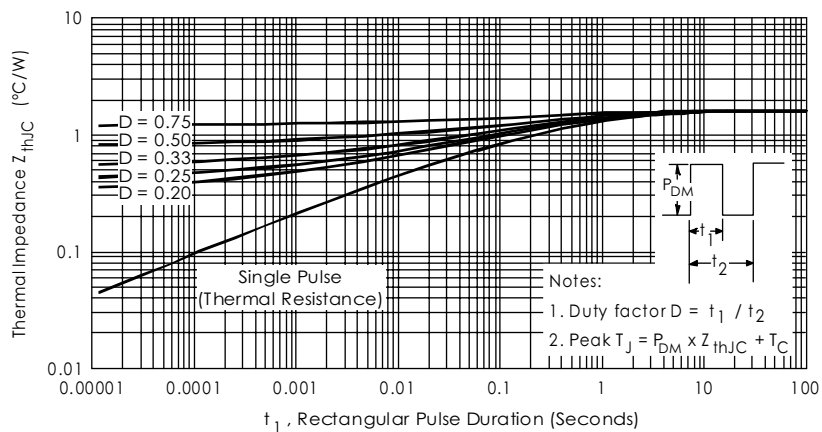

Fig. 4 - Max. Thermal Impedance Z_{thJC} Characteristics (Per Leg)

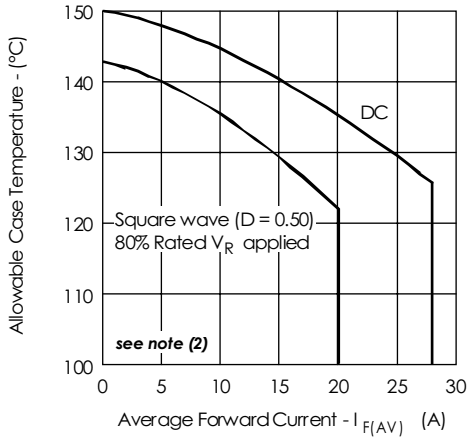

Fig. 5- Max. Allowable Case Temperature Vs. Average Forward Current (Per Leg)

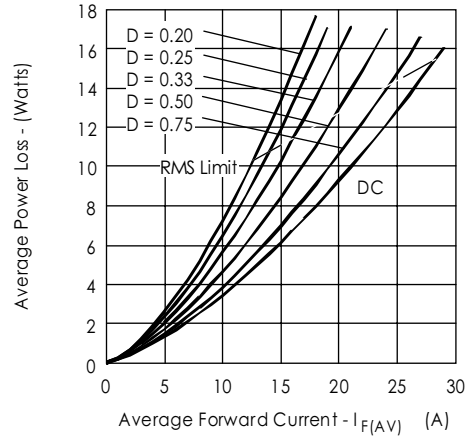

Fig. 6- Forward Power Loss Characteristics (Per Leg)

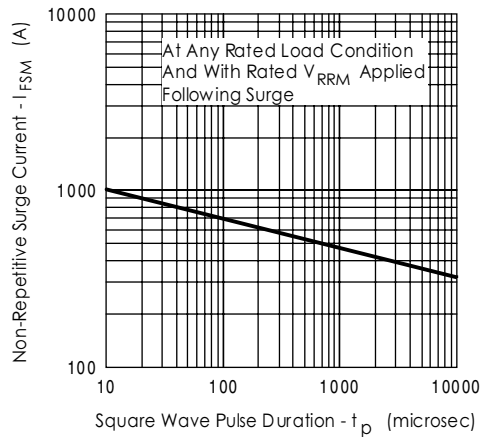

Fig. 7- Max. Non-Repetitive Surge Current (Per Leg)

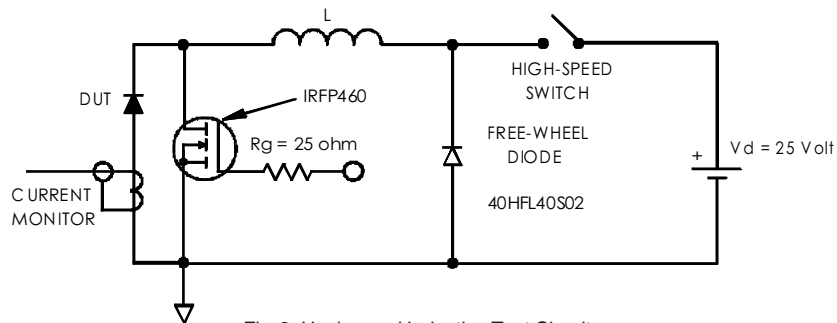

Fig. 8- Unclamped Inductive Test Circuit

(2) Formula used: $T_c = T_j - (P_d + P_{d_{REV}}) \times R_{thJC}$;

P_d = Forward Power Loss = $I_{F(AV)} \times V_{FM} @ (I_{F(AV)} / D)$ (see Fig. 6);

$P_{d_{REV}}$ = Inverse Power Loss = $V_{R1} \times I_{R1} (1 - D)$; $I_{R1} @ V_{R1} = 80\%$ rated V_R

International
IOR Rectifier

WORLD HEADQUARTERS: 233 Kansas St., El Segundo, California 90245 U.S.A. Tel: (310) 322 3331. Fax: (310) 322 3332.
EUROPEAN HEADQUARTERS: Hurst Green, Oxted, Surrey RH8 9BB, U.K. Tel: ++ 44 1883 732020. Fax: ++ 44 1883 733408.
IR CANADA: 15 Lincoln Court, Brampton, Markham, Ontario L6T3Z2. Tel: (905) 453 2200. Fax: (905) 475 8801.
IR GERMANY: Saalburgstrasse 157, 61350 Bad Homburg. Tel: ++ 49 6172 96590. Fax: ++ 49 6172 965933.
IR ITALY: Via Liguria 49, 10071 Borgaro, Torino. Tel: ++ 39 11 4510111. Fax: ++ 39 11 4510220.
IR FAR EAST: K&H Bldg., 2F, 30-4 Nishi-Ikebukuro 3-Chome, Toshima-Ku, Tokyo, Japan 171. Tel: 81 3 3983 0086.
IR SOUTHEAST ASIA: 1 Kim Seng Promenade, Great World City West Tower, 13-11, Singapore 237994. Tel: ++ 65 838 4630.
IR TAIWAN: 16 Fl. Suite D.207, Sec. 2, Tun Haw South Road, Taipei, 10673, Taiwan. Tel: 886 2 2377 9936.