

TA4003F

VHF~UHF WIDE BAND AMPLIFIER

FEATURES

- Band Width 1.5 CHz (Typ.) (3 dB down, $V_{CC} = 2V$)
- High Gain : $|S_{21}|^2 = 11\text{dB}$ (Typ.), ($f = 500\text{MHz}$, $V_{CC} = 2V$)
- Operating Supply Voltage : $V_{CC} = 2\sim 3V$
- Low Current Operation : $I_{CC} = 3.5\text{mA}$ (Typ.) ($V_{CC} = 2V$)
- Small Package

PIN ASSIGNMENT (TOP VIEW)

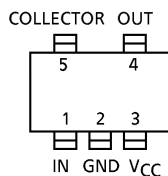

MARKING

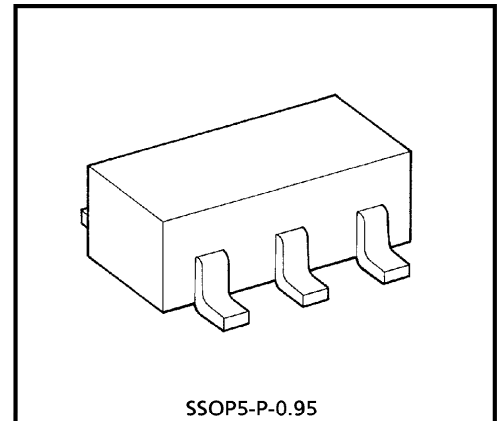
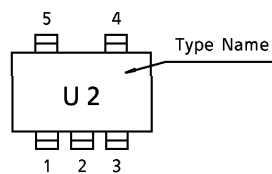

Weight : 0.014 g (Typ.)

MAXIMUM RATINGS ($T_a = 25^\circ\text{C}$)

CHARACTERISTIC	SYMBOL	RATING	UNIT
Supply Voltage	V_{CC}	4	V
Total Power Dissipation	P_D (*)	300	mW
Operating Temperature	T_{opr}	- 40~85	$^\circ\text{C}$
Storage Temperature	T_{stg}	- 55~125	$^\circ\text{C}$

(*) : When mounted glass epoxy of $2.5\text{cm}^2 \times 1.6\text{t}$

980910EBA1

- TOSHIBA is continually working to improve the quality and the reliability of its products. Nevertheless, semiconductor devices in general can malfunction or fail due to their inherent electrical sensitivity and vulnerability to physical stress. It is the responsibility of the buyer, when utilizing TOSHIBA products, to observe standards of safety, and to avoid situations in which a malfunction or failure of a TOSHIBA product could cause loss of human life, bodily injury or damage to property. In developing your designs, please ensure that TOSHIBA products are used within specified operating ranges as set forth in the most recent products specifications. Also, please keep in mind the precautions and conditions set forth in the TOSHIBA Semiconductor Reliability Handbook.
- The products described in this document are subject to the foreign exchange and foreign trade laws.
- The information contained herein is presented only as a guide for the applications of our products. No responsibility is assumed by TOSHIBA CORPORATION for any infringements of intellectual property or other rights of the third parties which may result from its use. No license is granted by implication or otherwise under any intellectual property or other rights of TOSHIBA CORPORATION or others.
- The information contained herein is subject to change without notice.

ELECTRICAL CHARACTERISTICS (Ta = 25°C) (Note 1)

CHARACTERISTIC	SYMBOL	TEST CIRCUIT	TEST CONDITION	MIN.	TYP.	MAX.	UNIT
Circuit Current	I _{CC}	—	V _{CC} = 2 V, Non carrier	2.5	3.5	4.5	mA
Insertion Gain	S ₂₁ ²	1	V _{CC} = 2 V, f = 500 MHz	9	11	14	dB
Band Width	BW	1	V _{CC} = 2 V (Note 2)	1.2	1.5	—	GHz
Noise Figure	NF	1	V _{CC} = 2 V, f = 500 MHz	—	5.2	7	dB
Input Return Loss	S ₁₁ ²	1	V _{CC} = 2 V, f = 500 MHz	—	-7.5	—	dB
Output Return Loss	S ₂₂ ²	1	V _{CC} = 2 V, f = 500 MHz	—	-7.5	—	dB
Isolation	S ₁₂ ²	1	V _{CC} = 2 V, f = 500 MHz	—	-24	—	dB
Maximum Output Level	P _O	1	V _{CC} = 2 V, f = 500 MHz, Pin = 0 dBmW	—	0	—	dBmW

(Note 1) : Have use for connect inductance between terminal 4 and 5 8 nH at V_{CC} = 2 V

(Note 2) : BW is frequency of 3 dB down from |S₂₁|² at 500 MHz.

TEST CIRCUIT 1 (TOP VIEW)

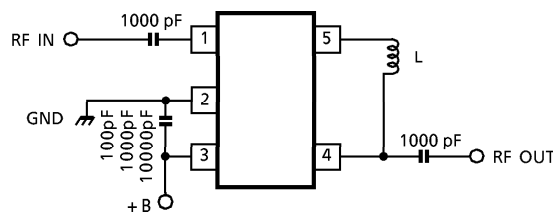

NOTICE

The circuits and measurements contained in this document are given only in the context of as examples of applications for these products. Moreover, these example application circuits are not intended for mass production, since the high-frequency characteristics (the AC characteristics) of these devices will be affected by the external components which the customer uses, by the design of the circuit and by various other conditions. It is the responsibility of the customer to design external circuits which correctly implement the intended application, and to check the characteristics of the design. TOSHIBA assume no responsibility for the integrity of customer circuit designs or applications.

EQUIVALENT CIRCUIT

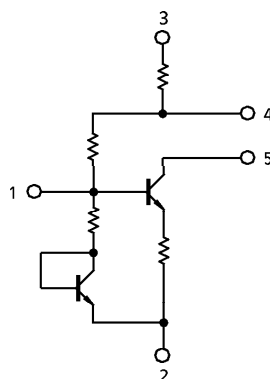

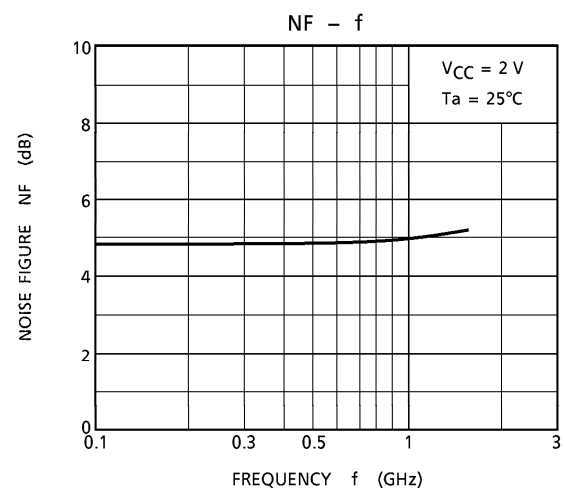
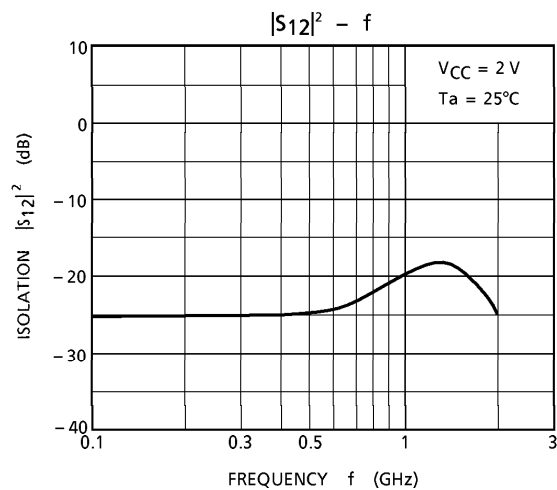
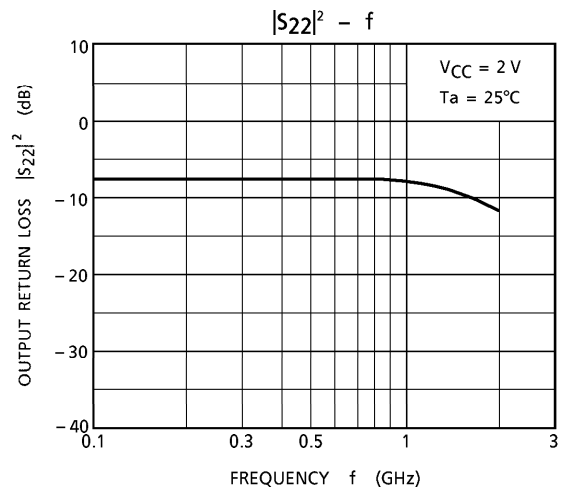
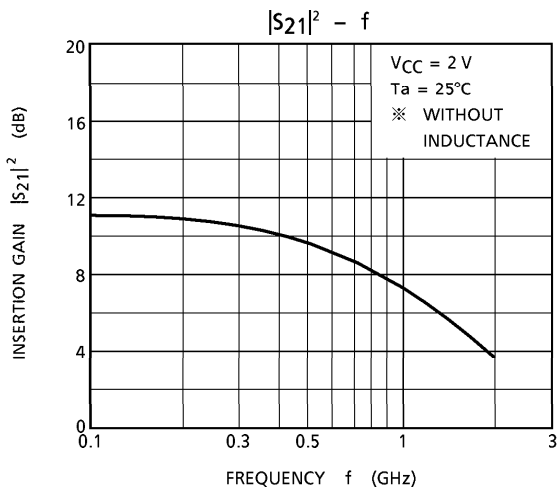
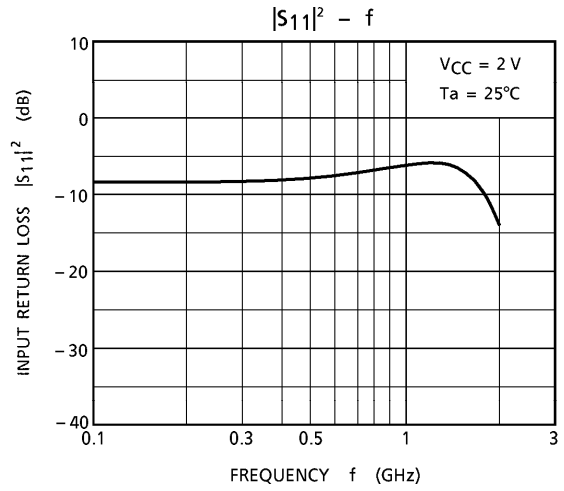
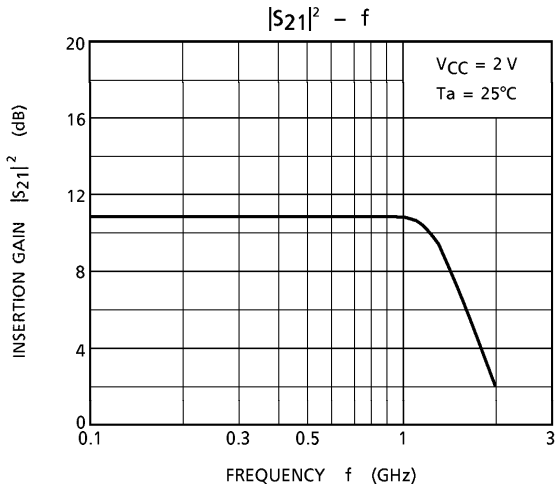

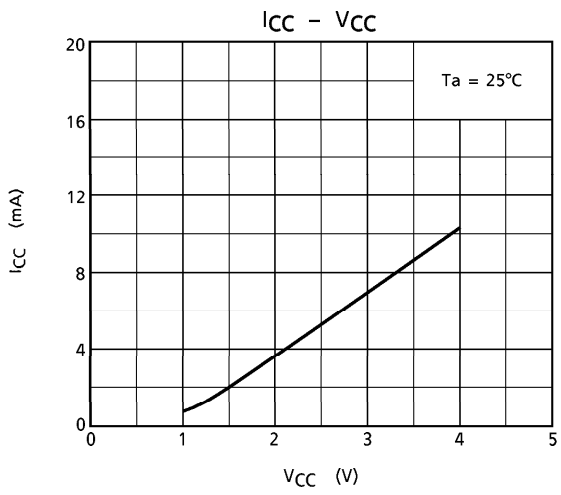
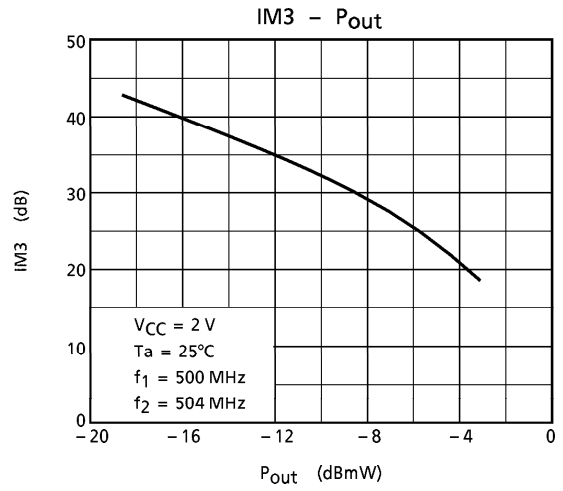
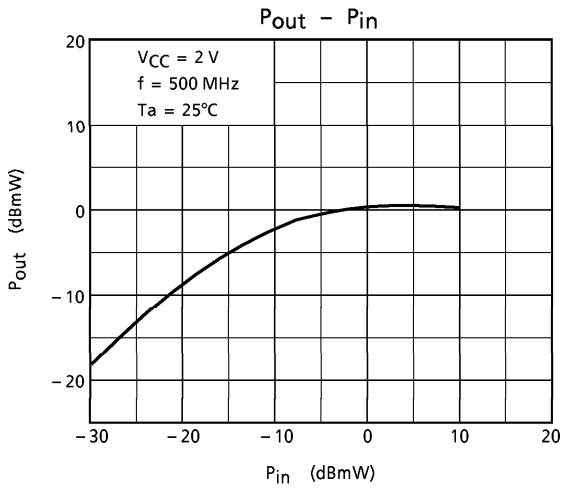

PACKAGE DIMENSIONS
SSOP5-P-0.95

Unit : mm

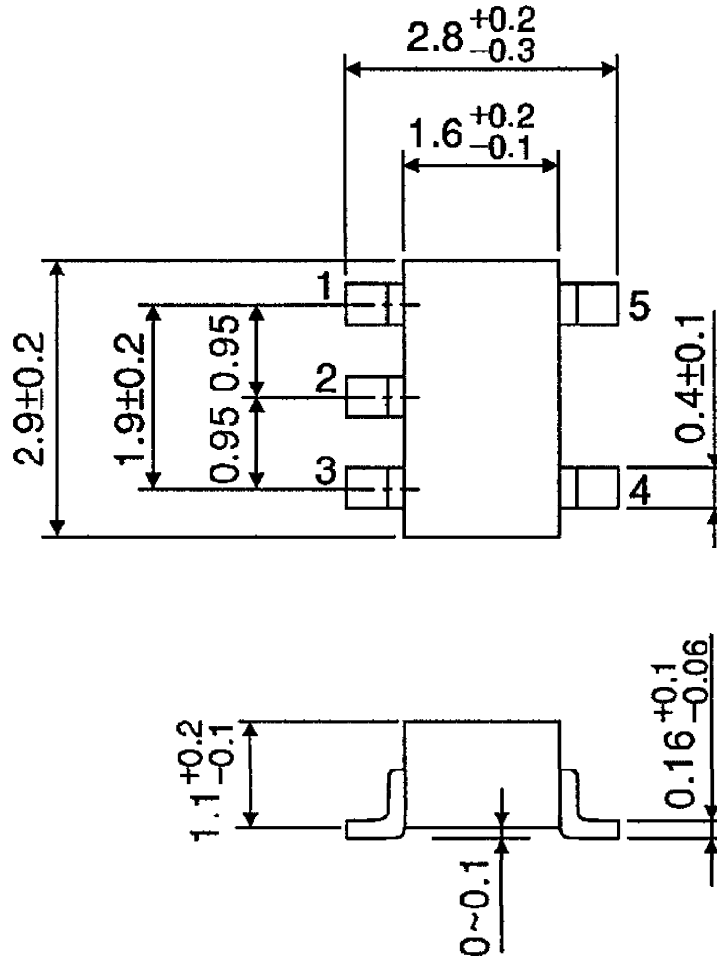

Weight : 0.014 g (Typ.)