

Series PVR33N

Microelectronic Power IC
HEXFET® Power MOSFET Photovoltaic Relay
Dual-Pole, Normally-Open
0-300V AC/DC, 165mA

General Description

The PVR33 Series AC/DC Relay is a dual-pole, normally open, solid-state replacement for electromechanical relays used for general purpose switching of analog signals. It utilizes International Rectifier's HEXFET power MOSFETs as the output switches, driven by an integrated circuit photovoltaic generator of novel construction. The output switch is controlled by radiation from a GaAlAs light emitting diode (LED), which is optically isolated from the photovoltaic generator.

The PVR33 Series overcomes the limitations of both conventional electromechanical and reed relays by offering the solid state advantages of long life, fast operating speed, low pick up power, bounce-free operation, low thermal offset voltages and miniature package. These advantages allow product improvement and design innovations in many applications such as process control, multiplexing, automatic test equipment and data acquisition.

The PVR33 can switch analog signals from thermocouple level to 300 Volts peak AC or DC polarity. Signal frequencies into the RF range are easily controlled and switching rates up to 350Hz are achievable. The extremely small thermally generated offset voltages allow increased measurement accuracies.

These relays are packaged in 16-pin, molded DIP packages and available with through-hole leads, in plastic shipping tubes.

Features

- Bounce-Free Operation
- 10^{10} Off-State Resistance
- 1,000 V/ μ sec dv/dt
- 0.2 μ V Thermal Offset
- 5 mA Input Sensitivity
- 1,500 V_{RMS} I/O Isolation
- Solid-State Reliability

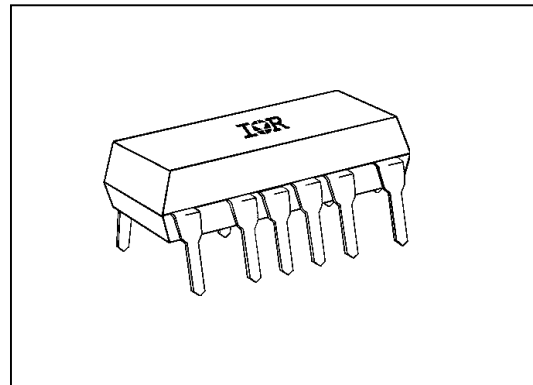

Applications

- Process Control
- Data Acquisition
- Test Equipment
- Multiplexing and Scanning

Part Identification

PVR2300N
PVR3300N
PVR3301N

(HEXFET is the registered trademark for International Rectifier Power MOSFETs)

Series PVR33N

International
IRF Rectifier

Electrical Specifications (-40°C ≤ T_A ≤ +85°C unless otherwise specified)

| INPUT CHARACTERISTICS | | Units |
|--|-------------------|-------------------------------------|
| Minimum Control Current A Connection (see figure 1) For 170 Continuous Load Current For 165 Continuous Load Current For 130 Continuous Load Current | 2.0 5.0 5.0 | DC mA@25°C mA@40°C mA@85°C |
| Minimum Turn-Off Current | 10 | µA(DC) |
| Minimum Turn-Off Voltage | 0.6 | V(DC) |
| Control Current Range (Caution: current limit input LED. See figure 6) | 2.0 to 25 | mA(DC) |
| Maximum Reverse Voltage | 7.0 | V(DC) |

| OUTPUT CHARACTERISTICS | PVR2300N | PVR3300N, PVR3301N | Units |
|--|----------|--------------------|---------------------|
| Operating Voltage Range | ±200 | ±300 | V _(peak) |
| Maximum Load Current 40°C I _{LED} = 5mA (see figure 1) | | | |
| AC (A Connection) | | 165 | mA (peak) |
| DC (B Connection) | | 180 | mA(DC) |
| DC (C Connection) | | 310 | mA(DC) |
| Response Time @25°C (see figures 7 and 8) | | | |
| Maximum T _(on) @ 12mA Control, 100 mA Load, 100 VDC | | 100 | µs |
| Maximum T _(off) @ 12mA Control, 100 mA Load, 100 VDC | | 70 | µs |
| Maximum On-state Resistance 25°C (Pulsed) (fig. 2) 50 mA Load, 5mA Control | | | |
| AC (A Connection) | | 24 | Ω |
| DC (B Connection) | | 12 | Ω |
| DC (C Connection) | | 6 | Ω |
| Minimum Off-state Resistance 25°C @ 160 VDC PVR2300, PVR3300 | | 10 ⁸ | Ω |
| @ 240 VDC PVR3301 | | 10 ¹⁰ | Ω |
| Maximum Thermal Offset Voltage @ 5.0mA Control | | 0.2 | µvolts |
| Minimum Off-State dv/dt | | 1000 | V/µs |
| Typical Output Capacitance (see figure 9) | | 6 | pF @ 50VDC |

| GENERAL CHARACTERISTICS | | Units |
|--|------------------|------------------|
| Dielectric Strength: Input-Output | 1500 | V _{RMS} |
| Insulation Resistance: Input-Output @ 500V _{DC} | 10 ¹² | Ω |
| Maximum Capacitance: Input-Output | 1.0 | pF |
| Maximum Lead Soldering Temperature (1.6mm below seating plane for 10 sec.) | 260 | °C |
| Ambient Temperature Range: | Operating | -40 to +85 |
| | Storage | -40 to +100 |

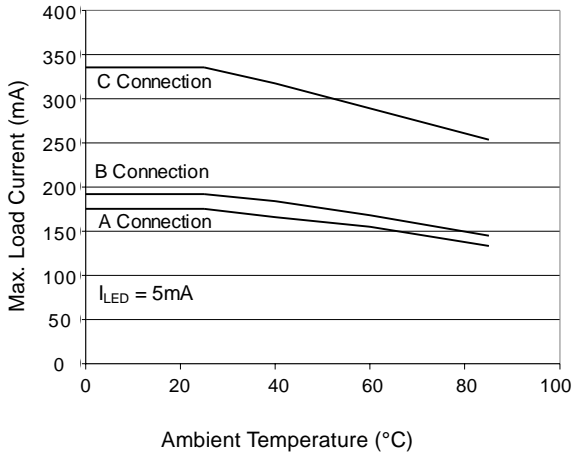

Figure 1. Current Derating Curve

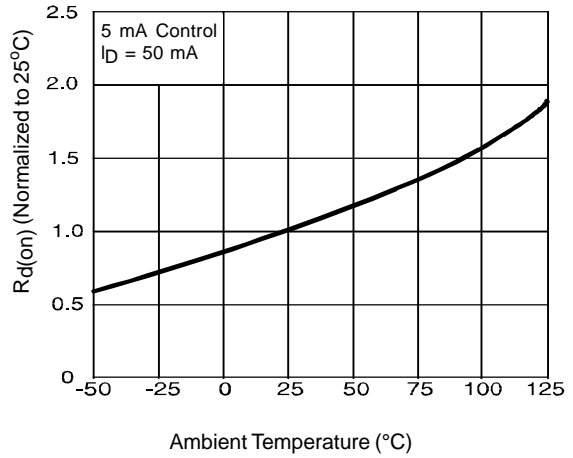

Figure 2. Typical On-Resistance

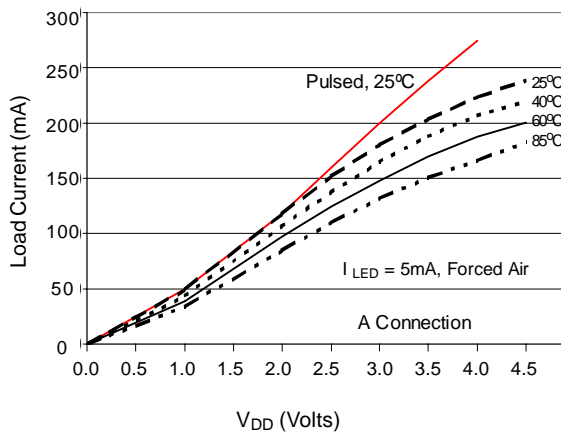

Figure 3. Typical On-Characteristic A Connection

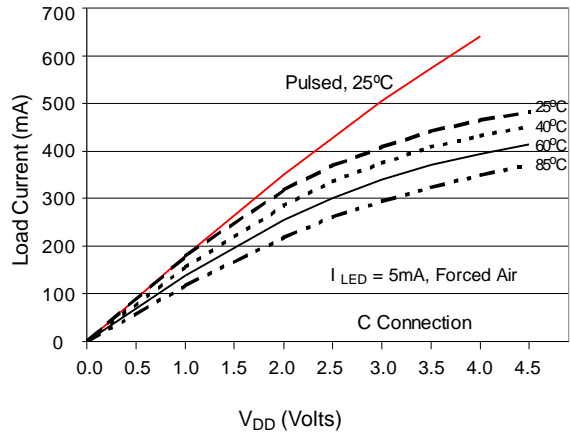

Figure 4. Typical On-Characteristic C Connection

Series PVR33N

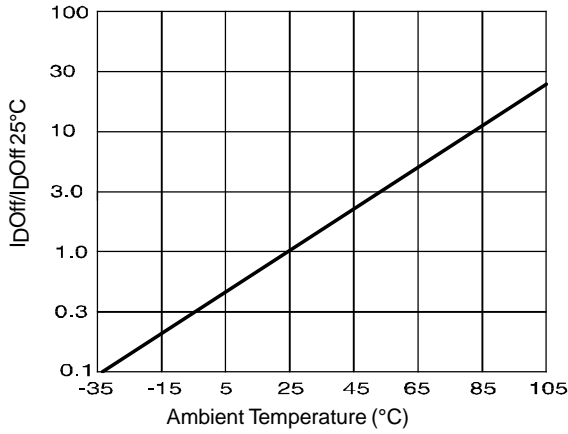

Figure 5. Typical Normalized Off-State Leakage

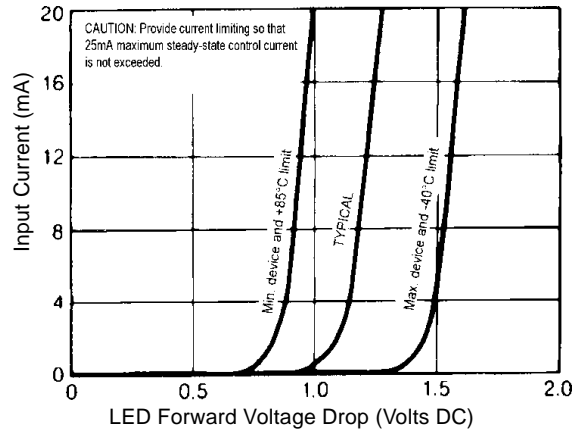

Figure 6. Input Characteristics (Current Controlled)

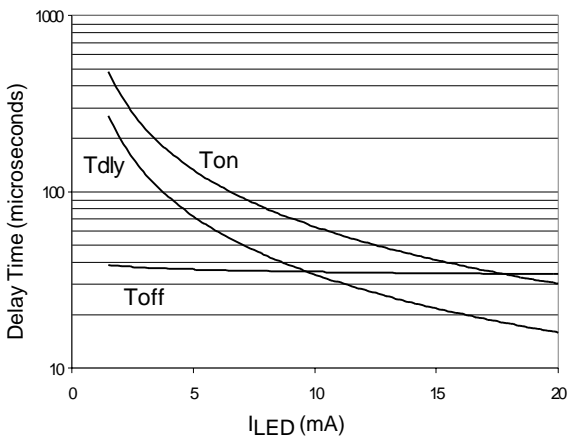

Figure 7. Typical Delay Times

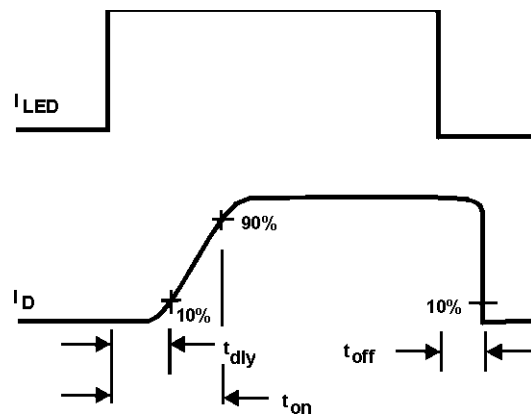

Figure 8. Delay Time Definitions

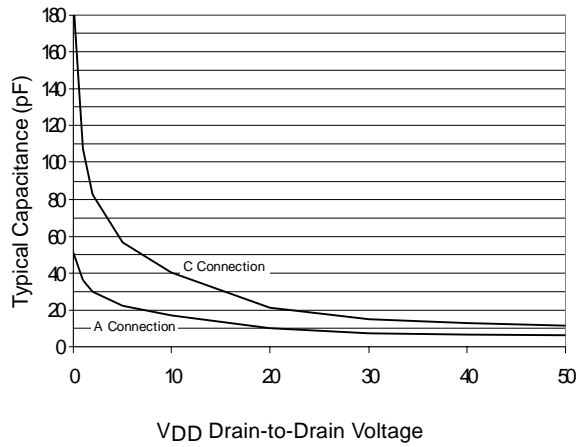
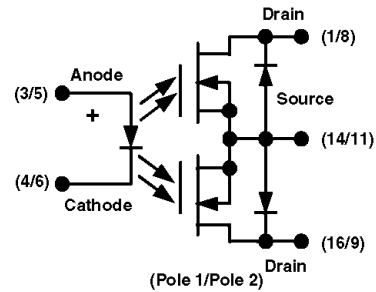
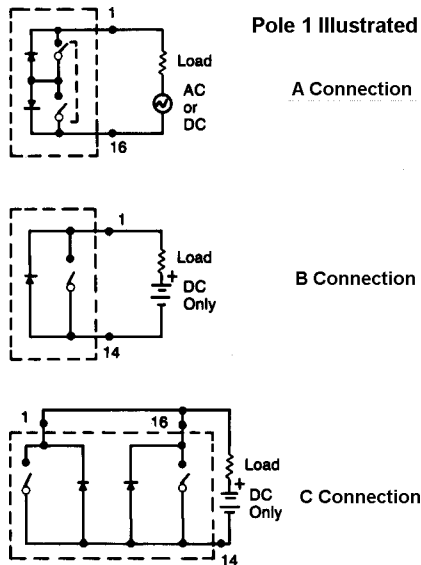

Figure 9. Typical Output Capacitance

Wiring Diagram

Schematic Diagram



Case Outline

