

PLL FOR DTS

DESCRIPTION

The SC9257 is phase-locked loop (PLL) LSIs for digital tuning systems (DTS) with built in 2 modulus prescalers.

All functions are controlled through 3 serial bus lines. These LSIs are used to configure high-performance digital tuning system.

FEATURES

- * Optimal for configuring digital tuning systems in high-fi tuners and car stereos.
- * built-in prescalers. Operate at input frequency ranging from 30~150 MHz during FM_{IN} input (with 2 modulus prescaler) and at 0.5~40MHz during AM_{IN} input (with 2 modulus prescaler or direct dividing).
- * 16 bit programmable counter, dual parallel output phase comparator, crystal oscillator and reference counter.
- * 3.6MHz, 4.5MHz, 7.2MHz or 10.8MHz crystal oscillators can be used.
- * 15 possible reference frequencies. (When using 4.5MHz crystal)
- * Built-in 20 bit general-purpose counter for such uses as measuring intermediate frequencies (IF_{IN1} and IF_{IN2}) and low-frequency pilot signal cycles (SC_{IN}).
- * High-precision ($\pm 0.55 \sim \pm 7.15 \mu s$) PLL phase error detection.
- * Numerous general-purpose I/O pins for such uses as peripheral circuit control.
- * 4 N-channel open-drain output ports (OFF withstanding voltage:12V) for such uses as control signal output.
- * Standby mode function (turns off FM, AM and IF amps) to save current consumption.
- * All functions controlled through 3 serial bus lines.
- * CMOS structure with operating power supply range of V_{DD}=5.0±0.5V.

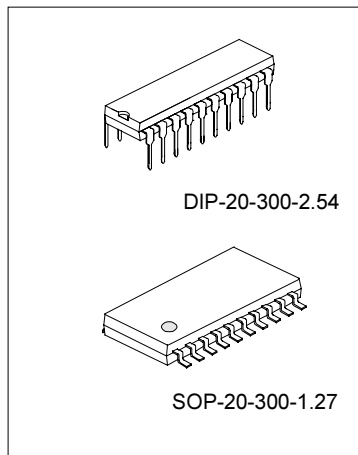

PIN CONFIGURATION

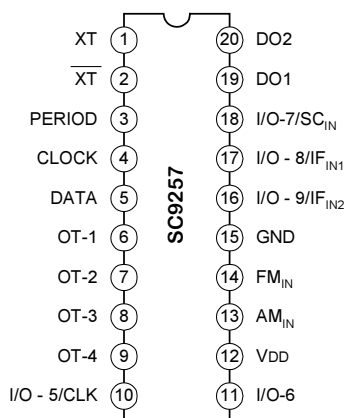

BLOCK DIAGRAM

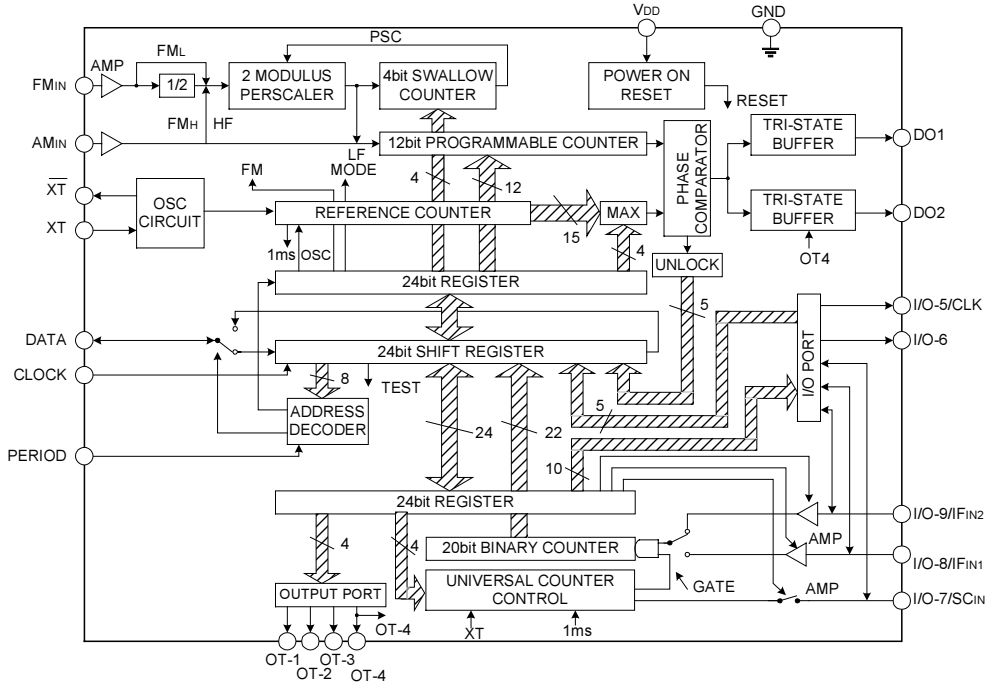

ABSOLUTE MAXIMUM RATINGS (Ta=25°C)

Characteristic	Symbol	Value	Unit
Supply Voltage	VCC	-0.3~6.0	V
Input Voltage	VIN	-0.3~VDD+0.3	V
N-ch Open-Drain Off withstanding Voltage	VOFF	13	V
Power Dissipation	PD	300(200)	mW
Operating Temperature	TOPR	-40~85	°C
Storage Temperature	TSTG	-65~150	°C

ELECTRICAL CHARACTERISTICS (unless otherwise specified, Ta= -40~85°C, VDD=4.5~5.58V.)

Characteristic	Symbol	Test Condition/Pin	Min	Typ.	Max	Unit
Operating Power Supply Voltage	VDD1	PLL operation (normal operating)	4.5	5.0	5.5	V
Operating Power Supply Current	IDD1	VDD=5.0V, XT=10.8MHz, FMIN=150MHz	--	7	15	mA

Stand-by mode

Crystal Oscillation Frequency Supply Voltage	VDD2	PLL OFF (Operating crystal oscillation)	4.0	5.0	5.5	V
Operating Power Supply Current	IDD2	VDD=5.0V, XT =10.8MHz PLL OFF	--	0.8	1.5	mA
Operating Power Supply Current	IDD3	VDD=5.0V, XT stop, PLL OFF	--	120	240	μA

Operating frequency range

Crystal Oscillation Frequency	fXT	Connect crystal resonator to XT- XT terminal	3.6	~	10.8	MHz
FMIN (FMH, FML)	fFM	FMH, FML mode, VIN=0.2Vp-p	30	~	130	MHz
FMIN (FML)	fFML	FML mode, VIN=0.3Vp-p	30	~	150	MHz
AMIN (HF)	fHF	HF mode, VIN=0.2Vp-p	1	~	40	MHz
AMIN (LF)	fLF	LF mode, VIN=0.2Vp-p	0.5	~	20	MHz
IFIN1, IFIN2	fIF	VIN=0.2Vp-p	0.1	~	15	MHz
SCIN	fSC	VIH=0.7VDD, VIL=0.3VDD, square wave input.	--	~	100	kHz

Operating input amplitude range

FMIN (FMH, FML)	VFM	FMH, FML mode, fIN=30~130MHz	0.2	~	VDD-0.5	Vp-p
FMIN (FML)	VFML	FML mode, fIN=30~150MHz	0.3	~	VDD-0.5	Vp-p
AMIN (HF)	VHF	HF mode, fIN=1~40MHz	0.2	~	VDD-0.5	Vp-p
AMIN (LF)	VLf	LF mode, fIN=0.5~20MHz	0.2	~	VDD-0.5	Vp-p
IFIN1, IFIN2	VIF	FIN=0.1~15MHz	0.2	~	VDD-0.5	Vp-p

OT1~OT4 N-ch open drain

Output Current	"L" level	IOL1	VOL=1.0V	5.0	10.0	--	mA
OFF-leak Current		IOEF	VOFF=12V	--	---	2.0	μA

(To be continued)

(Continued)

Characteristic	Symbol	Test Condition/Pin	Min	Typ.	Max	Unit
----------------	--------	--------------------	-----	------	-----	------

I/O-5~I/O-9, SCIN

Input Voltage	"H" level	V _{IH1}		0.7V _{DD}	~	V _{DD}	V
	"L" level	V _{IL1}		0	~	0.3V _{DD}	
Input Current	"H" level	I _{IH}	V _{IH} =5V	--	--	2.0	μA
	"L" level	I _{IL}	V _{IL} =0V	--	--	-2.0	
Output Current	"H" level	I _{OH4}	V _{OH} =4.0V (expect SCIN)	-2.0	-4.0	--	mA
	"L" level	I _{OL4}	V _{OL} =1.0V (expect SCIN)	2.0	4.0	--	

PERIOD, CLOCK, DATA

Input Voltage	"H" level	V _{IH2}		0.8V _{DD}	~	V _{DD}	V
	"L" level	V _{IL2}		0	~	0.2V _{DD}	
Input Current	"H" level	I _{IH}	V _{IH} =5V	--	--	2.0	μA
	"L" level	I _{IL}	V _{IL} =0V	--	--	-2.0	
Output Current	"H" level	I _{OH5}	V _{OH} =4.0V (DATA)	-1.0	-3.0	--	mA
	"L" level	I _{OL5}	V _{OL} =1.0V (DATA)	1.0	3.0	--	

DO1, DO2

Input Current	"H" level	I _{OH3}	V _{OH} =4.0V	-2.0	-4.0	--	mA
	"L" level	I _{OL3}	V _{OL} =1.0V	2.0	4.0	--	
Tri-State Lead Current		I _{TL}	V _{TLH} =5V, V _{TLL} =0V	--	--	±1.0	μA

XT

Output Current	"H" level	I _{OH2}	V _{OH} =4.0V	-0.1	-0.3	--	mA
	"L" level	I _{OL2}	V _{OL} =1.0V	0.1	0.3	--	

Input feedback resistance

Input Feedback Resistance	"H" level	R _{f1}	F _{MIN} , A _{MIN} , I _{FIN} (T _a =25°C)	350	700	1400	kΩ
	"L" level	R _{f2}	X _T - X _T (T _a =25°C)	500	1000	4000	

PIN DESCRIPTION

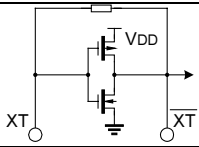
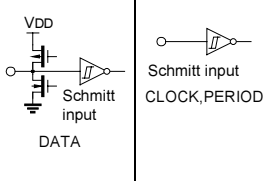
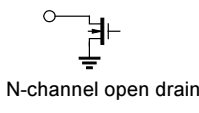
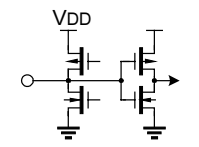
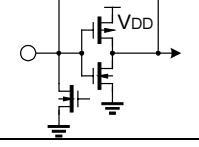
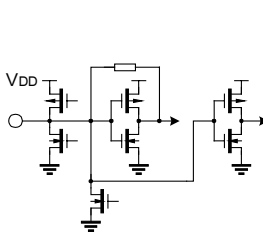
Pin No.	Symbol	Pin name	Description	Circuit diagram
1	XT	Crystal oscillator pins	Connects 3.6MHz, 4.5MHz, 7.2MHz or 10.8MHz crystal oscillator to supply reference frequency and internal clock	
2	$\overline{\text{XT}}$			
3	PERIOD	Period signal input	Serial I/O ports. These pins transfer data to and from the controller to set divisions and dividing modes, and to control the general-purpose counter and general-purpose I/O ports.	
4	CLOCK	Clock signal input		
5	DATA	Serial data input/output		
6	OT-1	General-purpose output ports	N channel open drain port pins, for such uses as control signal output. These pins are set to the OFF state when power is turned on.	
7	OT-2			
8	OT-3			
9	OT-4			
10	I/O-5/CLK	General-purpose I/O ports	CMOS structure allows free use of these ports for input or output. Ports are set for input when the power is turned on , I/O-5 can be switched for use as a system clock output pin.	
11	I/O-6			
13	AMIN	Programmable counter input	These pin input FM and AM band local oscillator signals by capacitor coupling. FMIN and AMIN operate at low amplitude.	
14	FMIN			
16	I/O-9/FIN2	General-purpose I/O ports/General-purpose counter frequency measurement input	General-purpose I/O port input/output pins. Can be switched for use as input pins to measure general-purpose counter frequencies. The frequency measurement function has such uses as measuring intermediate frequencies (IF). These pins feature built-in amps. Data are input by capacitor coupling. FMIN and AMIN operate at low amplitude. (note) Pins are set for input when power is turned on.	
17	I/O-8/FIN1			

(To be continued)

(Continued)

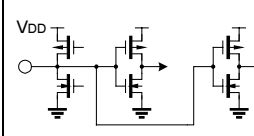
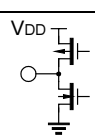
Pin No.	Symbol	Pin name	Description	Circuit diagram
18	I/O-7/SCIN	General-purpose I/O ports/ General-purpose counter cycle measurement input	General-purpose I/O port input/output pin. Can be switched for use as signal input pin to measure low-frequency signal cycles. (note) This pin is set for input when power is turned on.	
19	DO1	Phase comparator output (General-purpose output ports)	These pins are for phase comparator tri-state output. DO1 and DO2 are output in parallel.	
20	DO2/OT-4	Phase comparator output (General-purpose output ports)		
15	GND	Power supply pins	Applies 5.0V±10%	
12	VDD			

FUNCTION DESCRIPTION
Serial I/O ports

As the block diagram shows, the functions are controlled by setting data in the 48 bits contained in each of the 2 sets of 24 bit registers. Each bit of data in these register is transferred through the serial ports between the controller and the DATA, CLOCK and PERIOD pins. Each serial transfer consists of a total of 32 bits, with 8 address bits and 24 data bits.

Since all functions are controlled in units of registers, the explanation in this manual focuses on the 8 bit address and functions of each register.

These registers consist of 24 bits and are selected by an 8 bit address.

A list of the address assignment for each register is given below under register assignments.

Register	Address	Contents of 24 bits	No. of bit
Input register 1	D0H	PLL divisor setting	16
		Reference frequency setting	4
		PLL input and mode setting	2
		Crystal oscillator selection	2
			total 24
Input register 2	D2H	General-purpose counter control (including lock detection bit control)	4
		I/O port and general-purpose counter switching bits	3
		I/O-5/CLK pin switching bit	1
		DO pin control	1
		Test bit	1
		I/O port control (also used as general-purpose counter input selection bits)	5
		Output data	9
	total 24		
Output register 1	D1H	General-purpose counter numeric data	22
		Not used	2
			total 24
Output register 2	D3H	Lock detection data	5
		I/O port control data	5
		Output data	4
		Input data (undefined during output port selection)	5
		Not used	5
			total 24

When the PERIOD signal falls, the input data are latched in register 1 or register 2 and the function is performed.

When the CLOCK signal falls for 9 time, the output data are latched in parallel in the output registers. The data are subsequently output serially from the data pin.

REGISTER ASSIGMENTS

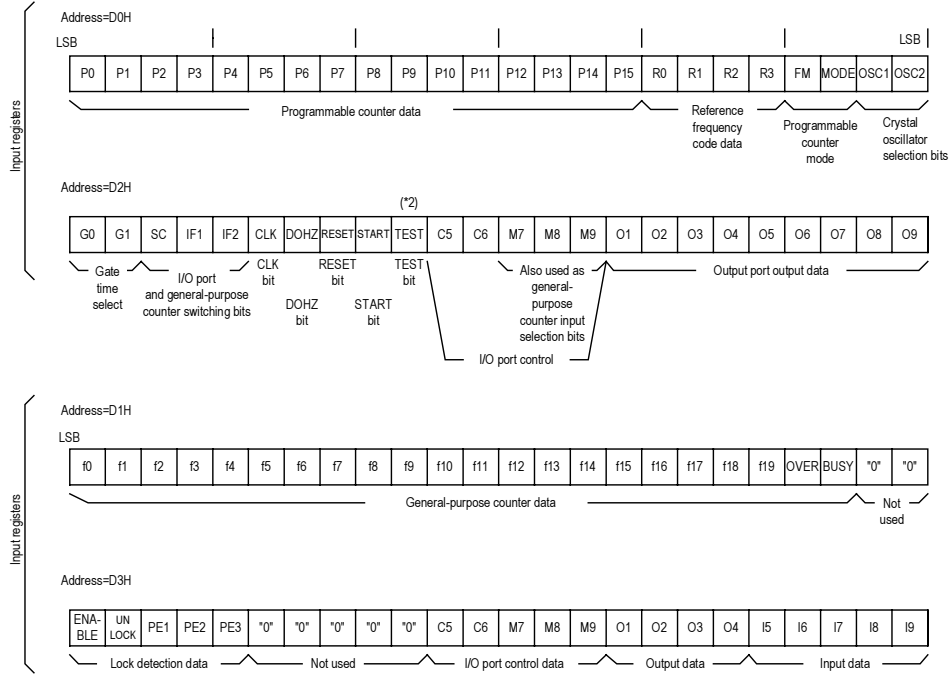

When power is turned on, the input registers are set as shown below.

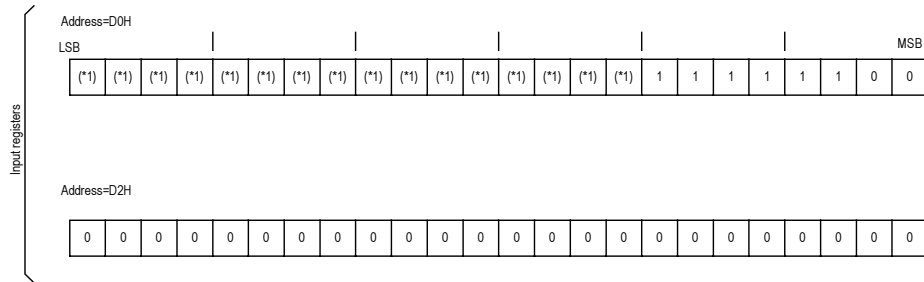

- Note:**
1. Data are undefined.
 2. Set data to "0" for test bit.

Serial transfer format

The serial transfer format consists of 8 address bits and 24 data bits (Fig. 1). Addresses D0H~D3H are used.

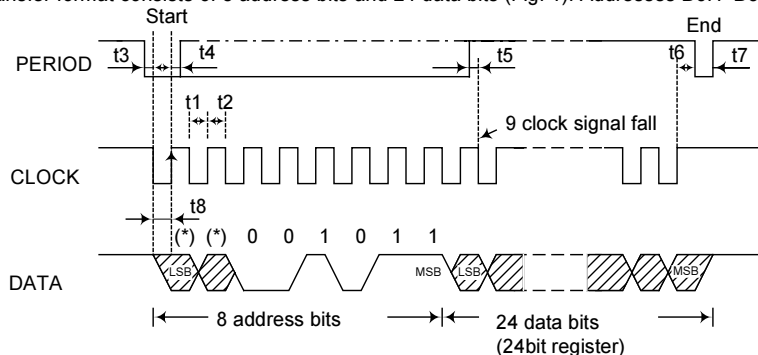

Fig.1

Serial data transfer

serial data are transferred in sync with the clock signal. In the idle state, the PERIOD, CLOCK and DATA pin lines are all set to "H" level. When the period signal is at "L" level, the falling of the clock signal initiates serial data transfer. Data transfer ceases when the period signal is set to "L" level when the clock signal is at "H" level. Once serial data transfer has begun, however, no more than 8 falls of the clock signal can occur during the time the period signal is at "L" level.

Since the receiving side receives the serial data as valid data when the clock signal rises, it is effective for the sending side to produce output in sync with the clock signal fall.

To receive serial data from the output registers (D1H, D3H), set the serial data output to high impedance after the 8 bit address is output but before the next clock signal falls.

Data reception subsequently continues until the period signal becomes "L" level; data transfer ends just before the period signal rises. Therefore, the data pin must have an open-drain or tristate interface.

Note: 1. when power is turned on, some internal circuit have undefined states. To set internal circuit states, execute a dummy data transfer before performing regular data transfer.

2. times t1~t8 have the following value:

$t1 \geq 1.0\mu s$

$t2 \geq 1.0\mu s$

$t3 \geq 0.3\mu s$

$t4 \geq 0.3\mu s$

$t5 \geq 0.3\mu s$

$t6 \geq 1.0\mu s$

$t7 \geq 1.0\mu s$

$t8 \geq 0.3\mu s$

3. Asterisks represent numbers taken from addresses, as in D*H.

Crystal oscillator pins (XT, XT)

As fig.2 shows, the clock necessary for internal operation is produced by connecting a crystal oscillator between capacitors. Use the crystal oscillator selection bit to select an oscillating frequency of 3.6MHz, 4.5MHz, 7.2MHz or 10.8MHz which matches that of the crystal oscillator used.

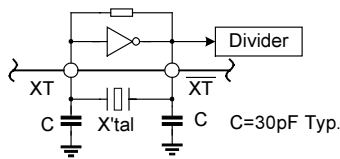
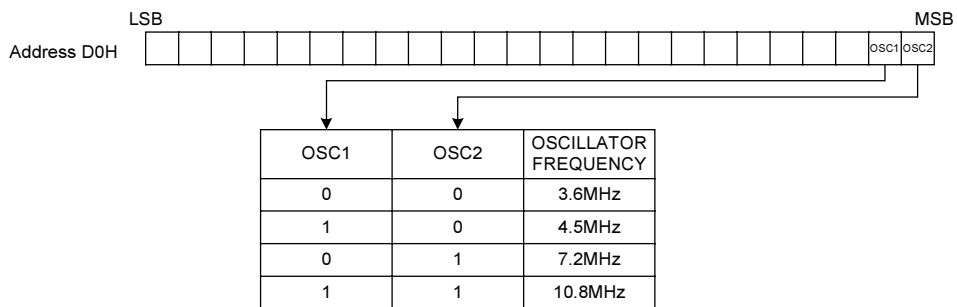

Fig.2

Note: set to 3.6MHz (OSC1="0" and OSC2="0") when power is turned on. The crystal is not oscillating at this time because the system is in standby mode.

Reference counter (Reference frequency divider)

The reference counter section consists of a crystal oscillator and a counter.

A crystal oscillator frequency of 3.6MHZ, 7.2MHZ or 10.8MHZ can be selected .A maximum of 15 reference frequencies can be generated.

1. Setting reference frequency

The reference frequency is set using bits R0~R3.

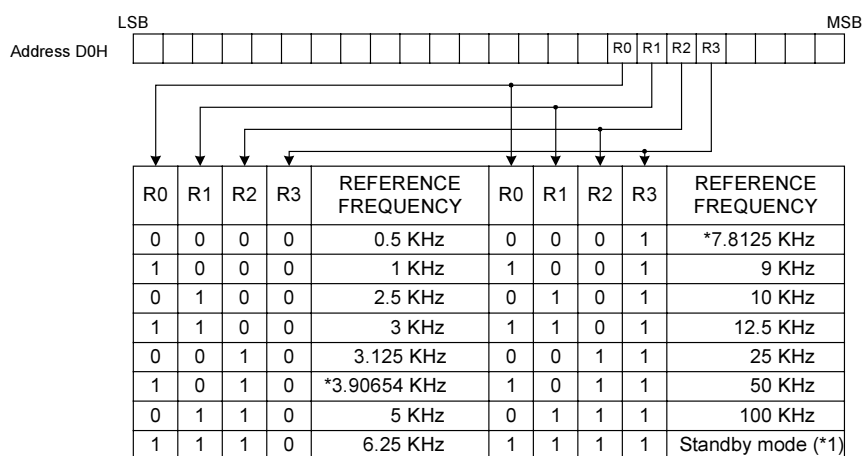

(Note 1) Reference frequencies marked with an asterisk “*” can only be generated with a 4.5MHZ crystal oscillator.

(Note 2) (*1)Standby mode

Standby mode occurs when bits R0,R1,R2,and R3 are all set to “1”.In standby mode, the programmable counter stops, and FM, AM and IFIN(when selected IFIN) are set to “amp off” state (pins at “L” level). This saves current consumption when the radio is turned off. The DO pins become high impedance during standby mode.

During standby mode, the I/O ports (I/O-5~I/O-9) and output ports (OT1~OT4) can be controlled and the crystal oscillator can be turned on and off.

(Note 3) The system is set to standby mode when power is turned on. At this time, the crystal oscillator is not oscillating and the I/O ports are set to input mode.

Programmable counter

The programmable counter section consists of a 1/2 prescaler, a 2 modulus prescaler and a 4bit +12bit programmable binary counter.

1. Setting programmable counter

16 bits of divisor data and 2 bits, which indicate the dividing mode, are set in the programmable counter.

(1) Setting dividing mode

The FM and MODE bits are used to select the input pin and the dividing mode (pulses wallow mode or direct dividing mode). There are 4 possible choices, shown in the table below .Select one based on the frequency band used.

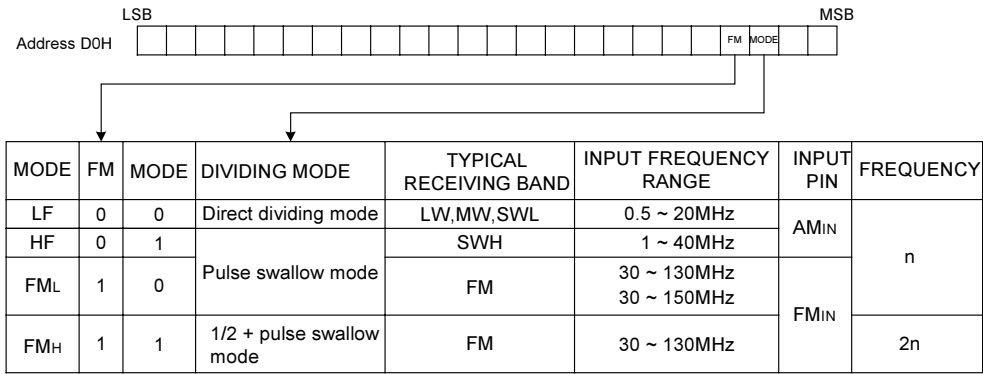

(2) Setting divisor

The divisor for the programmable counter is set as binary data in bits P0~P15.

- Pulse swallow mode (16 bits)

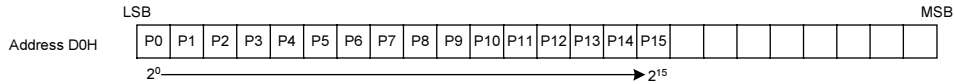

Divisor setting range (pulse swallow mode):n=210H~FFFH (528~65535)

(Note) With the 1/2+pulse swallow mode, the actual divisor is twice the programmed value.

- Direct dividing mode (12 bits)

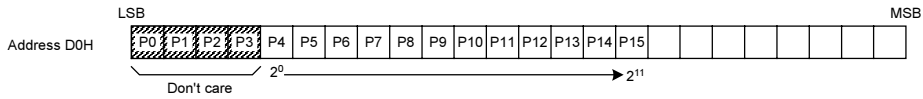

Divisor setting range (direct dividing mode):n=10H~FFFH(16~4095)

With the direct dividing mode, data p0~p3 are don't-care and bit p4 is the LSB.

2. Prescaler and programmable counter circuit configuration

(1) Pulse swallow mode circuit configuration

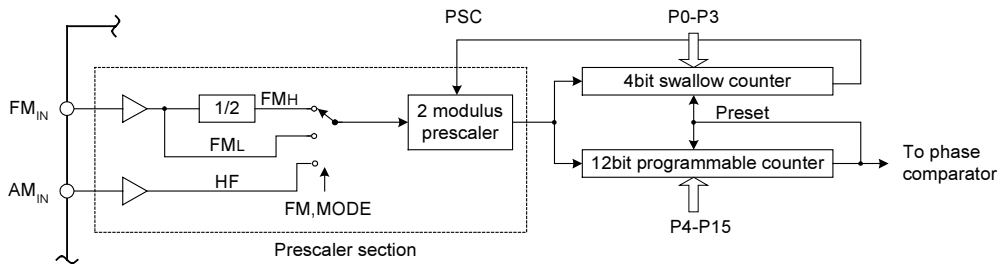

Fig.3

This circuit consists of a 2 modulus prescaler, a 4 bit swallow counter and a 12bit programmable counter. During FM_{IN}(FM_{IN} mode), a 1/2 prescaler is added to the preceding step.

(2) Direct dividing method circuit configuration

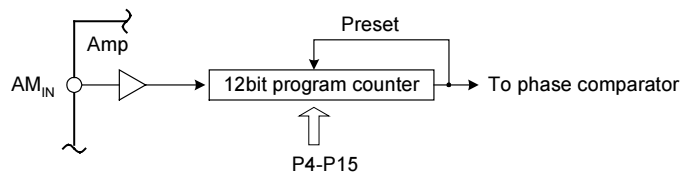

Fig.4

With the direct dividing mode, the prescaler section is bypassed and the 12bit programmable counter is used.

(3) Both FM_{IN} and AM_{IN} have built-in amps. Data are input by capacitor coupling. FM_{IN} and AM_{IN} operate at low amplitude.

General-purpose counter

The general-purpose counter is a 20bit counter. It has such uses as counting AM/FM band intermediate frequencies (IF) and detecting auto-stop signals during auto-search tuning. It also features a cycle measurement function for such uses as measuring low-frequency pilot signal cycles.

1. General-purpose counter control bits

(1) Bits G0 and G1 ... Used for selecting the general-purpose counter gate time.

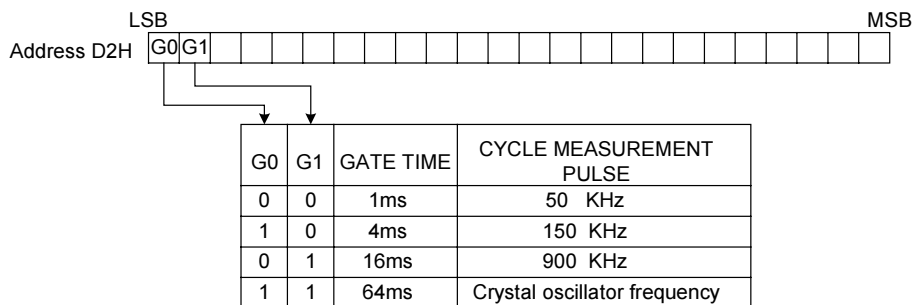

(2) Bits SC, IF1 and IF2 ... I/O port and general-purpose counter switching bits.

(*) The functions of the following pins are switched by data.

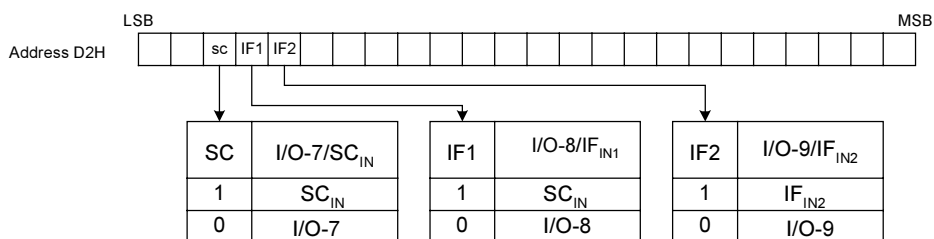

(3) Bits M7, M8 and M9 ... M7 sets the state for pin I/O-7/SCIN, M8 sets the state for pin I/O-8/IFIN1; M9, for pin I/O-9/IFIN2.

These operations are valid when bits SC, IF1 and IF2 are all set to 1.

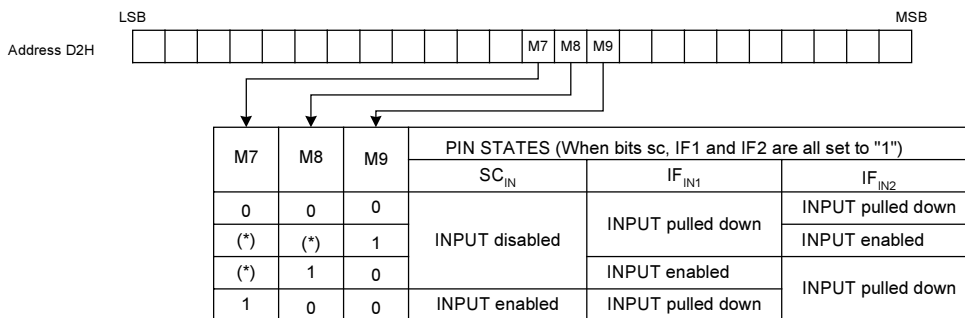

Note: Bits marked with an asterisk “(*)” are don't care

(4) Bits f0~f9...The general-purpose counter results can be read in binary from bits f0~f9 of the output register (D1H).

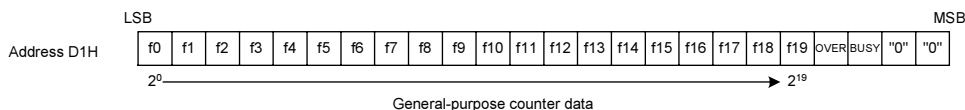

(5) OVER and BUSY bits...Detect the operating state of the general-purpose counter.

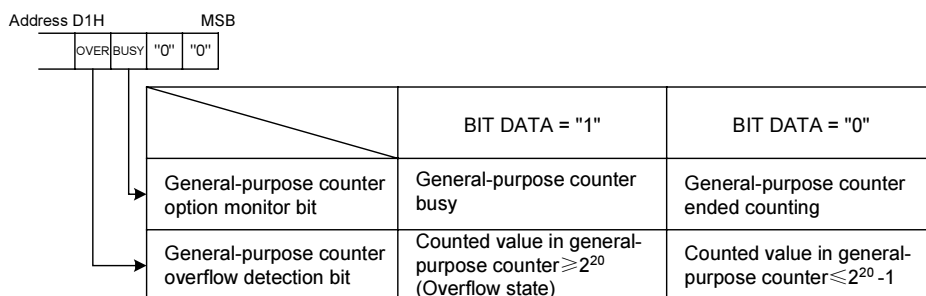

Note: When using the general-purpose counter, before referring to the contents of the general-purpose counter result bit (f0~f9), confirm that the busy bit is "0" (counting is ended) and the OVER bit is "0" (general-purpose counter data are normal).

(6) START bit...When the data are set to "1", the general-purpose counter is reset then counting begins.

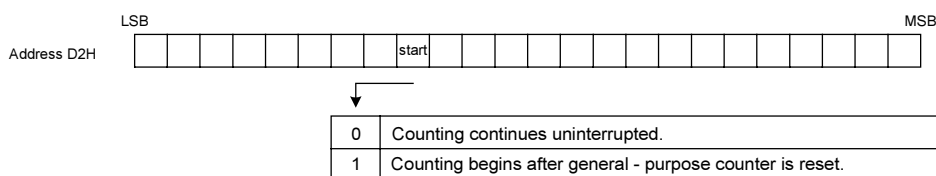

2. General-purpose counter circuit configuration

The general-purpose counter section consists of input amps, a gate time control circuit and a 20 bit binary counter.

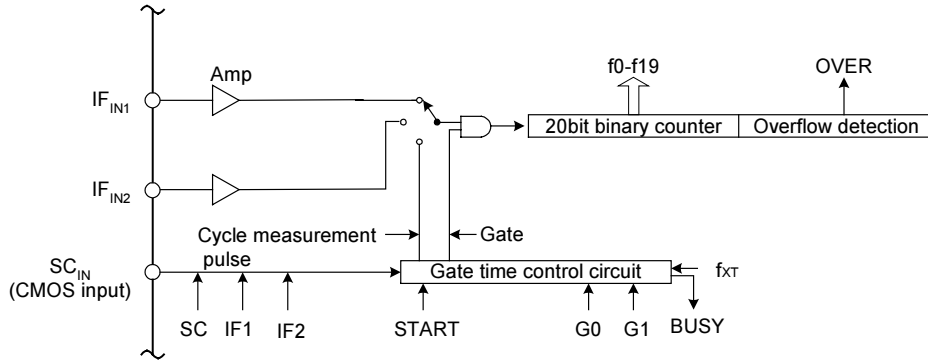
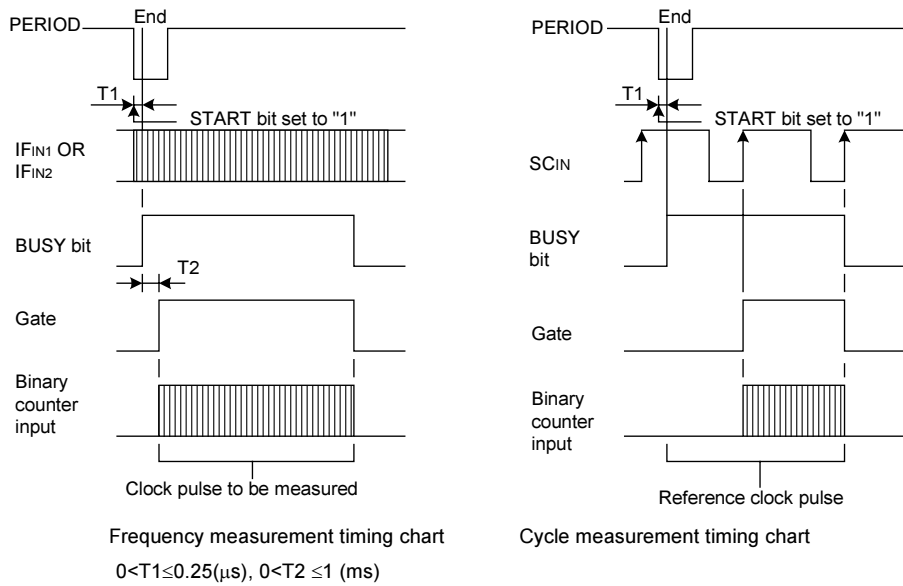

Fig.5

3. General-purpose counter measurement timing



- Note:**
1. IFIN1 and IFIN2 input have built-in amps. Data are input by capacitor coupling. FMIN and AMIN operate at low amplitude.
 2. SCIN is configured for CMOS input, so input signals should be logic level.

General-purpose I/O ports

These LSIs feature general-purpose output and I/O ports which are controlled through the serial ports.

Input/output form	port	Input/output configuration
Output port	Dedicated: 4 ports	N channel open-drain output
I/O ports	Dedicated: 1 port, Maximum: 5 ports	CMOS input/output

1. General-purpose output ports (OT-1~OT-4)

Pins OT-1~OT-4 are general-purpose dedicated output ports. They have such uses as control signal output. They are configured for N channel open-drain output and have an off withstanding voltage of 12V.

The data set in bits O1~O4 of the input register (D2H) are output in parallel from their correspond dedicated output port pins OT-1~OT-4.

The data set in bits O1~O4 of the input register (D2H) can also be read from the DATA pins as output register (D3H) serial data O1~O4.

(1) SC9257

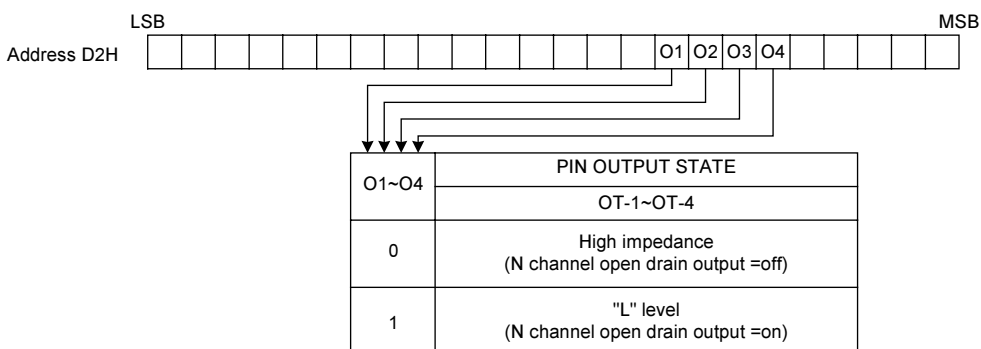

(2)output register ... The data set in bits O1~O4 of the input register can read as serial data O1~O4 from the output register (D3H).

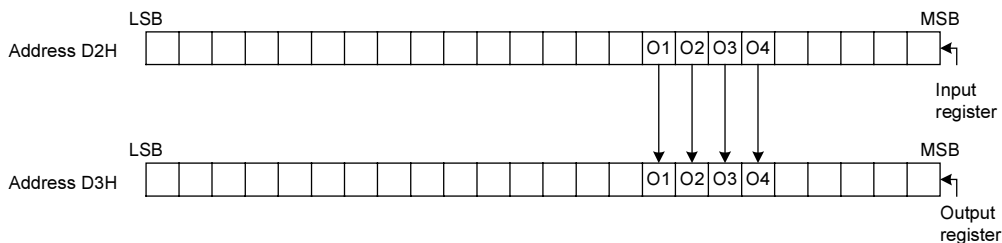

(2) Output register... Data which are set in bits C5, C6 and M7~M9 of the input register (D2H) can be read as serial data C5, C6 and M7~M9 from the output register (D3H).

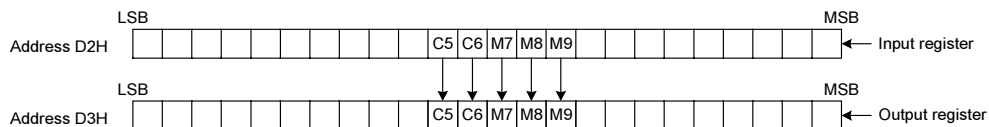

Data which are input in parallel from pins I/O -5~I/O-9 can be read as serial data I5~I9 from the output register (D3H)

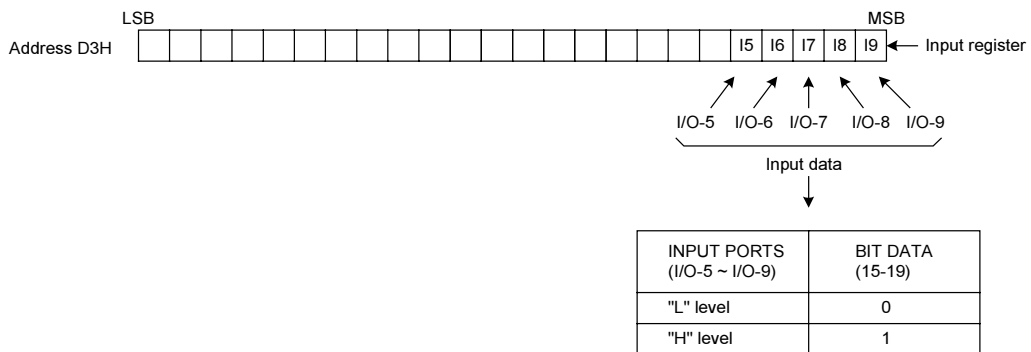

Note: 1. When pins I/O-5~I/O-9 are used for output, the data in I5~I9 of the output register(D3H) are undefined..
2. When power is turned on, input register (D2H) I/O port control bits C5, C6 and M7~M9 and output data bits O5~O9 are set to "0". General-purpose I/O ports are set as input ports. Pins which are used both as general-purpose I/O ports and for general-purpose counter input are set for I/O port input. The output state of general-purpose output ports is set to high impedance (N channel open drain output =off).

A typical example of data setting for general-purpose counter and I/O port use is shown below.

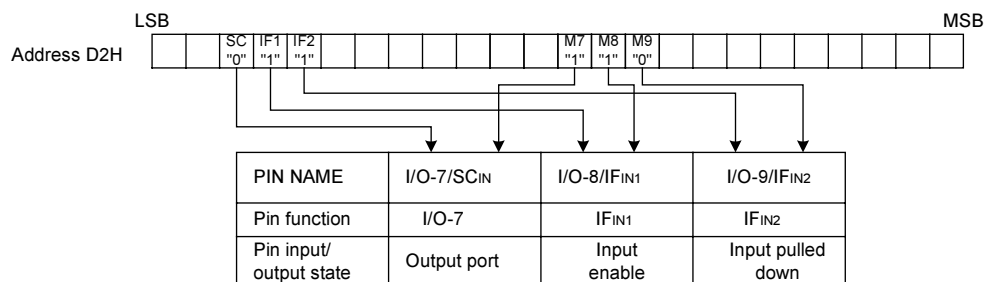

As shown above, the pins can be switched as necessary to enable use as an I/O port or general-purpose counter.

Phase comparator

The phase comparator outputs the phase error after comparing the phase difference of the reference frequency signal supplied by the reference counter and the divided output from the programmable counter. The frequencies and phase differences of these two signals are then equalized by passing them through low-pass filters. These signals then control the VCO.

The filter constants can be customized for FM and AM bands since the signals are output in parallel from the phase comparator then pass through the two tristate buffer pins, DO1 and DO2.

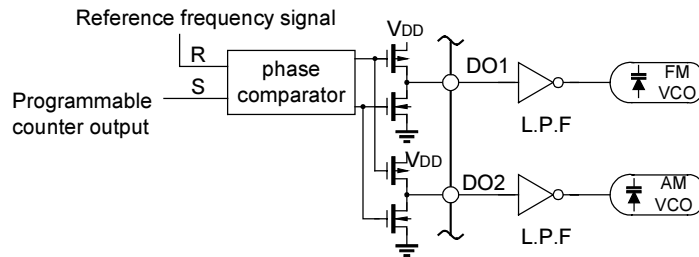

Fig.7

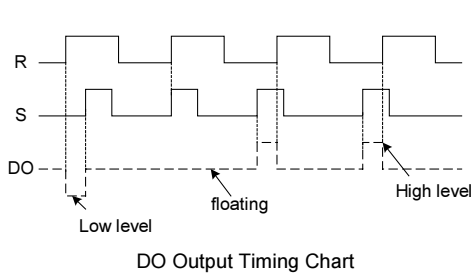
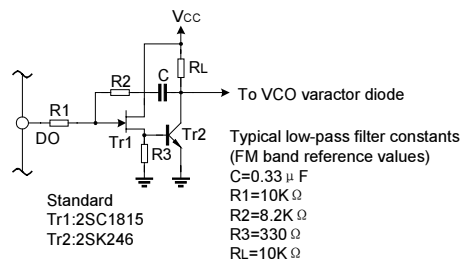

Fig.8



Typical Active Low-Pass Filter Circuit

Fig.9

The figures above show the DO output timing chart and a typical active low-pass filter circuit featuring a Darlington connection between the FET and transistor.

The filter circuit shown above is just one example. Actual circuits should be designed based on the band composition and the properties desired from the system.

Lock detection bits

The lock detection bits detect locked states in the PLL system. These systems have an unlock detection bit (unlock bit) which is used to detect, using the reference frequency cycle, the phase difference between the reference frequency and divided output of programmable counter. These systems also have phase error detection bits (bits PE1~PE3), which are capable of more precise detection ($\pm 0.55\mu\text{s} \sim \pm 7.15\mu\text{s}$).

1. Unlock detection bit (UNLOCK)

This bit detects, using the reference frequency cycle, the phase difference between the reference frequency and the divided output of the programmable counter. When there is no lock, that is, when the reference frequency and the divided output of the programmable counter are not the same, unlock F/F is set.

Unlock F/F is reset every time the input register (D2H) unlock reset bit (RESET) is set to "1". After unlock F/F has been reset in this way, locked state can detected by checking the unlock detection bit (UNLOCK) of the output register (D3H). After unlock F/F has been reset, the unlock detection bit must be checked after a time interval exceeding that of the reference frequency cycle has elapsed. This is because the reference frequency cycle inputs the lock detection strobe to unlock F/F. If the time interval is short, the correct locked state cannot be detected. Therefore, the output register (D3H) has a lock enable bit (ENABLE). This bit is reset every time the input register (D2H) reset bit is set to "1", and set to "1" through the lock detection timing. That is, the locked state is correctly detected when the lock enable bit (ENABLE) is "1".

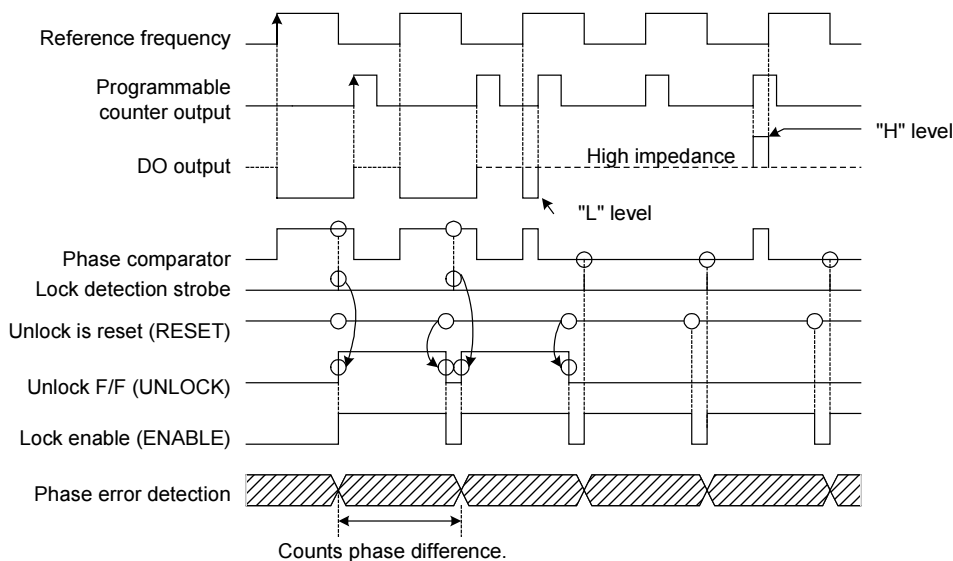
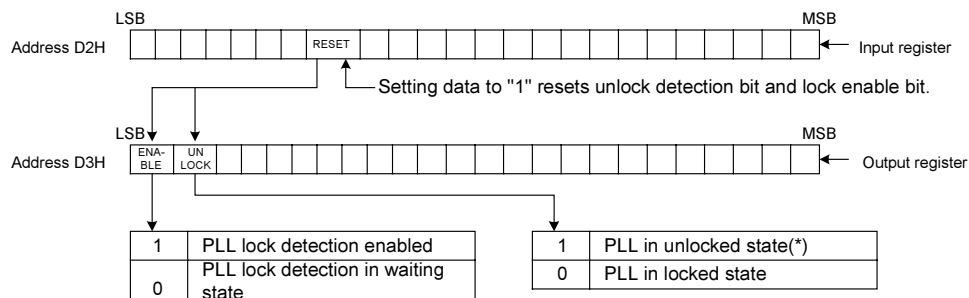

Fig.10



Note: The asterisk (*) indicates an error state of over 180° phase difference relative to the reference frequency

2. Phase error detection bits (PE1~PE3)

The unlock bit detects, using the reference frequency cycle, the phase difference between the reference frequency and the divided output of the programmable counter. The phase error detection bits (bits PE1~PE3) are capable of precise phase error detection of $\pm 0.55\mu s \sim \pm 7.15\mu s$ using the reference frequency cycle. (If the UNLOCK bit is set to "1" and the phase difference relative to the reference frequency is over 180°, bits PE1~PE3 cannot correctly detect the phase error. Therefore, bits PE1~PE3 are normally used when the UNLOCK bit is set to "0".) Bits PE1~PE3 detect phase error normally when the phase difference is $-180^\circ \sim 180^\circ$ relative to the reference frequency cycle.

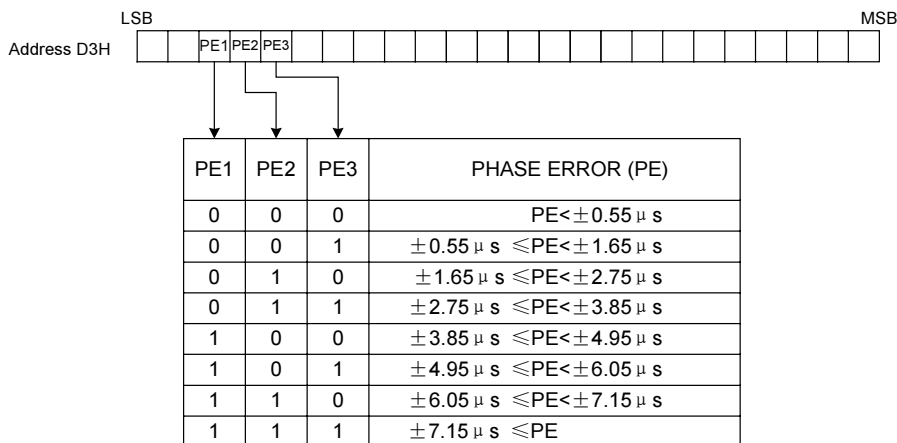

The phase error data can be read from the output register (D3H) as serial data PE1~PE3.

Following is a typical lock detection operation. It shows the operation flow from locked state to frequency change with a phase error greater than $\pm 6.05\mu\text{s}$.

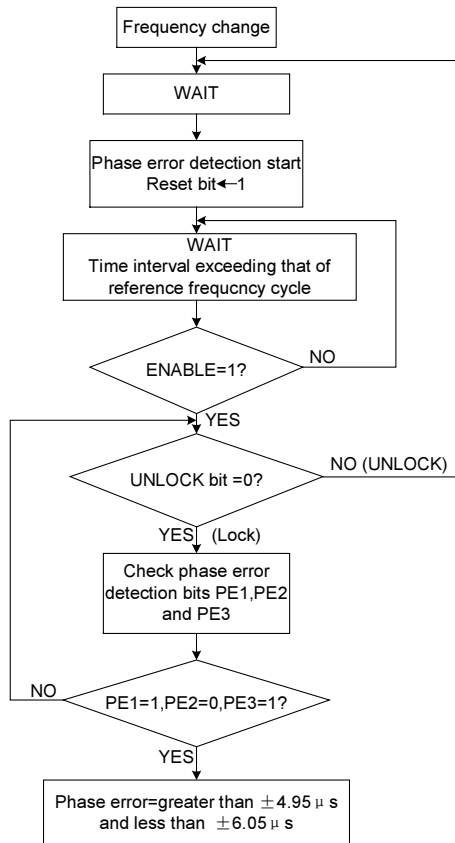
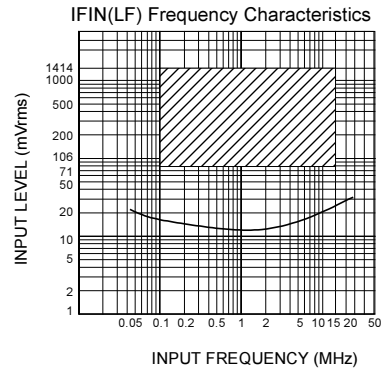
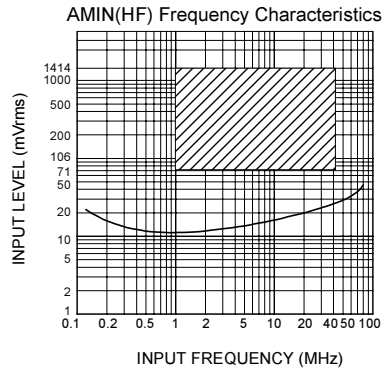
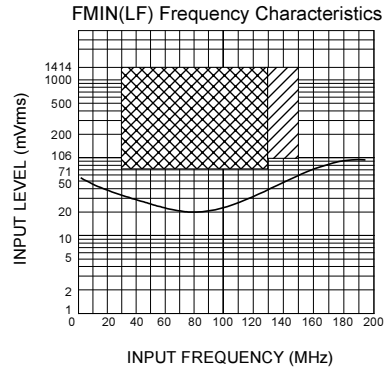
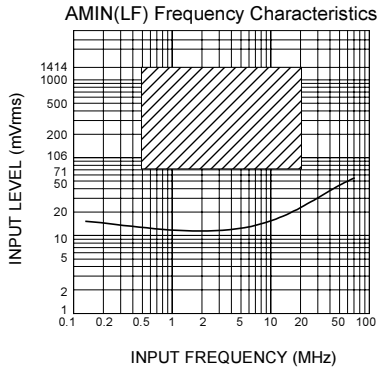







Fig.11

ELECTRICAL CHARACTERISTICS CURVE



(Note)  Operating Guarantee Range
($V_{DD}=4.5\sim 5.5V, T_a = -40 \sim 85^{\circ}C$)
 Standard Characteristics($V_{DD} = 5V, T_a = 25^{\circ}C$)

(Note)  $F_{MIN}:F_{MH}$
 +  $F_{MIN}:F_{ML}$ } Operating Guarantee Range
($V_{DD}=4.5\sim 5.5V, T_a = -40 \sim 85^{\circ}C$)
 Standard Characteristics($V_{DD} = 5V, T_a = 25^{\circ}C$)

APPLICATION CIRCUIT

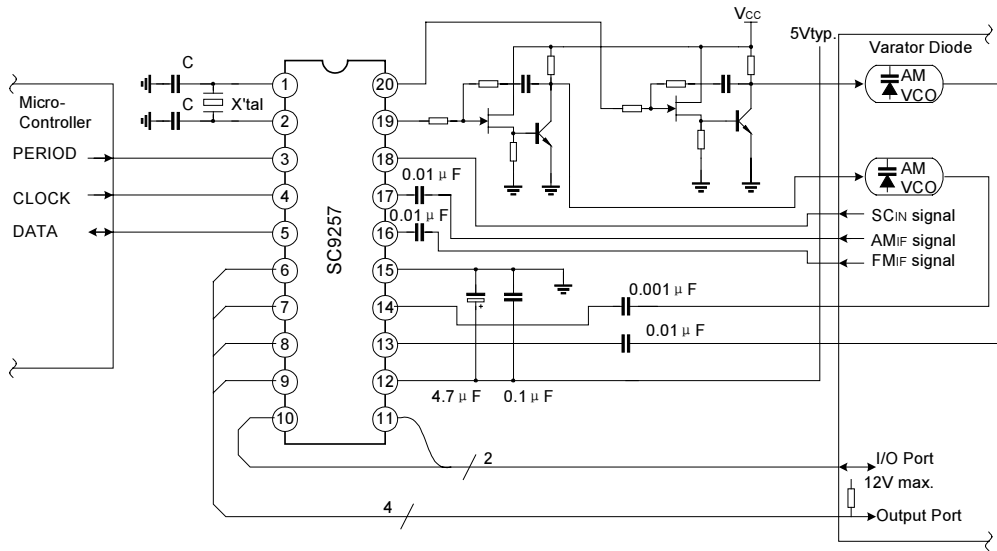

PACKAGE OUTLINE

