

3330, 3360, 3363

T-41-67

OPTOELECTRONIC SWITCHES

ULN3330/60/63T

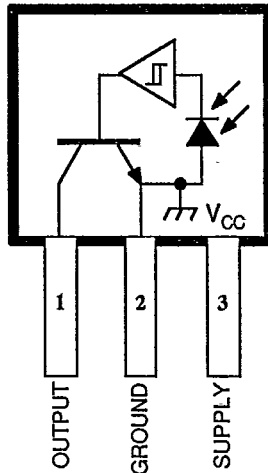

Dwg. PH-009

ABSOLUTE MAXIMUM RATINGS

Supply Voltage, V_{CC}	15 V
Output Voltage, V_{OUT}	15 V
Output Current, I_{OUT}	25 mA
Operating Temperature Range, T_A	-40°C to +70°C
Storage Temperature Range, T_S	-55°C to +110°C

The ULN3330T/TA, ULN3360T, and ULN3363T optoelectronic switches provide light detection and low-level signal processing in single three-lead packages. The monolithic integrated circuits, requiring no external components, meet the need for cost-effective, light-sensing devices in consumer and industrial applications. Their high sensitivity makes them ideal for low-level light detection in optically noise-free environments.

Each optoelectronic IC includes a 0.030" x 0.030" (0.76 x 0.76 mm) photodiode, a high-gain current amplifier, a comparator with 12% hysteresis, output driver stage, and voltage regulator.

The ULN3330T/TA and ULN3360T switches turn ON as illumination of the photodiode falls below 55 $\mu\text{W}/\text{cm}^2$ at 880 nm. An internal latch provides hysteresis: The output turns OFF when illumination exceeds the turn-on threshold by approximately 12%.

The ULN3363T switch has an inverted output characteristic. It turns OFF as illumination falls below 55 $\mu\text{W}/\text{cm}^2$ at 880 nm; it remains OFF until increasing illumination at the photodiode typically reaches 62 $\mu\text{W}/\text{cm}^2$.

The ULN3330T/TA and ULN3363T have buffered open-collector outputs for current-sink applications. Typical loads include incandescent lamps, LEDs, sensitive relays, or dc motors.

Output circuitry for the ULN3360T includes an internal 5.4 k Ω pull-up resistor that enables its direct use with microprocessors and TTL logic.

FEATURES

- Photodiode with:
 - On-Chip Amplifier
 - On-Chip Comparator with Hysteresis
 - On-Chip Power Driver
 - On-Chip Voltage Regulator
- Sensitive Switch Points
- Operation to 30 kHz

Always order by complete part number, e.g., **ULN3330T**.
See matrix on next page.

3330, 3360, 3363
OPTOELECTRONIC SWITCHES

T-41-67

ULN3330TA

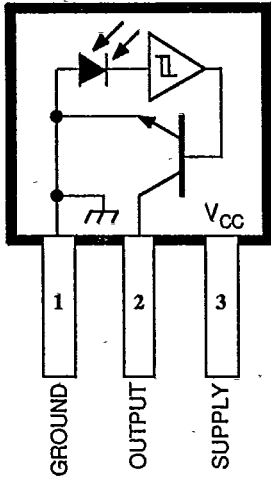

Dwg. PH-010

FUNCTIONAL BLOCK DIAGRAM

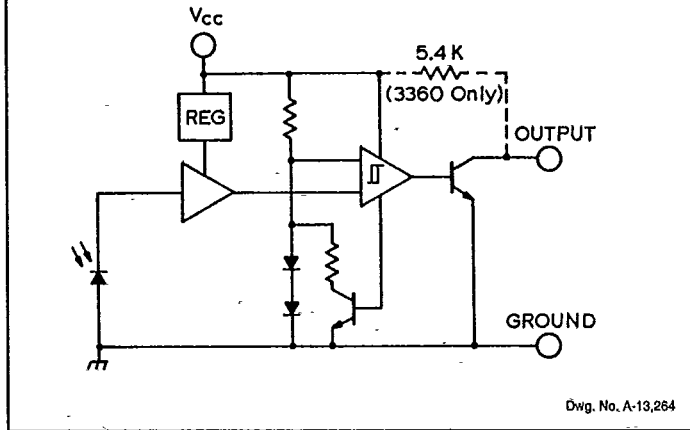

Dwg. No. A-13,264

Device Type	Output	Package	Pinout (1-2-3)
ULN3330T	Open Collector	T	OUT-GND-V _{CC}
ULN3330TA	Open Collector	TA	GND-OUT-V _{CC}
ULN3360T	5.4 kΩ Pull-Up	T	OUT-GND-V _{CC}
ULN3363T	Inv. Open Collector	T	OUT-GND-V _{CC}

ELECTRICAL CHARACTERISTICS at T_A = +25°C, V_{CC} = 6.0 V, λ = 880 nm

Characteristic	Symbol	Test Conditions	Limits			Units
			Min.	Typ.	Max.	
Supply Voltage Range	V _{CC}		4.0	6.0	15	V
Supply Current	I _{CC}		—	4.0	8.0	mA
Light Threshold Level	E _{ON}	Output ON	45	55	65	μW/cm ²
	E _{OFF}	Output OFF	—	62	—	μW/cm ²
Hysteresis	ΔE	(E _{OFF} - E _{ON})/E _{OFF}	10	13	16	%
Output ON Voltage	V _{OUT}	I _{OUT} = 15 mA	—	300	500	mV
		I _{OUT} = 25 mA	—	500	800	mV
Output OFF Current	I _{OUT}	V _{OUT} = 15 V	—	—	1.0	μA
Output Fall Time	t _f	90% to 10%	—	200	500	ns
Output Rise Time	t _r	10% to 90%	—	200	500	ns

**3330, 3360, 3363
OPTOELECTRONIC SWITCHES**

T-41-67

TYPICAL TRANSFER CHARACTERISTICS

ULN3330T/TA AND ULN3360T

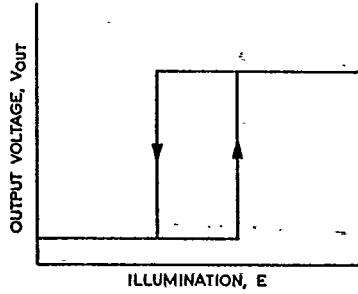

Dwg. No. A-11,128

ULN3363T

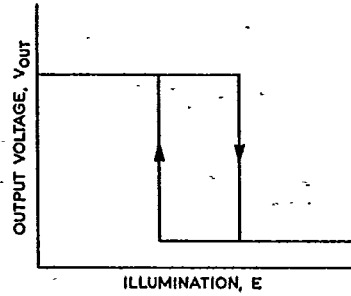

Dwg. No. A-13,265

SENSOR LOCATIONS

SUFFIX 'T'

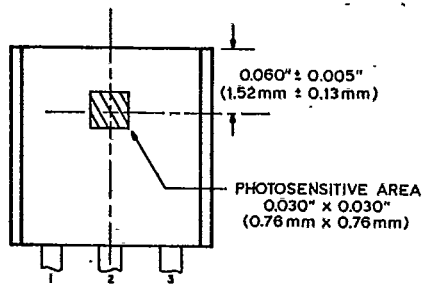

Dwg. No. A-13,301

SUFFIX 'TA'

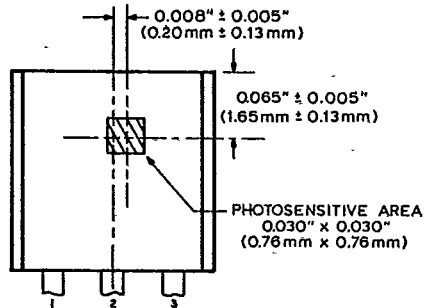

Dwg. No. A-11,994C

3330, 3360, 3363
OPTOELECTRONIC SWITCHES

T-41-67

**RELATIVE SPECTRAL RESPONSE AT $T_A = +25^\circ\text{C}$
 AS A FUNCTION OF WAVELENGTH OF LIGHT**

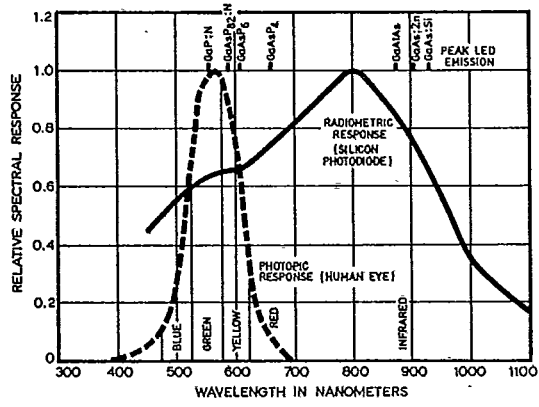

Dwg. No. A-12,135A

**OUTPUT SATURATION VOLTAGE AS A FUNCTION
 OF OPERATING TEMPERATURE**

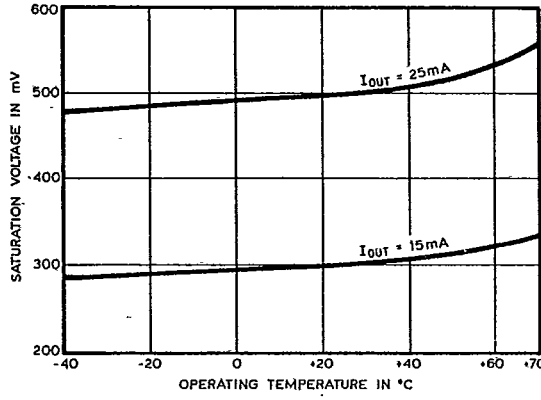

Dwg. No. A-12,307

**PROPAGATION DELAY
 AS A FUNCTION OF LIGHT LEVEL**

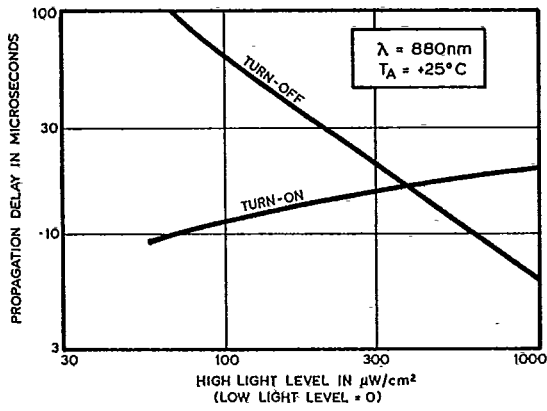

Dwg. No. A-12,308

**LIGHT-THRESHOLD CHANGE AS A FUNCTION
 OF OPERATING TEMPERATURE**

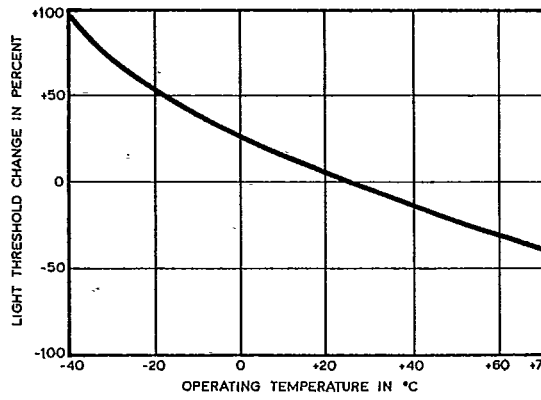

Dwg. No. A-12,309

3330, 3360, 3363
OPTOELECTRONIC SWITCHES

T-41-67

TYPICAL APPLICATIONS*

BAR CODE READER

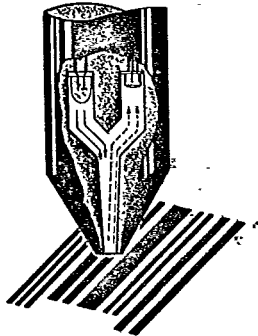

Dwg. No. A-13,266

OPTICAL ISOLATOR

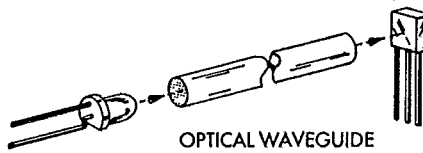

Dwg. No. A-13,267

SHEET DETECTOR

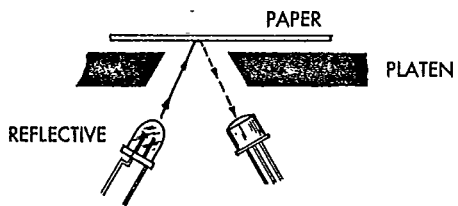

Dwg. No. A-13,268

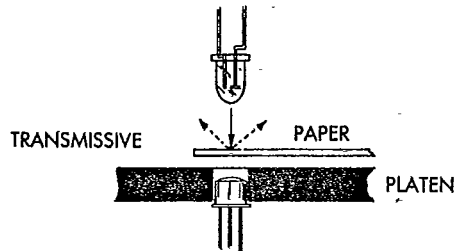

Dwg. No. A-13,269

OPTICAL ENCODER

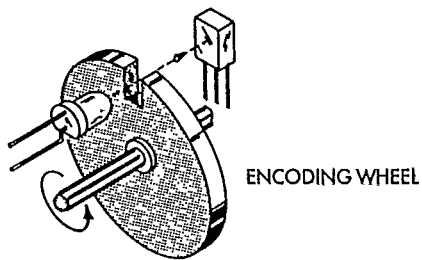

Dwg. No. A-13,270

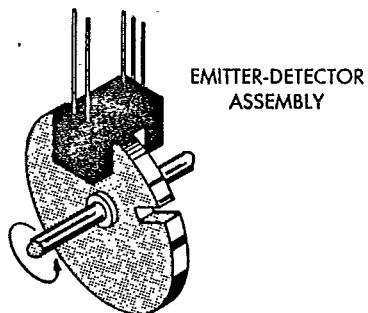

Dwg. No. A-13,271

*Optics and ambient light shields omitted for clarity.