

MICROWAVE LOW NOISE AMPLIFIER
NPN SILICON EPITAXIAL
TRANSISTOR

DESCRIPTION

The 2SC4536 is designed for use in middle power, low distortion low noise figure RF amplifier. It features excellent linearity and large dynamic range, which make it suitable for CATV, telecommunication, and other use, it employs plastic surface mount type package (SOT-89).

FEATURES

- Low Distortion
 $IM_2 = 57.5 \text{ dB TYP. @ } V_{CE} = 10 \text{ V, } I_c = 50 \text{ mA}$
 $IM_3 = 82 \text{ dB TYP. @ } V_{CE} = 10 \text{ V, } I_c = 50 \text{ mA}$
- Low Noise
 $NF = 1.5 \text{ dB TYP. @ } V_{CE} = 10 \text{ V, } I_c = 10 \text{ mA, } f = 1 \text{ GHz}$
- Power Mini Mold Package Used. → High Power Dissipation.

ABSOLUTE MAXIMUM RATINGS ($T_A = 25 \text{ }^\circ\text{C}$)

Maximum Voltage and Current ($T_A = 25 \text{ }^\circ\text{C}$)

Collector to Base Voltage	V_{CB0}	30	V
Collector to Emitter Voltage	V_{CE0}	15	V
Emitter to Base Voltage	V_{EB0}	3.0	V
Collector Current	I_c	250	mA

Maximum Power Dissipation

Total Power Dissipation			
at 25 °C Ambient Temperature P_T^*	2.0	W	

Maximum Temperatures

Junction Temperature	T_j	150	°C
Storage Temperature Range	T_{stg}	-65 to +150	°C

* 0.7 mm × 16 cm² double sided ceramic substrate. (Copper plating)

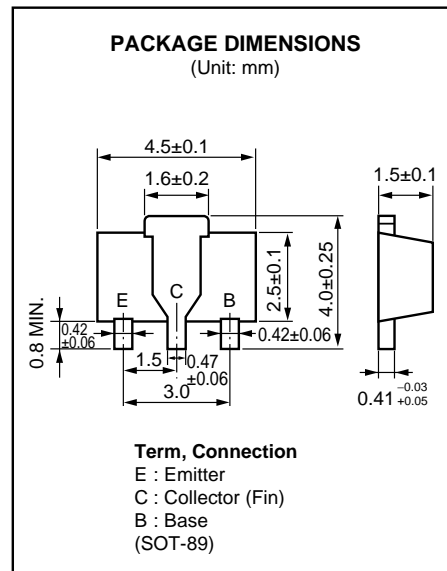

ELECTRICAL CHARACTERISTICS (T_A = 25 °C)

CHARACTERISTIC	SYMBOL	MIN.	TYP.	MAX.	UNIT	TEST CONDITIONS
Collector Cutoff Current	I _{CBO}			5.0	μA	V _{CB} = 20 V, I _E = 0
Emitter Cutoff Current	I _{EB0}			5.0	μA	V _{EB} = 2 V, I _C = 0
DC Current Gain	h _{FE}	40		200		V _{CE} = 10 V, I _C = 50 mA
Insertion Power Gain	S _{21e} ²	5.5	7.3		dB	V _{CE} = 10 V, I _C = 50 mA, f = 1 GHz ^{*1}
Noise Figure 1	NF ₁		1.5		dB	V _{CE} = 10 V, I _C = 50 mA, f = 500 MHz ^{*2}
Noise Figure 2	NF ₂		2.0		dB	V _{CE} = 10 V, I _C = 50 mA, f = 1 GHz ^{*2}
2nd Intermodulation Distortion	IM ₂		59.0		dB	V _{CE} = 10 V, I _C = 50 mA, R _S = R _L = 75 Ω Pin = 105 dBμV/75 Ω, f ₁ = 190 MHz f ₂ = 90 MHz, f = f ₁ - f ₂
3rd Intermodulation Distortion	IM ₃		82.0		dB	V _{CE} = 10 V, I _C = 50 mA, R _S = R _L = 75 Ω Pin = 105 dBμV/75 Ω, f ₁ = 190 MHz f ₂ = 200 MHz, f = 2 × f ₁ - f ₂

*1 Pulsed: PW ≤ 350 μs, Duty Cycle ≤ 2 %

*2 R_s = R_L = 50 Ω, untuned

h_{FE} Classification

Class	QQ	QR	QS
Marking	QQ	QR	QS
h _{FE}	40 to 80	60 to 120	100 to 200

TYPICAL CHARACTERISTICS (T_A = 25 °C)

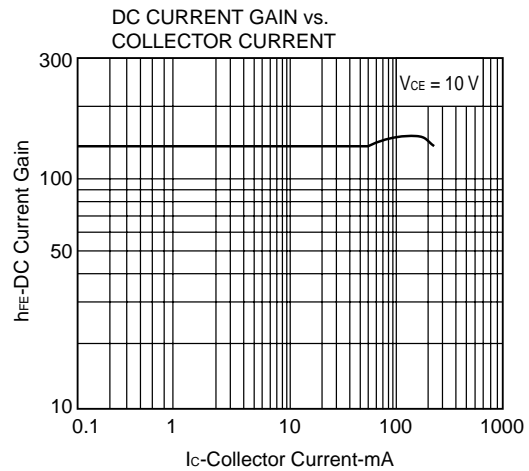
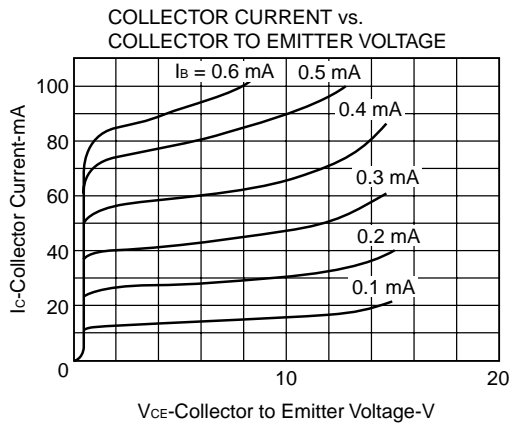

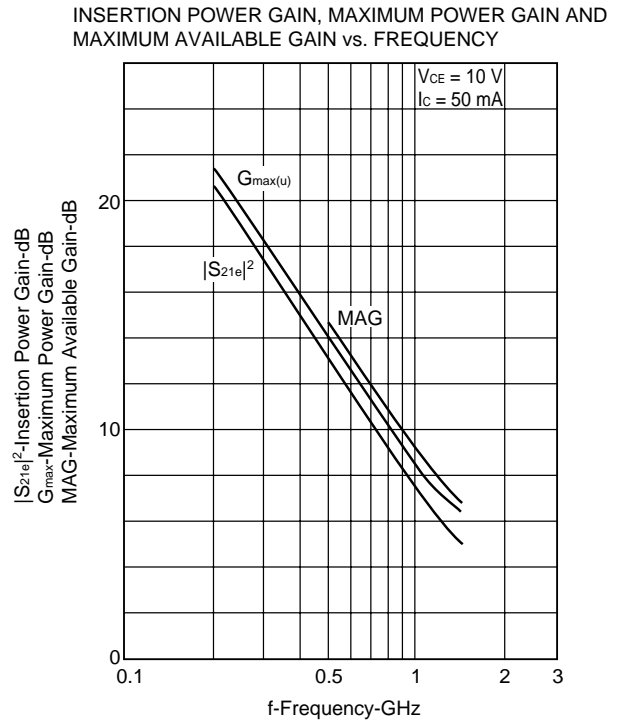
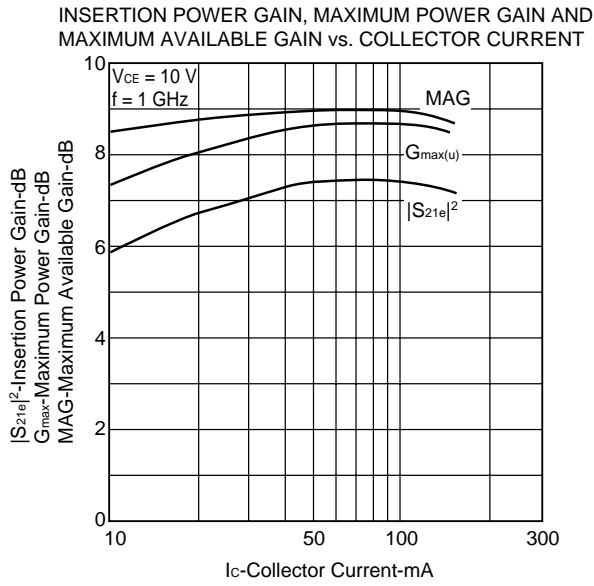
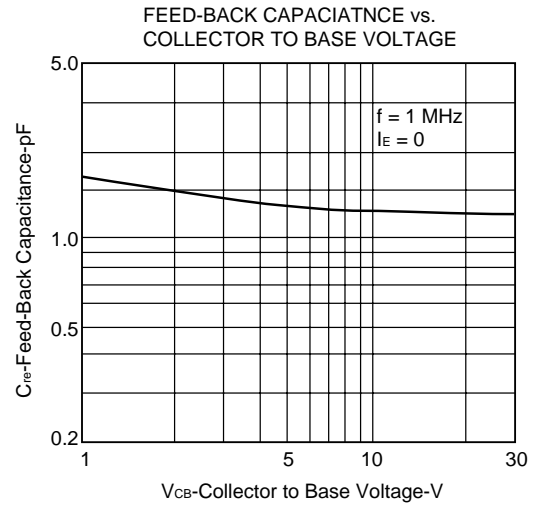
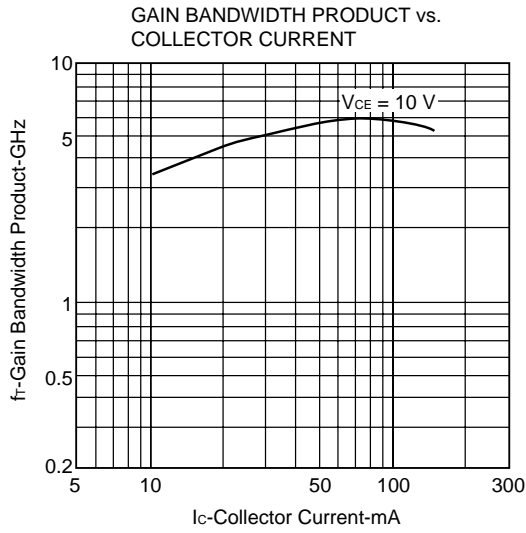

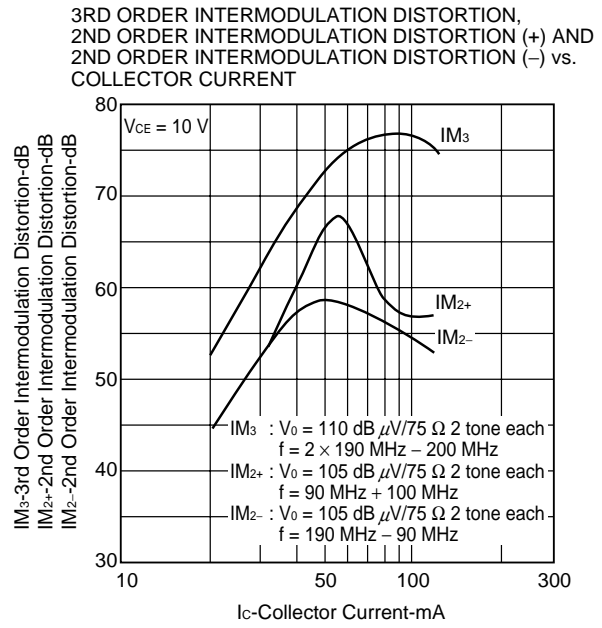
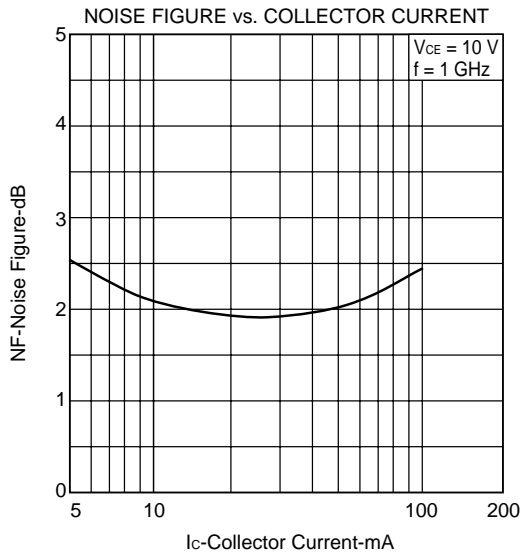

S-PARAMETER

2SC4536 10V 50 mA

FREQUENCY		S ₁₁		S ₂₁		S ₁₂		S ₂₂	
MHz	MAG	ANG	MAG	ANG	MAG	ANG	MAG	ANG	
100.00	0.455	-139.5	19.845	103.5	0.033	59.9	0.359	-92.5	
200.00	0.425	-164.6	10.155	93.1	0.057	65.8	0.211	-113.9	
300.00	0.419	-177.2	7.482	86.4	0.085	65.7	0.184	-126.8	
400.00	0.422	175.9	5.341	78.5	0.100	63.8	0.173	-138.5	
500.00	0.431	167.7	4.356	75.3	0.125	67.5	0.174	-140.9	
600.00	0.425	162.2	3.612	71.2	0.148	65.7	0.175	-146.8	
700.00	0.445	155.2	3.271	68.1	0.179	64.1	0.176	-150.6	
800.00	0.435	151.7	2.843	61.6	0.194	60.6	0.179	-152.4	
900.00	0.470	146.4	2.497	58.6	0.210	61.2	0.191	-157.3	
1000.00	0.442	142.1	2.292	56.5	0.237	60.6	0.186	-157.7	
1100.00	0.468	138.1	2.163	51.9	0.270	57.8	0.196	-160.9	
1200.00	0.451	132.3	1.982	48.1	0.285	54.6	0.203	-162.5	
1300.00	0.477	129.4	1.816	44.4	0.296	53.3	0.220	-165.7	
1400.00	0.478	124.2	1.712	43.7	0.315	53.8	0.221	-168.8	
1500.00	0.492	122.1	1.701	38.6	0.349	49.7	0.237	-170.9	
1600.00	0.490	116.9	1.538	35.7	0.355	47.3	0.230	-172.1	
1700.00	0.503	115.8	1.489	32.6	0.375	44.5	0.255	-174.8	
1800.00	0.505	111.9	1.399	32.0	0.382	44.9	0.260	-177.1	
1900.00	0.512	109.3	1.445	28.2	0.424	42.2	0.276	-178.7	
2000.00	0.522	105.4	1.291	24.3	0.414	39.4	0.269	175.9	

2SC4536 10V 100 mA

FREQUENCY		S ₁₁		S ₂₁		S ₁₂		S ₂₂	
MHz	MAG	ANG	MAG	ANG	MAG	ANG	MAG	ANG	
100.00	0.458	-145.3	20.257	101.0	0.035	53.6	0.333	-100.7	
200.00	0.423	-169.1	10.259	91.6	0.059	71.2	0.207	-123.1	
300.00	0.417	179.5	7.545	85.5	0.084	67.2	0.181	-136.8	
400.00	0.422	173.6	5.390	78.0	0.103	65.6	0.179	-147.4	
500.00	0.431	165.5	4.387	74.8	0.126	68.1	0.180	-148.8	
600.00	0.422	160.6	3.633	70.9	0.149	67.1	0.185	-154.0	
700.00	0.445	153.7	3.290	67.8	0.183	65.1	0.185	-157.9	
800.00	0.432	150.5	2.864	61.6	0.197	60.4	0.188	-159.2	
900.00	0.466	145.2	2.514	58.6	0.215	62.6	0.199	-163.7	
1000.00	0.440	140.9	2.306	56.5	0.242	60.5	0.195	-163.9	
1100.00	0.465	137.1	2.177	52.0	0.274	57.9	0.203	-167.3	
1200.00	0.450	131.3	1.994	48.2	0.289	54.6	0.210	-168.5	
1300.00	0.472	128.6	1.830	44.6	0.300	52.8	0.228	-170.8	
1400.00	0.473	123.5	1.723	44.0	0.321	53.2	0.228	-173.3	
1500.00	0.490	121.5	1.713	38.9	0.357	49.2	0.246	-176.1	
1600.00	0.485	116.5	1.549	35.9	0.359	46.6	0.234	-178.0	
1700.00	0.500	115.0	1.498	32.8	0.379	44.1	0.259	-179.9	
1800.00	0.500	111.2	1.411	32.3	0.387	44.6	0.264	178.3	
1900.00	0.509	108.5	1.455	28.4	0.431	41.8	0.279	176.2	
2000.00	0.516	104.9	1.302	24.4	0.418	38.4	0.273	171.0	

[MEMO]

[MEMO]

No part of this document may be copied or reproduced in any form or by any means without the prior written consent of NEC Corporation. NEC Corporation assumes no responsibility for any errors which may appear in this document.

NEC Corporation does not assume any liability for infringement of patents, copyrights or other intellectual property rights of third parties by or arising from use of a device described herein or any other liability arising from use of such device. No license, either express, implied or otherwise, is granted under any patents, copyrights or other intellectual property rights of NEC Corporation or others.

While NEC Corporation has been making continuous effort to enhance the reliability of its semiconductor devices, the possibility of defects cannot be eliminated entirely. To minimize risks of damage or injury to persons or property arising from a defect in an NEC semiconductor device, customers must incorporate sufficient safety measures in its design, such as redundancy, fire-containment, and anti-failure features.

NEC devices are classified into the following three quality grades:

"Standard", "Special", and "Specific". The Specific quality grade applies only to devices developed based on a customer designated "quality assurance program" for a specific application. The recommended applications of a device depend on its quality grade, as indicated below. Customers must check the quality grade of each device before using it in a particular application.

Standard: Computers, office equipment, communications equipment, test and measurement equipment, audio and visual equipment, home electronic appliances, machine tools, personal electronic equipment and industrial robots

Special: Transportation equipment (automobiles, trains, ships, etc.), traffic control systems, anti-disaster systems, anti-crime systems, safety equipment and medical equipment (not specifically designed for life support)

Specific: Aircrafts, aerospace equipment, submersible repeaters, nuclear reactor control systems, life support systems or medical equipment for life support, etc.

The quality grade of NEC devices is "Standard" unless otherwise specified in NEC's Data Sheets or Data Books. If customers intend to use NEC devices for applications other than those specified for Standard quality grade, they should contact an NEC sales representative in advance.

Anti-radioactive design is not implemented in this product.