

Description

The function of this low reset Type IC is to accurately reset systems after detecting the supply voltage at the time of switching power on and instantaneous power off in various CPU and other logic system. Further, this IC, with its super low consumption current is most suited as a voltage check circuit for a number of products which use batteries.

Features

- Super low current consumption ($I_{CCL} = 1.0\mu A$ Typ.)
- High current of output transistor ($I_{OL} = 20mA$ Typ.)
- Hysteresis circuit built in ($\Delta V_S = 100mV$ Typ.)
- It has on delay function to supplement the constant of outer C and R.

Applications

- Reset circuits for microcomputers, CPU and MPU.
- Reset circuit for logic circuitry.
- Battery voltage check circuit.
- Circuit for changing over to backup battery.
- Level detecting circuit.

Ordering Information

Type NO.	Marking	Package Code
S72NxxUF	N□□	SOT-323F

□□: Detecting Voltage Code

Outline Dimensions

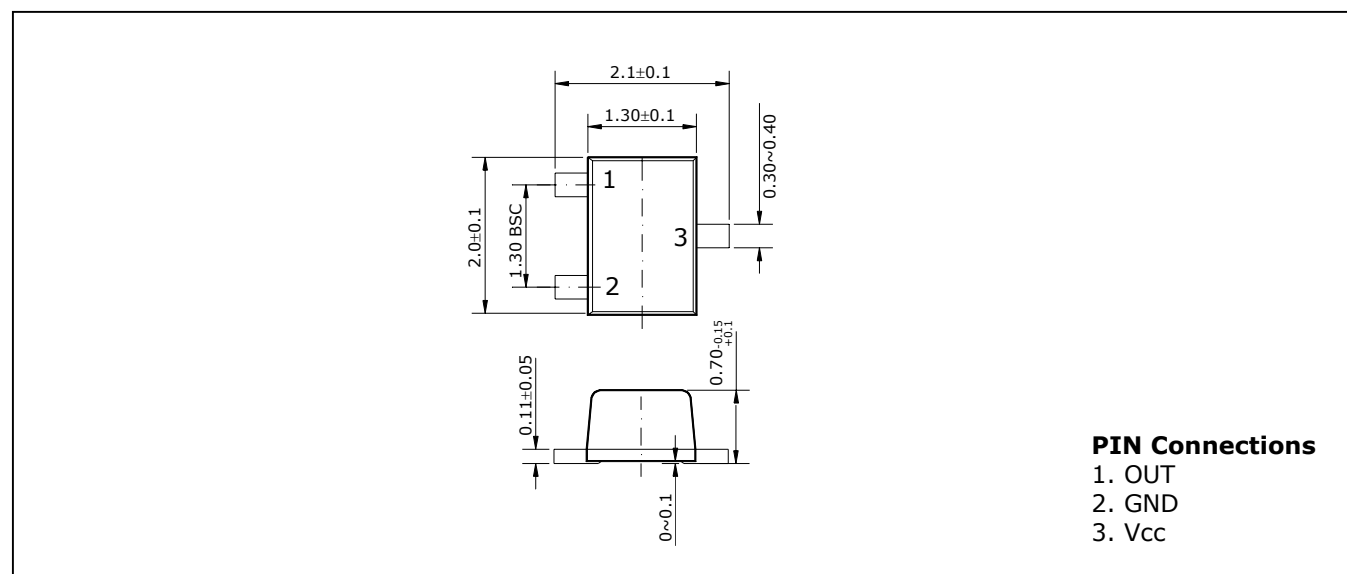

Equivalent Circuit Diagram

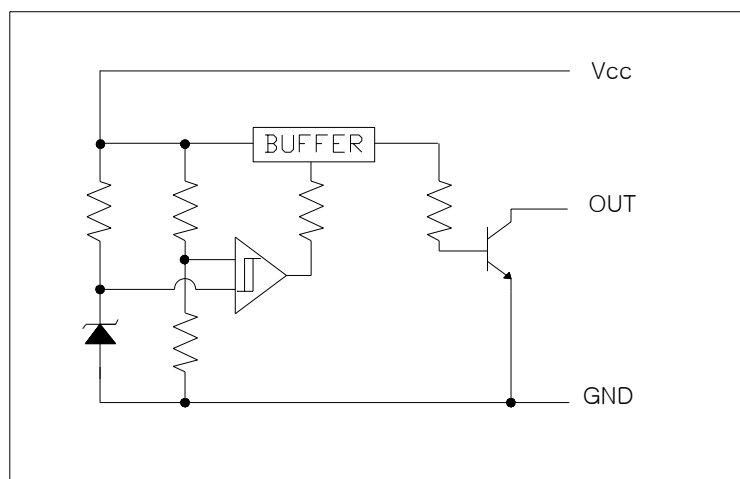

Maximum ratings

(Ta=25°C)

Characteristic	Symbol	Ratings	Unit
Supply voltage	Vcc	-0.3 ~ +10	V
Power Dissipation (Package Limitation)	PD *	200	mW
Operating Temperature	Topr	-20 ~ +75	°C
Storage Temperature	Tstg	-40 ~ +125	°C

* With PCB(8×8 mm Copper Area) at Glass Epoxy Board (t=1.7 mm, Area; 20×20 mm)

Electrical Characteristics

(Vcc=5V, Ta=25°C)

Characteristic	Symbol	Test Circuit	Test Condition	Min.	Typ.	Max.	Unit
Detecting Voltage	VS	1	* See Table 1				
Hysteresis Voltage	Δ VS	1	RL=470Ω, VCC=L→H→L	40	100	300	mV
Temperature Coefficient Of detecting voltage	VS/Δ T	1	RL=470Ω, Ta= -20~75°C	-	±0.01	-	%/°C
Low Level Output voltage	VOL	1	RL=470Ω, VCC= VS Min	-	0.1	0.4	V
Circuit current at ON	ICCL	1	RL=∞Ω, VCC= VS Min	-	100	180	μA
Circuit current at OFF	ICCH	1	RL=∞Ω, VCC=VS Max +0.1V	-	1.0	2.5	μA
Threshold Operating Voltage	Vopr	1	RL=4.7 kΩ, VOL ≤ 0.4V	-	1.4	1.6	V
Output Current at ON I	IOL 1	1	RL=0Ω, VCC= VS Min	10	20	-	mA
Output Current at ON II	IOL 2	1	RL=0Ω, VCC= VS Min, Ta= -20~75°C	5	-	-	mA
L→H Transmission delay time	tPLH	2	RL=4.7 kΩ, CL=100 pF	-	100	500	μs
H→L Transmission delay time	tPHL	2	RL=4.7 kΩ, CL=100 pF	-	10	20	μs

*** Table 1**

Electrical Characteristics

(Vcc=5V, Ta=25°C)

Characteristic	Symbol	Test Circuit	Test Condition	Min.	Typ.	Max.	Unit	
Detecting voltage	VS	1	RL=470Ω VCC=H→L VOL ≤ 0.4V	S72N45UF	4.30	4.5	4.70	V
				S72N42UF	4.00	4.2	4.40	
				S72N39UF	3.70	3.9	4.10	
				S72N36UF	3.40	3.6	3.80	
				S72N33UF	3.10	3.3	3.50	
				S72N31UF	2.90	3.1	3.30	
				S72N29UF	2.75	2.9	3.05	
				S72N27UF	2.55	2.7	2.85	
				S72N25UF	2.35	2.5	2.65	
				S72N23UF	2.15	2.3	2.45	

Test Circuit 1

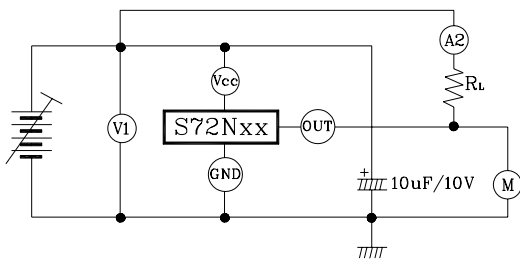

Test Circuit 2

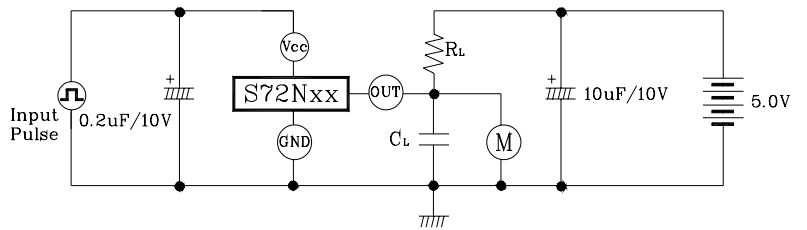

Application Circuit

(1) Battery Low Indicator

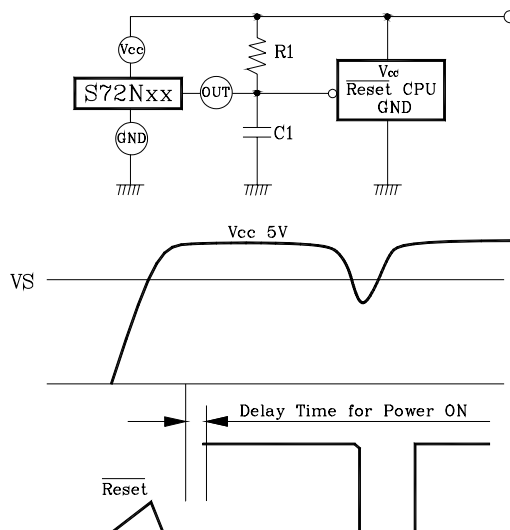
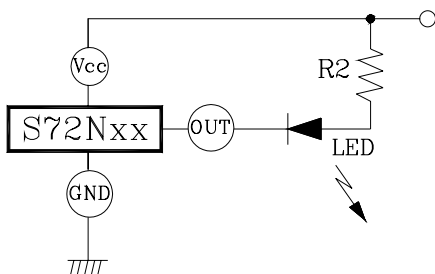

(Note)

- (1) Connecting of LED and R2 obtains a voltage drop indicator.
- (2) Connecting of C1 and selection of time constant with C1 and R1 set the power on delay time.

Electrical Characteristic Curves

Fig. 1 $V_O - V_{CC}$

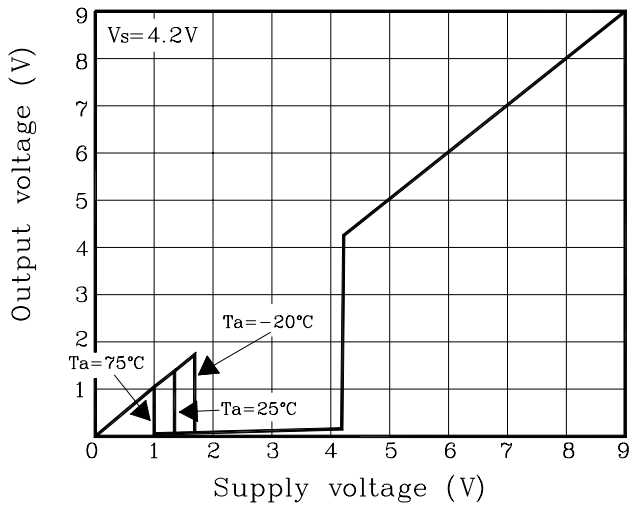

Fig. 2 $I_{CC} - V_{CC}$

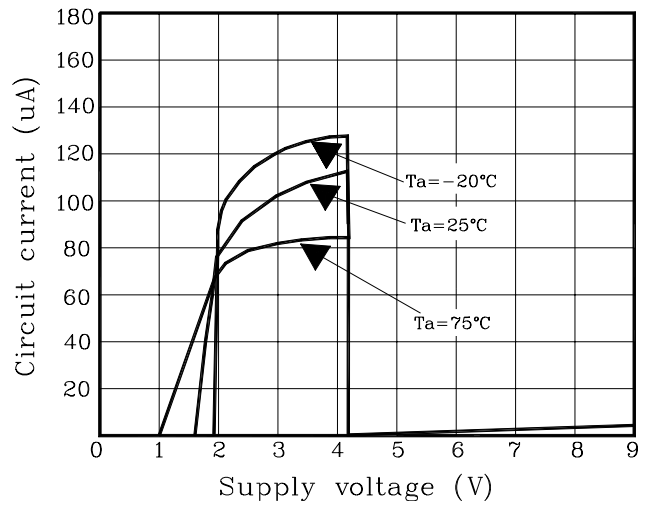

Fig. 3 $\Delta V_S - T_a$

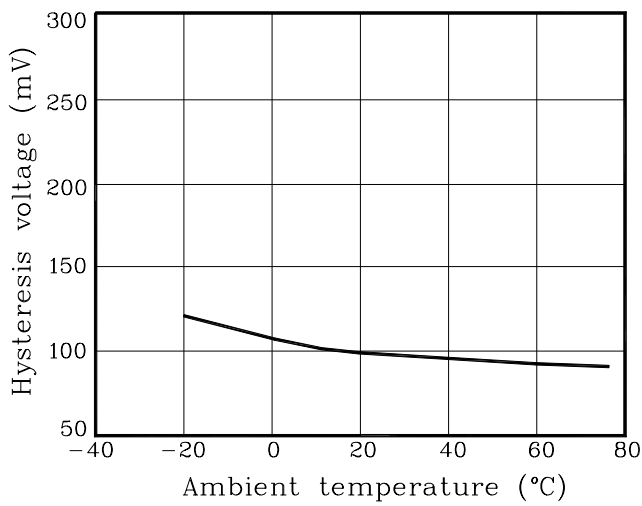

Fig. 4 $V_S - T_a$

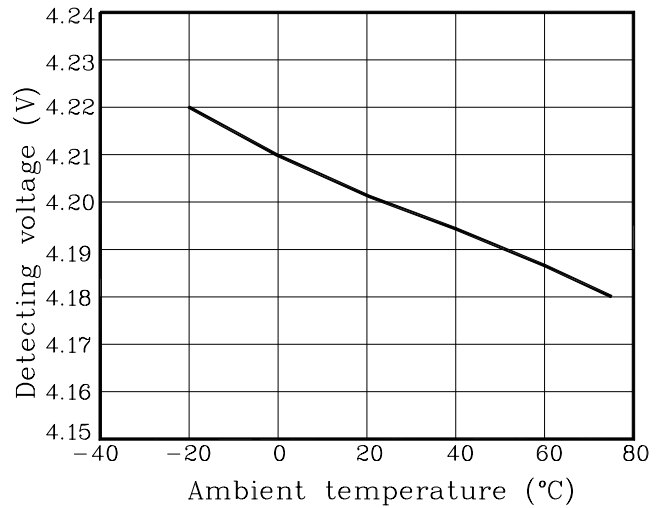

Fig. 5 $I_{CCL} - T_a$

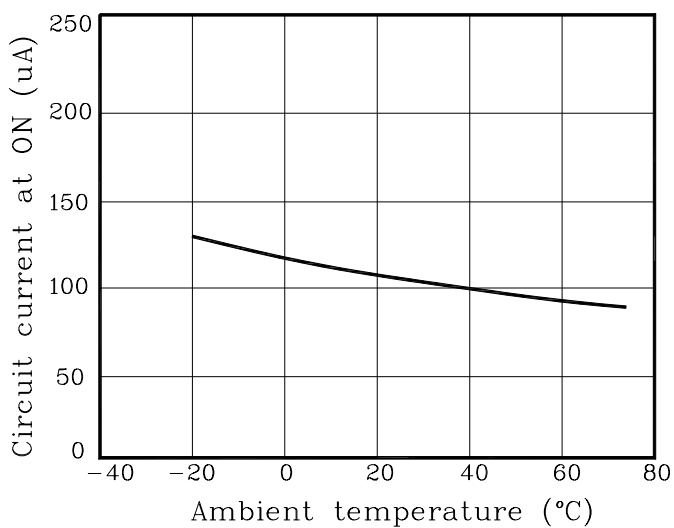

Fig. 6 $V_{OL} - T_a$

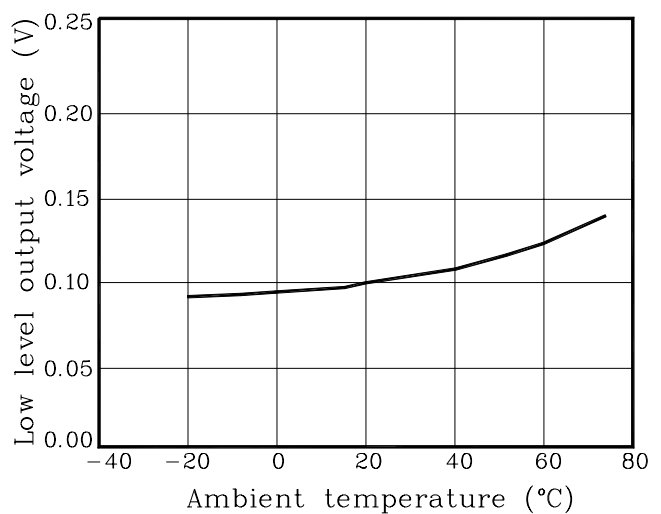

Fig. 7 $I_{OL} - T_a$

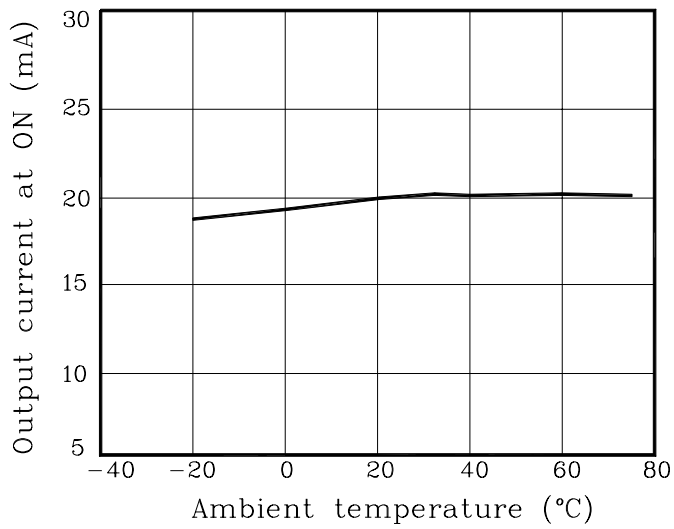

Fig. 8 $I_{CCH} - T_a$

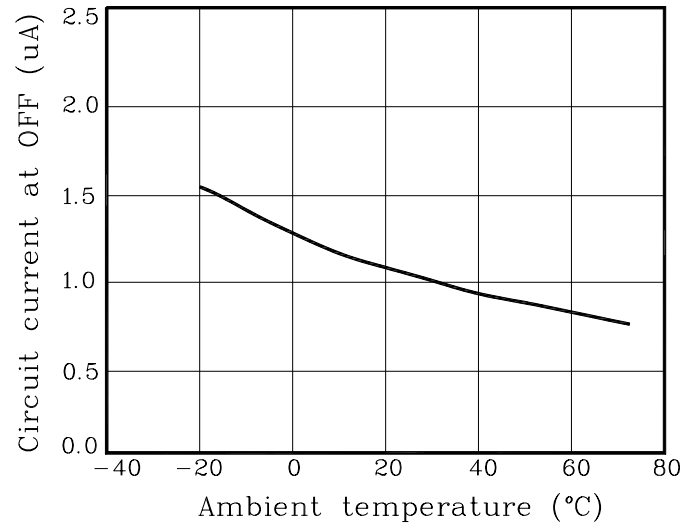
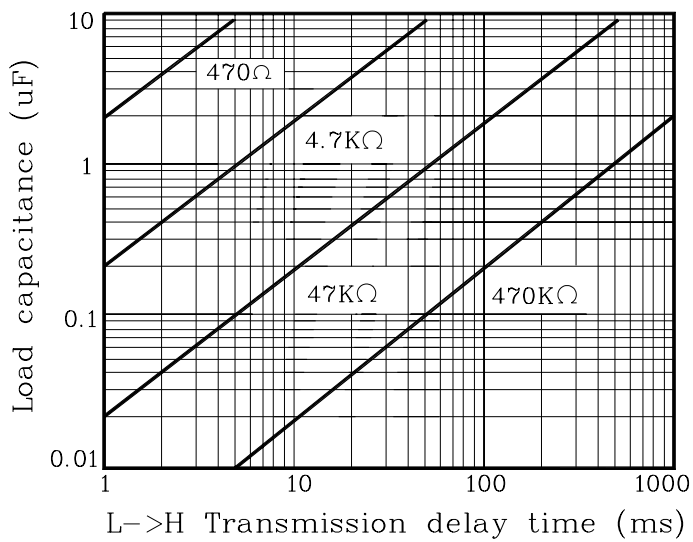

Fig. 9 $C_L - t_{PLH}$



These AUK products are intended for usage in general electronic equipments(Office and communication equipment, measuring equipment, domestic electrification, etc.).

Please make sure that you consult with us before you use these AUK products in equipments which require high quality and/or reliability, and in equipments which could have major impact to the welfare of human life(atomic energy control, airplane, spaceship, traffic signal, combustion central, all types of safety device, etc.).

AUK cannot accept liability to any damage which may occur in case these AUK products were used in the mentioned equipments without prior consultation with AUK.