

Intelligent Power Module (R-Series)

Maximum Ratings and Characteristics

Absolute Maximum Ratings ($T_c=25^\circ\text{C}$)

Items	Symbols	Ratings		Units
		Min.	Max.	
DC Bus Voltage	V_{DC}	0	900	V
DC Bus Voltage (surge)	$V_{DC(Surge)}$	0	1000	
DC Bus Voltage (short operating)	V_{SC}	200	800	
Collector-Emitter Voltage	V_{CES}	0	1200	
Inverter Collector Current	Continuous	I_C	75	A
	1ms	I_{CP}	150	
	Duty=62.6%	$-I_C$	75	
Collector Power Dissipation (One Transistor)	P_C		595	W
Voltage of Power Supply for Driver	V_{CC}	0	20	V
Input Signal Voltage	V_{IN}	0	V_Z	V
Input Signal Current	I_{IN}		1	mA
Alarm Signal Voltage	V_{ALM}	0	V_{CC}	V
Alarm Signal Current	I_{ALM}		15	mA
Junction Temperature	T_j		150	°C
Operating Temperature	T_{OP}	-20	100	
Storage Temperature	T_{stg}	-40	125	
Isolation Voltage	A.C. 1min. V_{iso}		2500	
Screw Torque	Mounting *1		3.5	Nm
	Terminals *1		3.5	

Note: *1: Recommendable Value; 2.5 – 3.0 Nm (M5)

Outline Drawing

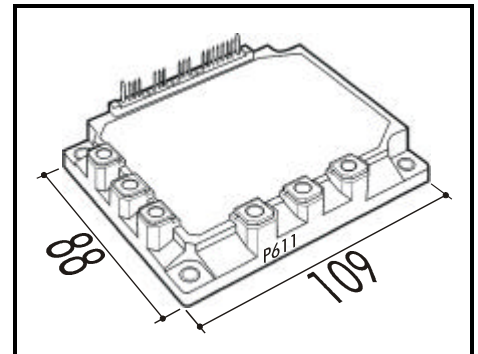

Electrical Characteristics of Power Circuit (at $T_j=25^\circ\text{C}$, $V_{CC}=15\text{V}$)

Items		Symbols	Conditions	Min.	Typ.	Max.	Units
INV	Collector Current At Off Signal Input	I_{CES}	$V_{CE}=1200\text{V}$, Input Terminal Open			1.0	mA
	Collector-Emitter Saturation Voltage	$V_{CE(Sat)}$	$I_C=75\text{A}$			2.6	V
	Forward Voltage of FWD	V_F	$-I_C=75\text{A}$			3.0	V

Electrical Characteristics of Control Circuit (at $T_j=25^\circ\text{C}$, $V_{CC}=15\text{V}$)

Items		Symbols	Conditions	Min.	Typ.	Max.	Units
Current of P-Line Side Driver (One Unit)		I_{CCP}	$f_{SW}=0\sim 15\text{kHz}$, $T_c=-20\sim 100^\circ\text{C}$	3		18	mA
Current of N-Line Side Driver (Three Units)		I_{CCN}	$f_{SW}=0\sim 15\text{kHz}$, $T_c=-20\sim 100^\circ\text{C}$	10		65	
Input Signal Threshold Voltage		$V_{IN(th)}$	On	1.00	1.35	1.70	V
			Off	1.25	1.60	1.95	
Input Zener Voltage		V_Z	$R_{IN}=20\text{k}\Omega$		8.0		
Over Heating Protection Temperature Level		T_{COH}	$V_{DC}=0\text{V}$, $I_C=0\text{A}$, Case Temp.	110		125	°C
Hysteresis		T_{CH}			20		
IGBT Chips Over Heating Protec. Temp. Level		T_{jOH}	Surface Of IGBT Chip	150			
Hysteresis		T_{jH}			20		
Inverter Collector Current Protection Level		I_{OC}	$T_j=125^\circ\text{C}$	113			A
Over Current Detecting Time		t_{DOC}	$T_j=25^\circ\text{C}$		10		μs
Alarm Signal Hold Time		t_{ALM}		1.5	2		ms
Limiting Resistor for Alarm		R_{ALM}		1425	1500	1575	Ω
Under Voltage Protection Level		V_{UV}		11.0		12.5	V
Hysteresis		V_H		0.2			

Dynamic Characteristics (at $T_c=T_j=125^\circ\text{C}$, $V_{CC}=15\text{V}$)

Items		Symbols	Conditions	Min.	Typ.	Max.	Units
Switching Time		t_{ON}	$I_C=50\text{A}$, $V_{DC}=600\text{V}$	0.3			μs
		t_{OFF}				3.6	
		t_{RR}	$I_F=50\text{A}$, $V_{DC}=600\text{V}$			0.4	

Thermal Characteristics

Items		Symbols	Conditions	Min.	Typ.	Max.	Units
Thermal Resistance		$R_{th(i-c)}$	Inverter IGBT			0.21	°C/W
		$R_{th(i-c)}$	Diode			0.47	
		$R_{th(c-f)}$	With Thermal Compound		0.05		

■ Equivalent Circuit

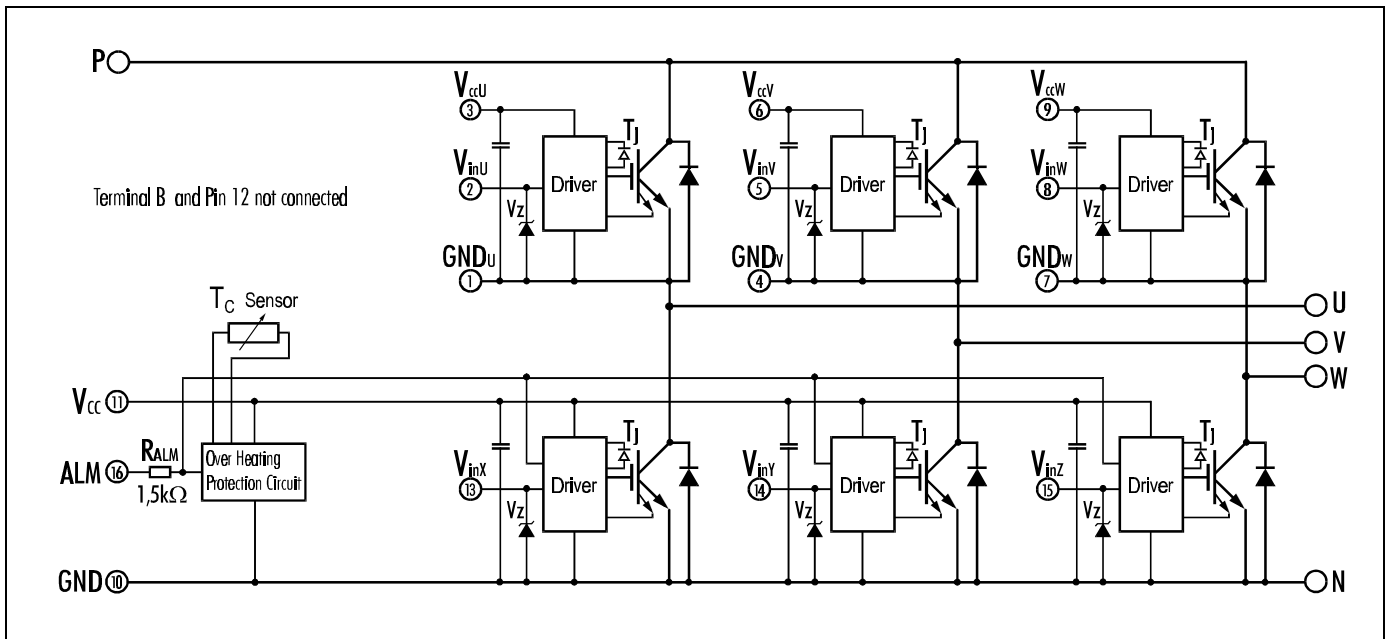

Drivers include following functions

- Short circuit protection circuit
- Amplifier for driver
- Undervoltage protection circuit
- Overcurrent protection circuit
- IGBT Chip overheating protection

Control Circuit

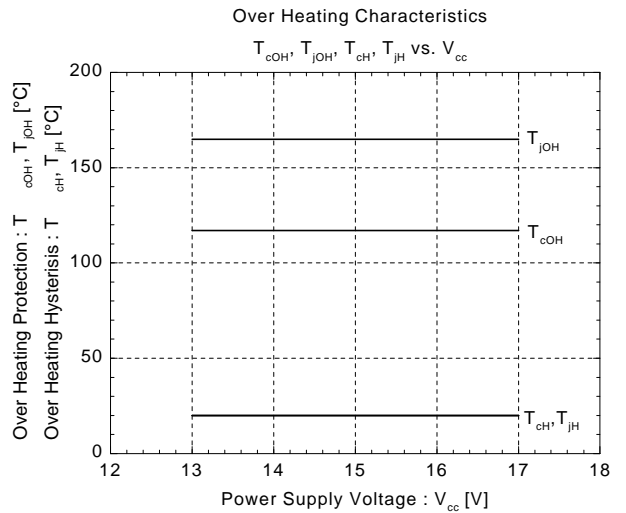
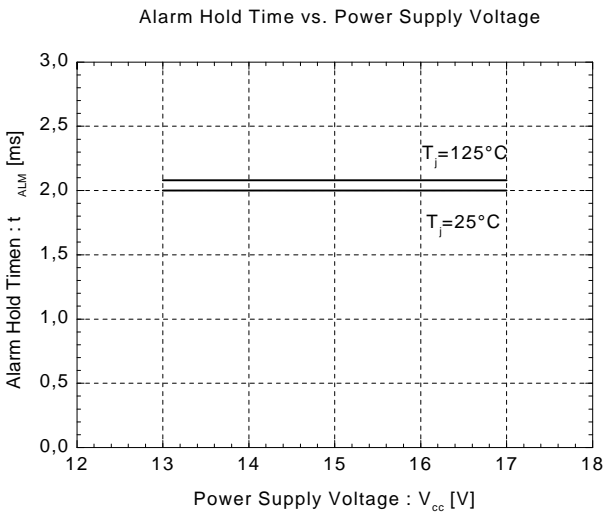
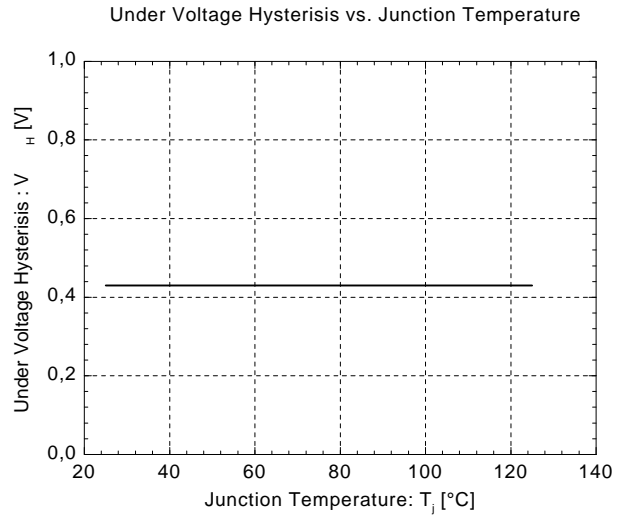
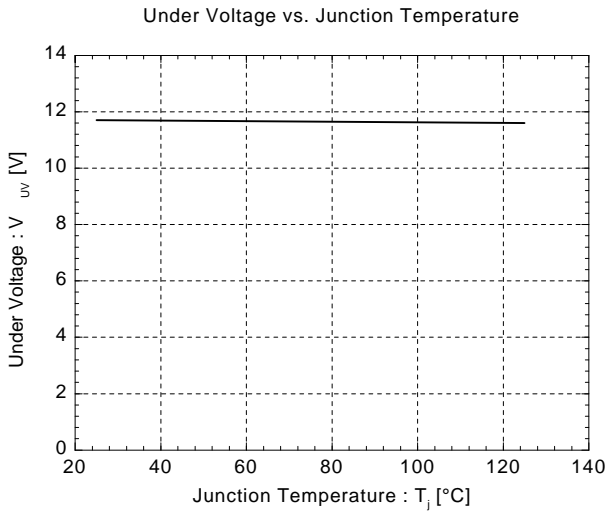
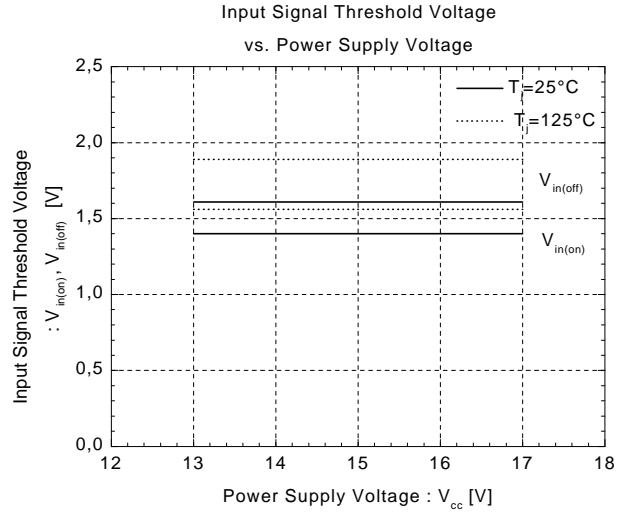
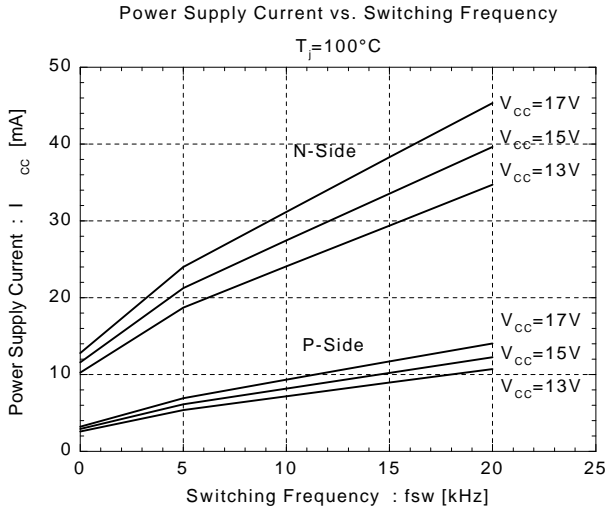

■ Inverter

Collector Current vs. Collector-Emitter Voltage

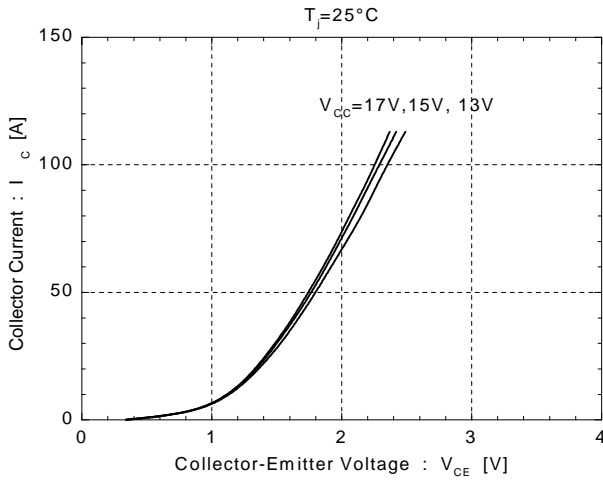

Collector Current vs. Collector-Emitter Voltage

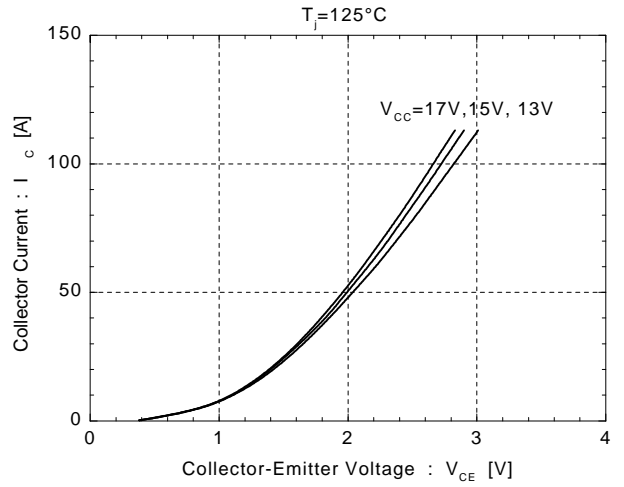

Switching Time vs. Collector Current

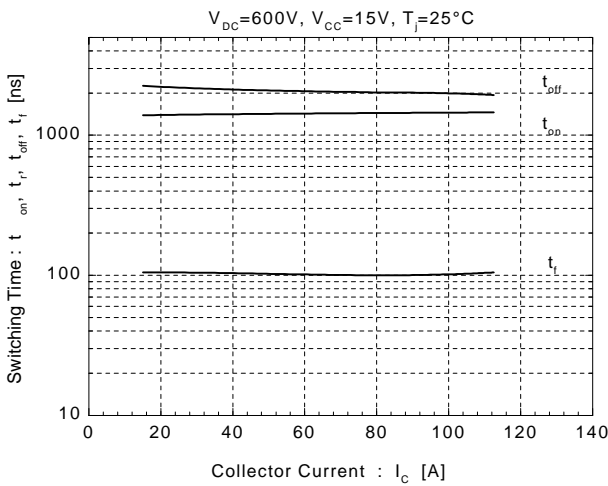

Switching Time vs. Collector Current

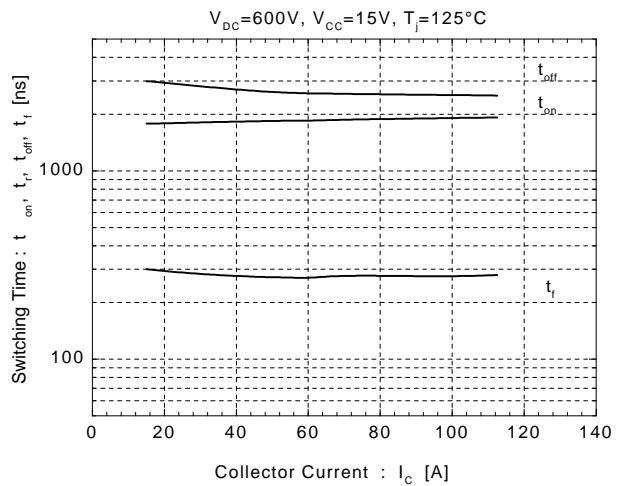

Forward Voltage vs. Forward Current

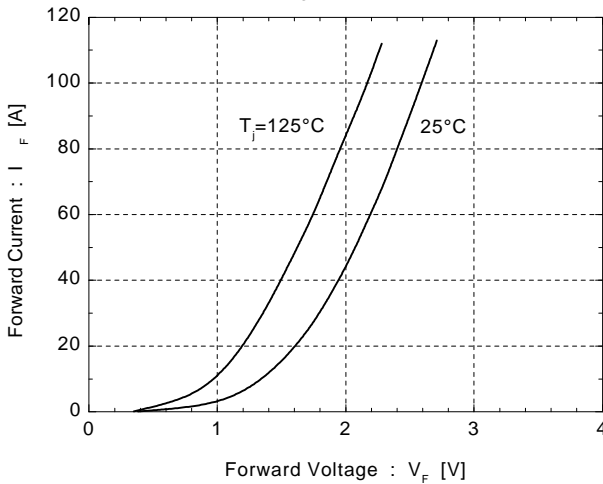

Switching Loss vs. Collector Current

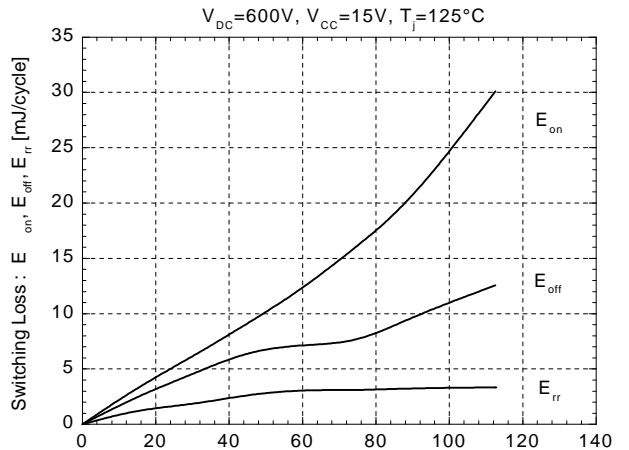

■ Inverter

Transient Thermal Resistance

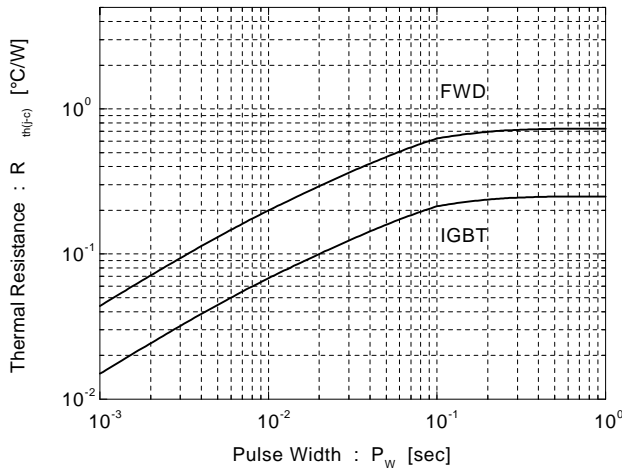

Reverse Biased Safe Operating Area

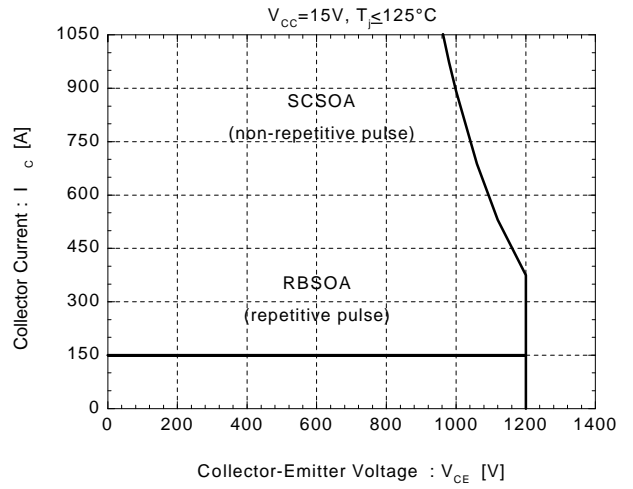

Power Derating For IGBT
(per device)

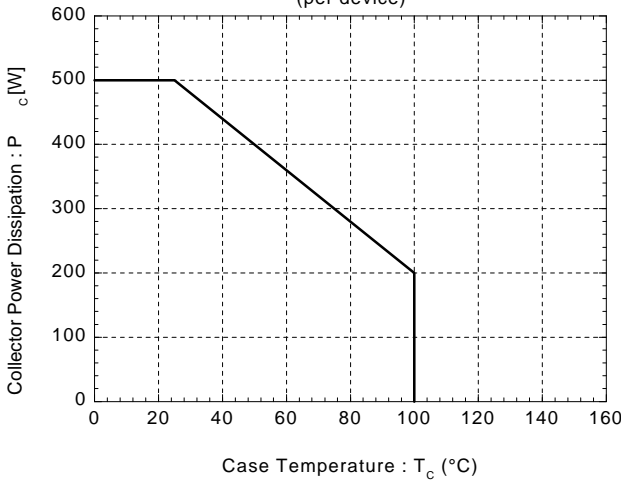

Power Derating For FWD
(per device)

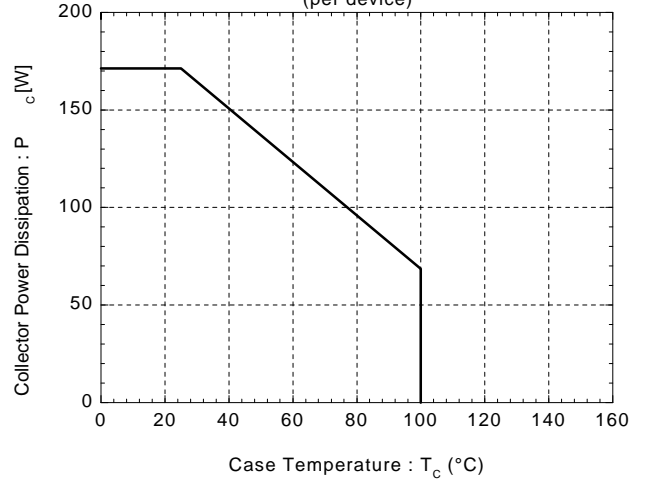

Switching Loss vs. Collector Current

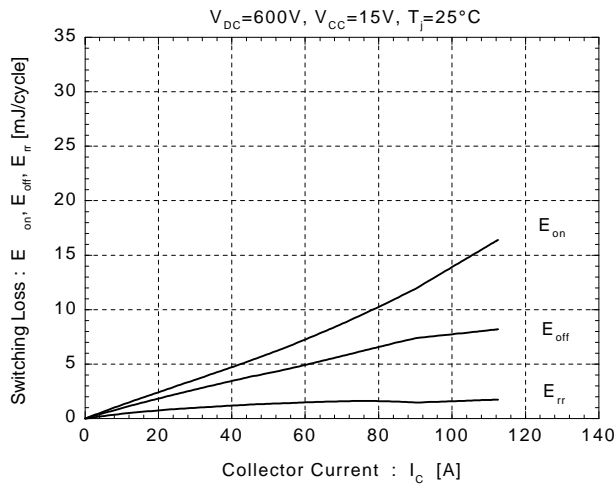

Switching Loss vs. Collector Current

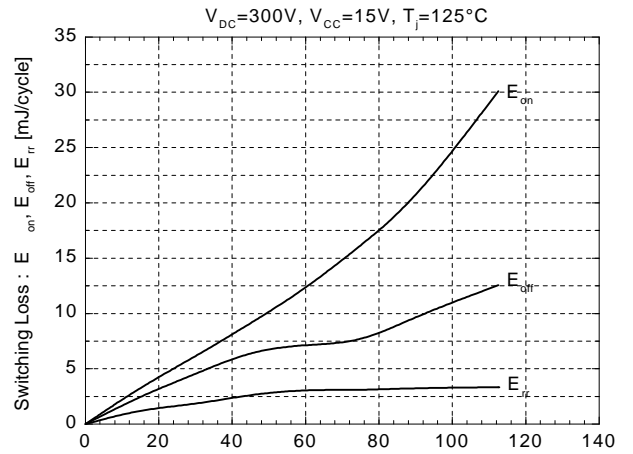

■ Inverter

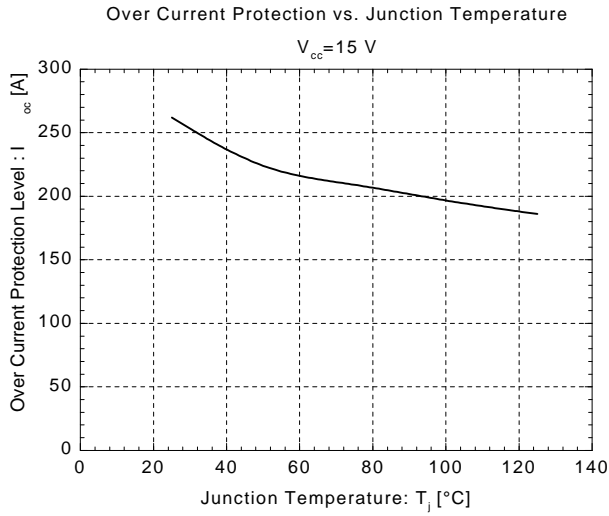

■ Outline Drawing

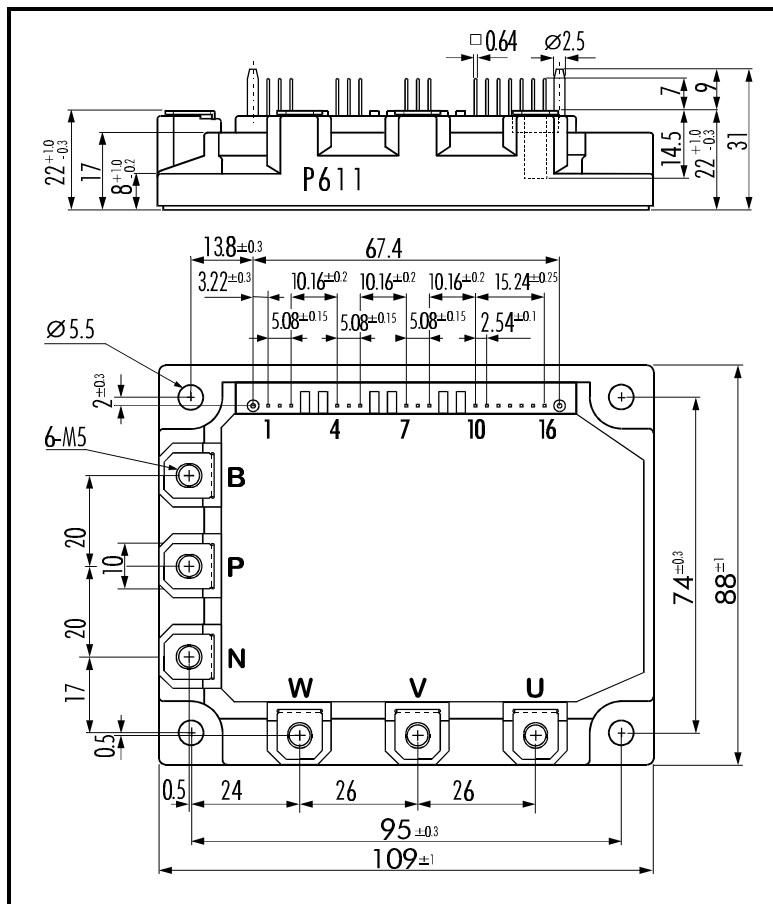

Weight: 440g