

DATA SHEET

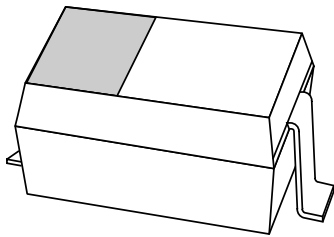

**PMEG2005AEA; PMEG3005AEA;
PMEG4005AEA**

Very low V_F MEGA Schottky barrier
rectifiers

Product specification

2003 Aug 20

Very low V_F MEGA Schottky barrier rectifiers

PMEG2005AEA; PMEG3005AEA; PMEG4005AEA

FEATURES

- Very low forward voltage
- High surge current
- Very small plastic SMD package.

APPLICATIONS

- Low voltage rectification
- High efficiency DC/DC conversion
- Voltage clamping
- Inverse polarity protection
- Low power consumption applications.

DESCRIPTION

Planar Maximum Efficiency General Application (MEGA) Schottky barrier rectifier with an integrated guard ring for stress protection, encapsulated in a SOD323 (SC-76) very small SMD plastic package.

QUICK REFERENCE DATA

SYMBOL	PARAMETER	MAX.	UNIT
I_F	forward current	0.5	A
V_R	reverse voltage		
	PMEG2005AEA	20	V
	PMEG3005AEA	30	V
	PMEG4005AEA	40	V

PINNING

PIN	DESCRIPTION
1	cathode
2	anode

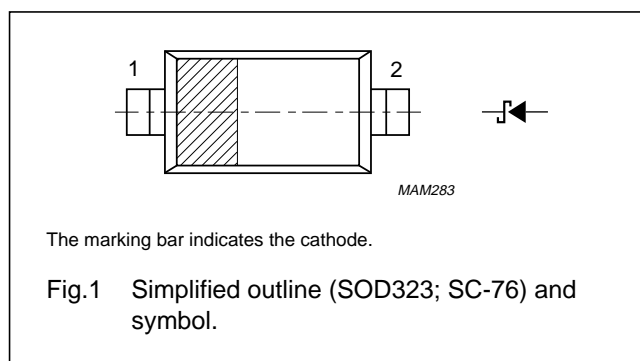

MARKING

TYPE NUMBER	MARKING CODE
PMEG2005AEA	E5
PMEG3005AEA	E4
PMEG4005AEA	E3

RELATED PRODUCTS

TYPE NUMBER	DESCRIPTION	FEATURE
PMEGxx05AEV	0.5 A; 20/30/40 V very low V_F MEGA Schottky rectifier	SOT666 package
PMEG2005EB	0.5 A; 20 V very low V_F MEGA Schottky rectifier	smaller SOD523 (SC-79) package
PMEG2010EA	1 A; 20 V very low V_F MEGA Schottky rectifier	higher forward current

Very low V_F MEGA
Schottky barrier rectifiers

PMEG2005AEA; PMEG3005AEA;
PMEG4005AEA

LIMITING VALUES

In accordance with the Absolute Maximum Rating System (IEC 60134).

SYMBOL	PARAMETER	CONDITIONS	MIN.	MAX.	UNIT
V_R	continuous reverse voltage				
	PMEG2005AEA		–	20	V
	PMEG3005AEA		–	30	V
	PMEG4005AEA		–	40	V
I_F	continuous forward current	note 1	–	0.5	A
I_{FRM}	repetitive peak forward current	$t_p \leq 1$ ms; $\delta \leq 0.5$	–	3.5	A
I_{FSM}	non-repetitive peak forward current	$t_p = 8$ ms; square wave	–	10	A
T_j	junction temperature	note 2	–	150	°C
T_{amb}	operating ambient temperature	note 2	–65	+150	°C
T_{stg}	storage temperature		–65	+150	°C

Notes

1. Refer to SOD323 (SC-76) standard mounting conditions.
2. For Schottky barrier diodes thermal runaway has to be considered, as in some applications the reverse power losses P_R are a significant part of the total power losses. Nomograms for determination of the reverse power losses P_R and $I_{F(AV)}$ rating will be available on request.

THERMAL CHARACTERISTICS

SYMBOL	PARAMETER	CONDITIONS	VALUE	UNIT
$R_{th\ j-a}$	thermal resistance from junction to ambient	in free air; notes 1 and 2	450	K/W
		in free air; notes 2 and 3	210	K/W
$R_{th\ j-s}$	thermal resistance from junction to soldering point	note 4	90	K/W

Notes

1. Refer to SOD323 (SC-76) standard mounting conditions.
2. For Schottky barrier diodes thermal runaway has to be considered, as in some applications the reverse power losses P_R are a significant part of the total power losses. Nomograms for determination of the reverse power losses P_R and $I_{F(AV)}$ rating will be available on request.
3. Device mounted on an FR4 printed-circuit board with copper clad 10 × 10 mm.
4. Solder point of cathode tab.

Very low V_F MEGA
Schottky barrier rectifiers

PMEG2005AEA; PMEG3005AEA;
PMEG4005AEA

ELECTRICAL CHARACTERISTICS

$T_{amb} = 25\text{ }^{\circ}\text{C}$ unless otherwise specified.

SYMBOL	PARAMETER	CONDITIONS	PMEG2005AEA		PMEG3005AEA		PMEG4005AEA		UNIT
			TYP.	MAX.	TYP.	MAX.	TYP.	MAX.	
V_F	forward voltage	$I_F = 0.1\text{ mA}$	90	130	90	130	95	130	mV
		$I_F = 1\text{ mA}$	150	190	150	200	155	210	mV
		$I_F = 10\text{ mA}$	210	240	215	250	220	270	mV
		$I_F = 100\text{ mA}$	280	330	285	340	295	350	mV
		$I_F = 500\text{ mA}$	355	390	380	430	420	470	mV
I_R	continuous reverse current	$V_R = 10\text{ V}$; note 1	15	40	12	30	7	20	μA
		$V_R = 20\text{ V}$; note 1	40	200	–	–	–	–	μA
		$V_R = 30\text{ V}$; note 1	–	–	40	150	–	–	μA
		$V_R = 40\text{ V}$; note 1	–	–	–	–	30	100	μA
C_d	diode capacitance	$V_R = 1\text{ V}$; $f = 1\text{ MHz}$	66	80	55	70	43	50	pF

Note

1. Pulse test: $t_p \leq 300\text{ }\mu\text{s}$; $\delta \leq 0.02$.

Very low V_F MEGA
Schottky barrier rectifiers

PMEG2005AEA; PMEG3005AEA;
PMEG4005AEA

GRAPHICAL DATA

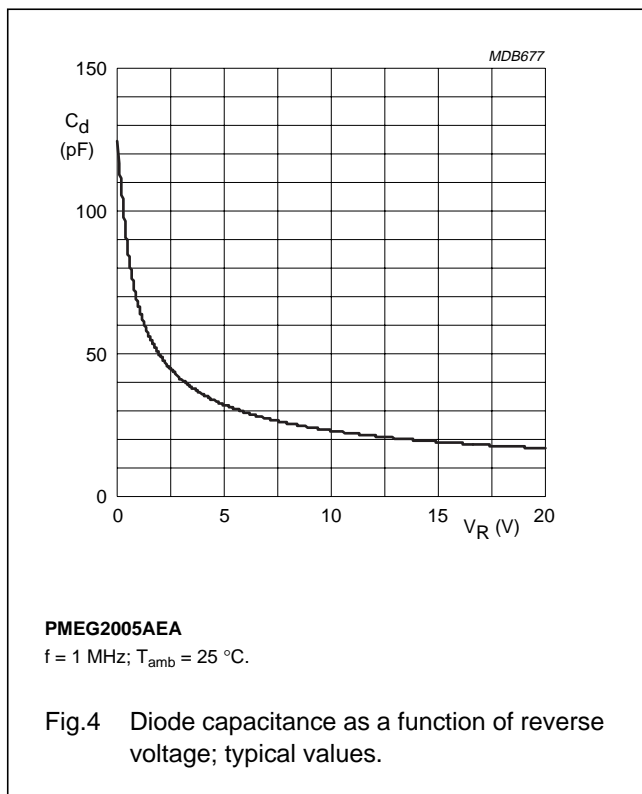
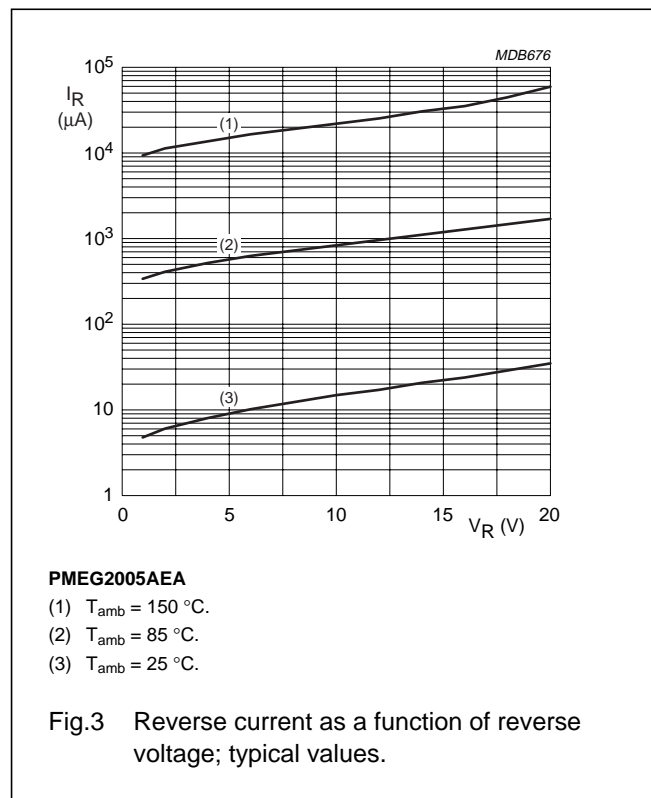
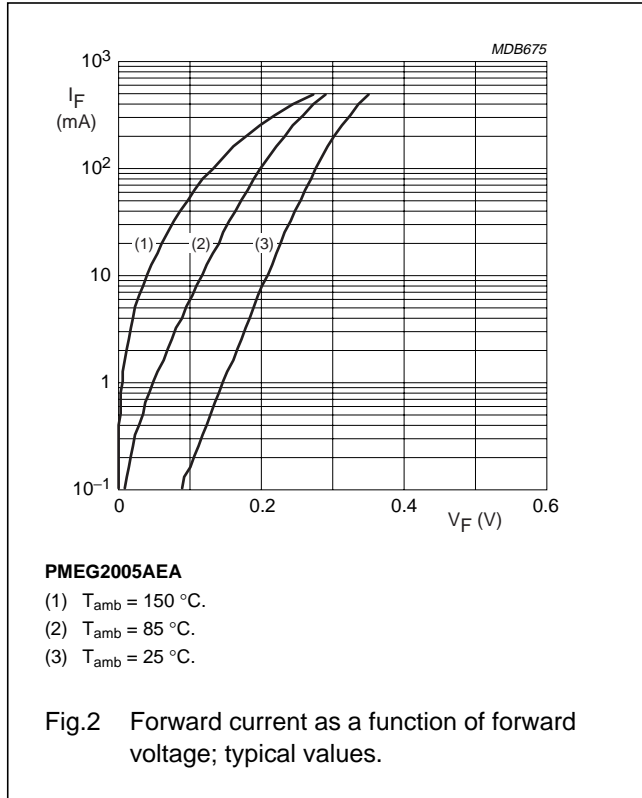

Very low V_F MEGA
Schottky barrier rectifiers

PMEG2005AEA; PMEG3005AEA;
PMEG4005AEA

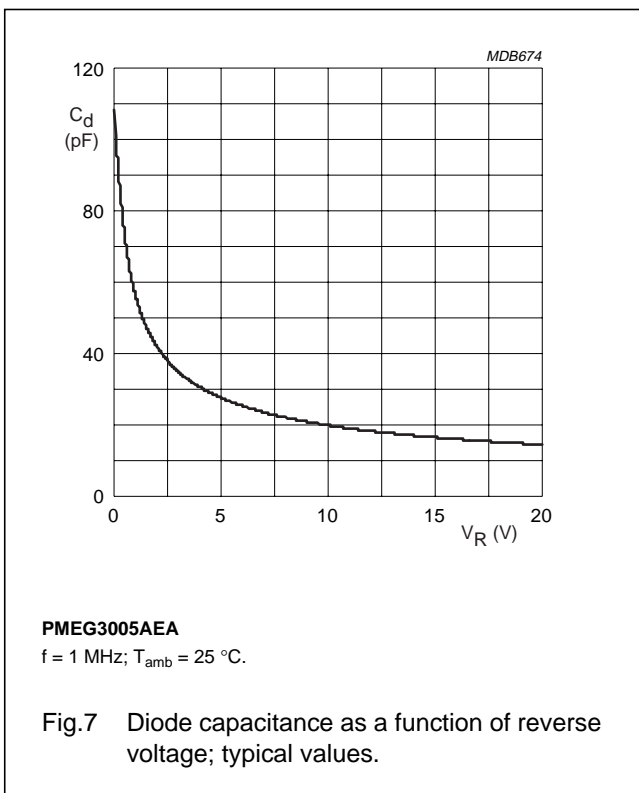
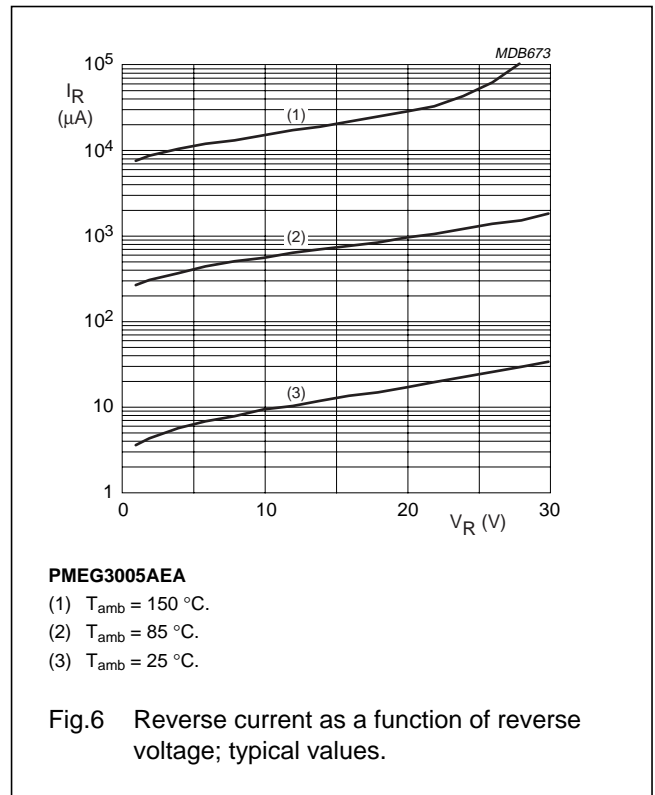
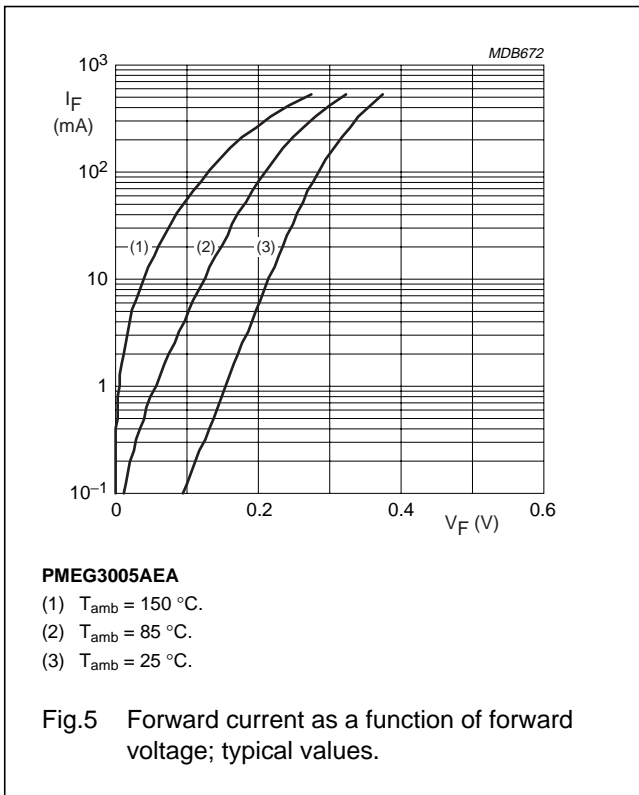

Very low V_F MEGA
Schottky barrier rectifiers

PMEG2005AEA; PMEG3005AEA;
PMEG4005AEA

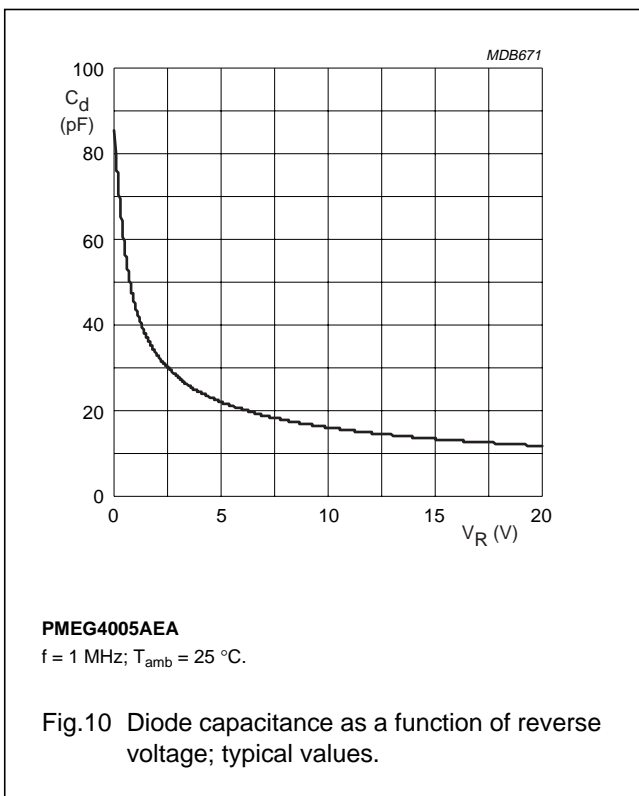
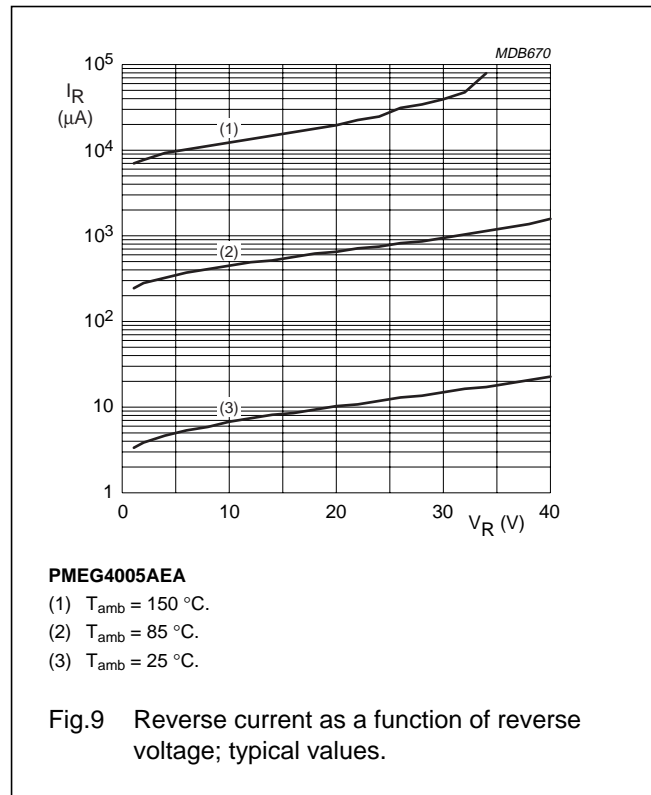
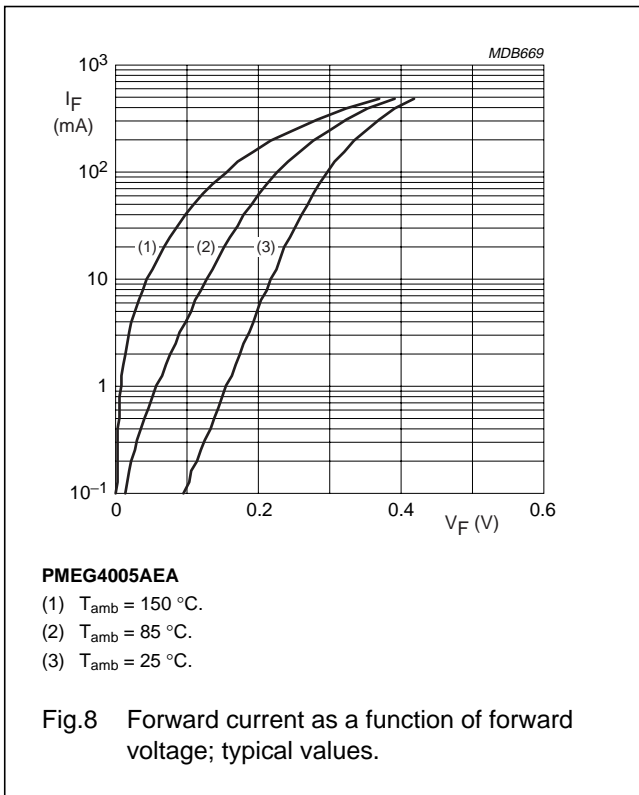

Very low V_F MEGA
Schottky barrier rectifiers

PMEG2005AEA; PMEG3005AEA;
PMEG4005AEA

PACKAGE OUTLINE

Plastic surface mounted package; 2 leads

SOD323

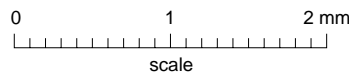
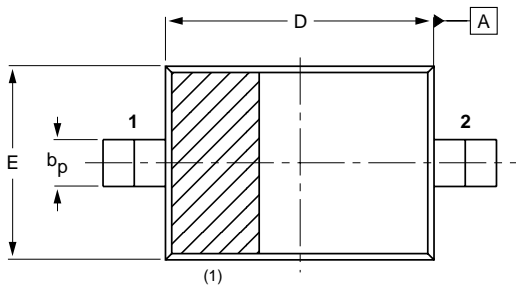
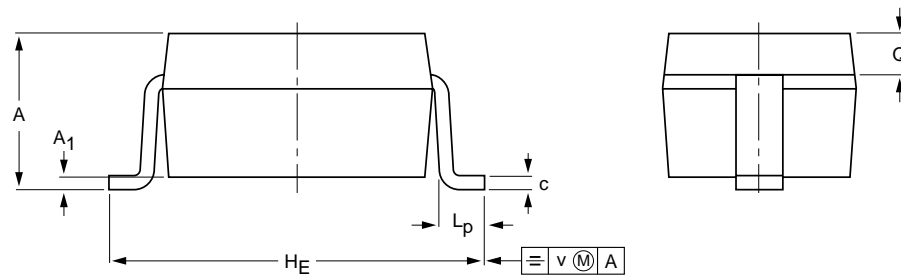

DIMENSIONS (mm are the original dimensions)

UNIT	A	A ₁ max.	b _p	c	D	E	H _E	L _p	Q	v
mm	1.1 0.8	+0.05 -0.05	0.40 0.25	0.25 0.10	1.8 1.6	1.35 1.15	2.7 2.3	0.45 0.15	0.25 0.15	0.2

Note

1. The marking bar indicates the cathode.

OUTLINE VERSION	REFERENCES			EUROPEAN PROJECTION	ISSUE DATE
	IEC	JEDEC	EIAJ		
SOD323			SC-76		98-09-14 99-09-13

Very low V_F MEGA
Schottky barrier rectifiers

PMEG2005AEA; PMEG3005AEA;
PMEG4005AEA

DATA SHEET STATUS

LEVEL	DATA SHEET STATUS ⁽¹⁾	PRODUCT STATUS ⁽²⁾⁽³⁾	DEFINITION
I	Objective data	Development	This data sheet contains data from the objective specification for product development. Philips Semiconductors reserves the right to change the specification in any manner without notice.
II	Preliminary data	Qualification	This data sheet contains data from the preliminary specification. Supplementary data will be published at a later date. Philips Semiconductors reserves the right to change the specification without notice, in order to improve the design and supply the best possible product.
III	Product data	Production	This data sheet contains data from the product specification. Philips Semiconductors reserves the right to make changes at any time in order to improve the design, manufacturing and supply. Relevant changes will be communicated via a Customer Product/Process Change Notification (CPCN).

Notes

1. Please consult the most recently issued data sheet before initiating or completing a design.
2. The product status of the device(s) described in this data sheet may have changed since this data sheet was published. The latest information is available on the Internet at URL <http://www.semiconductors.philips.com>.
3. For data sheets describing multiple type numbers, the highest-level product status determines the data sheet status.

DEFINITIONS

Short-form specification — The data in a short-form specification is extracted from a full data sheet with the same type number and title. For detailed information see the relevant data sheet or data handbook.

Limiting values definition — Limiting values given are in accordance with the Absolute Maximum Rating System (IEC 60134). Stress above one or more of the limiting values may cause permanent damage to the device. These are stress ratings only and operation of the device at these or at any other conditions above those given in the Characteristics sections of the specification is not implied. Exposure to limiting values for extended periods may affect device reliability.

Application information — Applications that are described herein for any of these products are for illustrative purposes only. Philips Semiconductors make no representation or warranty that such applications will be suitable for the specified use without further testing or modification.

DISCLAIMERS

Life support applications — These products are not designed for use in life support appliances, devices, or systems where malfunction of these products can reasonably be expected to result in personal injury. Philips Semiconductors customers using or selling these products for use in such applications do so at their own risk and agree to fully indemnify Philips Semiconductors for any damages resulting from such application.

Right to make changes — Philips Semiconductors reserves the right to make changes in the products - including circuits, standard cells, and/or software - described or contained herein in order to improve design and/or performance. When the product is in full production (status 'Production'), relevant changes will be communicated via a Customer Product/Process Change Notification (CPCN). Philips Semiconductors assumes no responsibility or liability for the use of any of these products, conveys no licence or title under any patent, copyright, or mask work right to these products, and makes no representations or warranties that these products are free from patent, copyright, or mask work right infringement, unless otherwise specified.

Philips Semiconductors – a worldwide company

Contact information

For additional information please visit <http://www.semiconductors.philips.com>. Fax: +31 40 27 24825

For sales offices addresses send e-mail to: sales.addresses@www.semiconductors.philips.com.

© Koninklijke Philips Electronics N.V. 2003

SCA75

All rights are reserved. Reproduction in whole or in part is prohibited without the prior written consent of the copyright owner.

The information presented in this document does not form part of any quotation or contract, is believed to be accurate and reliable and may be changed without notice. No liability will be accepted by the publisher for any consequence of its use. Publication thereof does not convey nor imply any license under patent- or other industrial or intellectual property rights.

Printed in The Netherlands

613514/01/pp10

Date of release: 2003 Aug 20

Document order number: 9397 750 11615

Let's make things better.

**Philips
Semiconductors**



PHILIPS