

# PTF 10007

## 35 Watts, 1.0 GHz

### GOLDMOS® Field Effect Transistor

#### Description

The PTF 10007 is a 35 Watt GOLDMOS FET intended for large signal amplifier applications to 1.0 GHz. It operates at 55% efficiency and 13.5 dB of gain. Nitride surface passivation and gold metallization ensure excellent device lifetime and reliability.

- Performance at 960 MHz, 28 Volts
  - Output Power = 35 Watts
  - Power Gain = 13.5 dB Typ
  - Efficiency = 55% Typ
- Full Gold Metallization
- Silicon Nitride Passivated
- Back Side Common Source
- 100% lot traceability
- Available in Package 20235 as PTF 10052

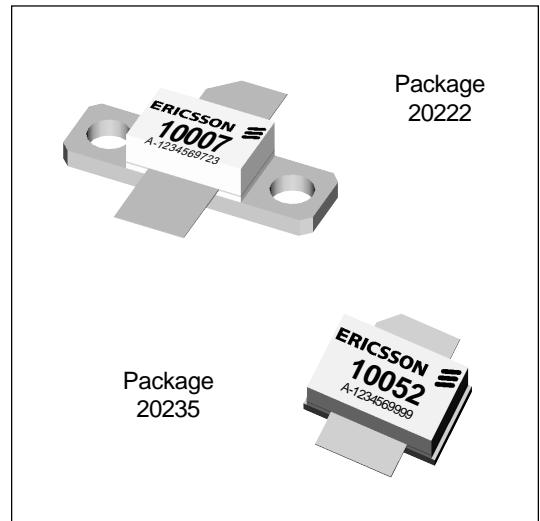
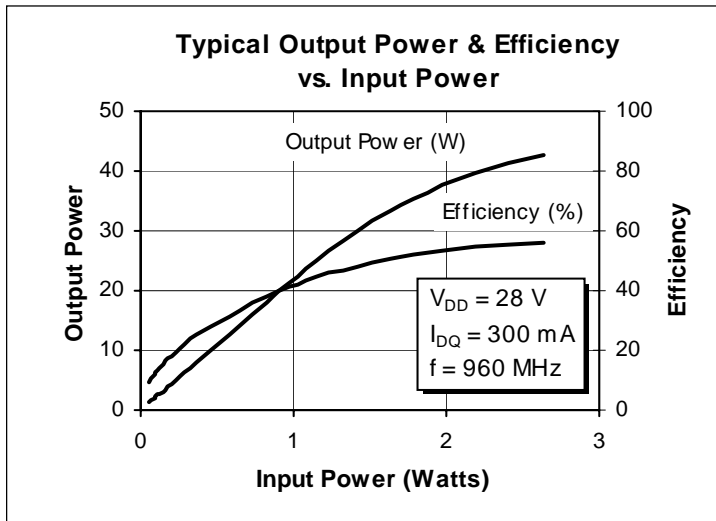

#### Maximum Ratings

Parameter	Symbol	Value	Unit
Drain-Source Voltage	$V_{DSS}$	60	Vdc
Gate-Source Voltage	$V_{GS}$	$\pm 20$	Vdc
Operating Junction Temperature	$T_J$	200	$^{\circ}\text{C}$
Total Device Dissipation at $T_{flange} = 25^{\circ}\text{C}$ Above $25^{\circ}\text{C}$ derate by	$P_D$	120 0.7	Watts $\text{W}/^{\circ}\text{C}$
Storage Temperature Range	$T_{STG}$	-40 to +150	$^{\circ}\text{C}$
Thermal Resistance ( $T_{flange} = 70^{\circ}\text{C}$ )	$R_{\theta JC}$	1.4	$^{\circ}\text{C}/\text{W}$

## Electrical Characteristics (100% Tested)

Characteristic	Conditions	Symbol	Min	Typ	Max	Units
Drain-Source Breakdown Voltage	$V_{GS} = 0\text{ V}, I_D = 5\text{ mA}$	$V_{(BR)DSS}$	65	70	—	Volts
Drain-Source Leakage Current	$V_{DS} = 28\text{ V}, V_{GS} = 0\text{ V}$	$I_{DSS}$	—	—	1.0	mA
Gate Threshold Voltage	$V_{DS} = 10\text{ V}, I_D = 75\text{ mA}$	$V_{GS(th)}$	3.0	—	5.0	Volts
Forward Transconductance	$V_{DS} = 10\text{ V}, I_D = 3\text{ A}$	$g_{fs}$	—	2.8	—	Siemens

## RF Specifications (100% Tested)

Characteristic	Symbol	Min	Typ	Max	Units
<b>Gain</b> ( $V_{DD} = 28\text{ V}, P_{OUT} = 35\text{ W}, I_{DQ} = 300\text{ mA}, f = 960\text{ MHz}$ )	$G_{ps}$	12.0	13.5	—	dB
<b>Power Output at 1 dB Compression</b> ( $V_{DD} = 28\text{ V}, I_{DQ} = 300\text{ mA}, f = 960\text{ MHz}$ )	P-1dB	35	—	—	Watts
<b>Drain Efficiency</b> ( $V_{DD} = 28\text{ V}, P_{OUT} = 35\text{ W}, I_{DQ} = 300\text{ mA}, f = 960\text{ MHz}$ )	$\eta$	50	55	—	%
<b>Load Mismatch Tolerance</b> ( $V_{DD} = 28\text{ V}, P_{OUT} = 35\text{ W}, I_{DQ} = 300\text{ mA}, f = 960\text{ MHz}$ — all phase angles at frequency of test)	$\Psi$	—	—	10:1	—

## Typical Performance

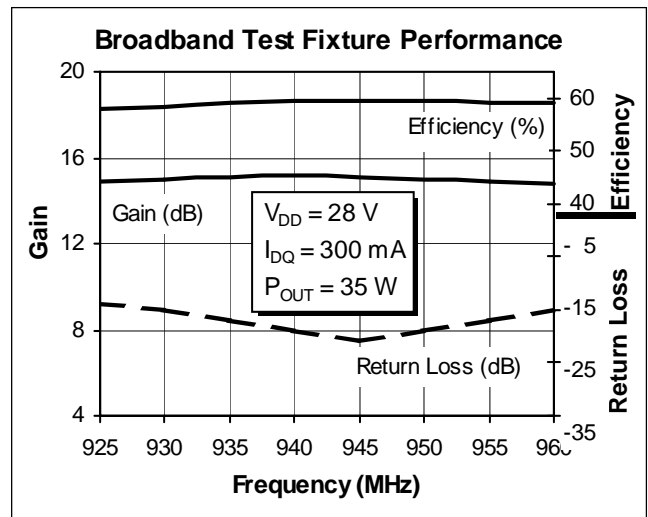
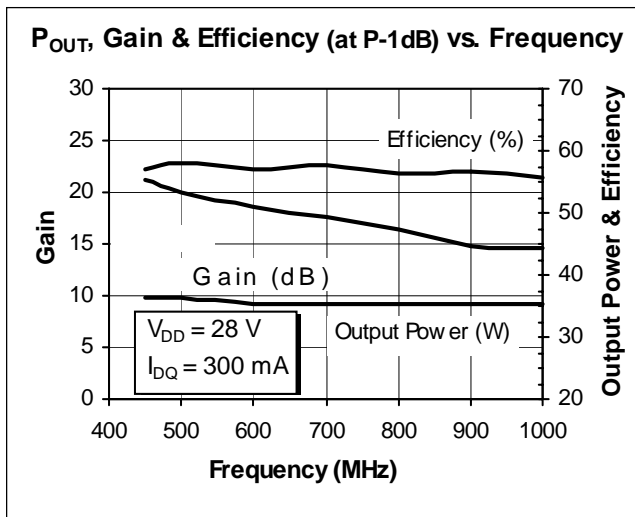

**Typical Performance**

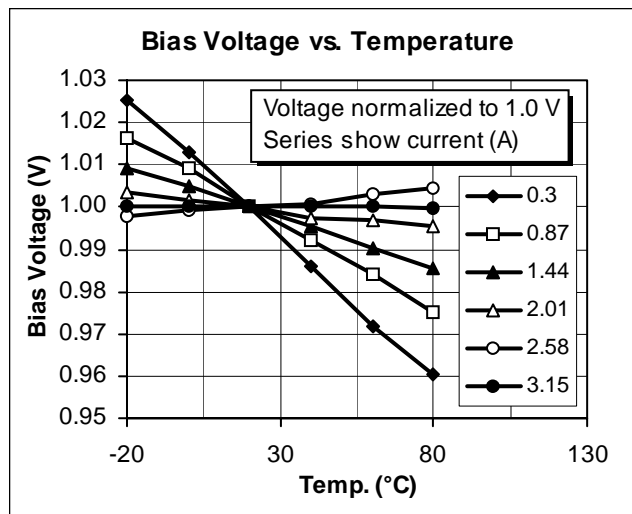
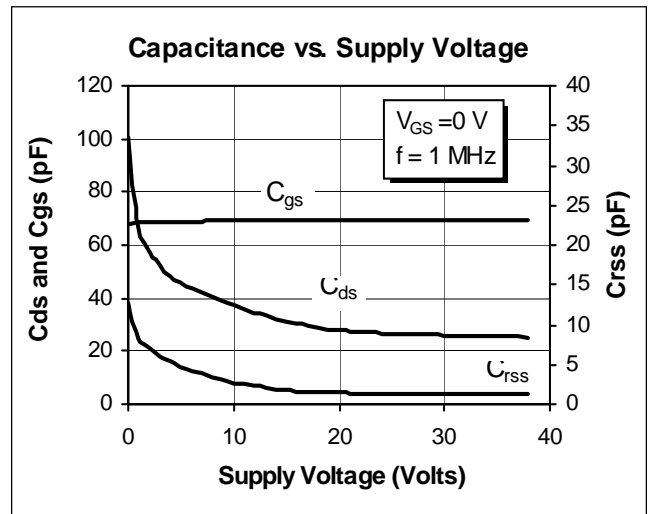
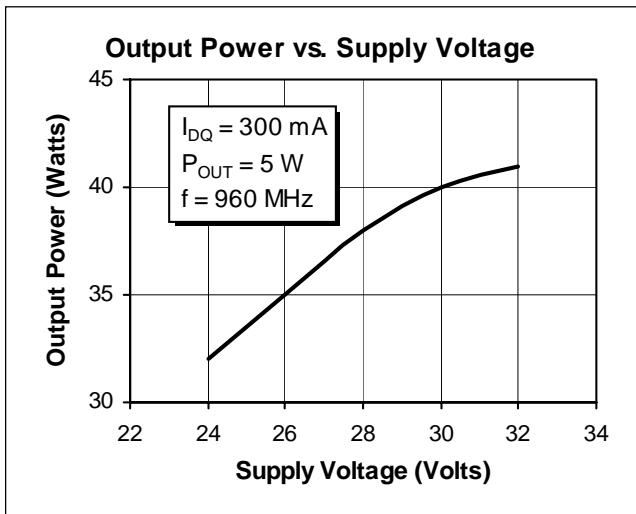
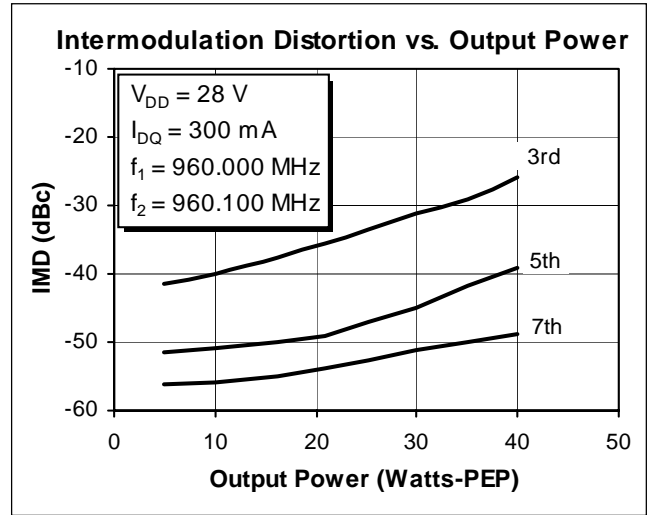
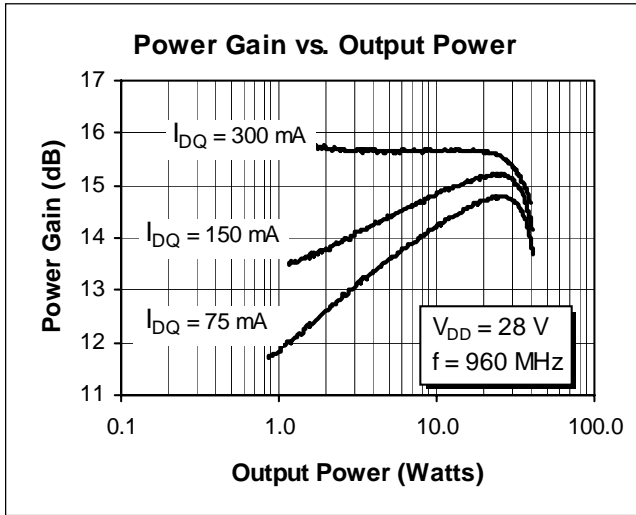

## Impedance Data (shown for fixed-tuned broadband circuit)

$V_{DD} = 28\text{ V}$ ,  $P_{OUT} = 35\text{ W}$ ,  $I_{DQ} = 300\text{ mA}$

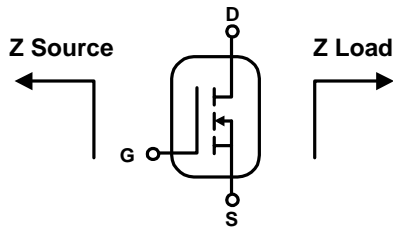

Frequency MHz	Z Source $\Omega$		Z Load $\Omega$	
	R	jX	R	jX
850	1.48	-2.80	2.60	1.55
900	1.45	-1.65	2.60	2.30
950	1.35	-0.30	2.68	3.40
1000	1.10	0.88	2.70	4.15

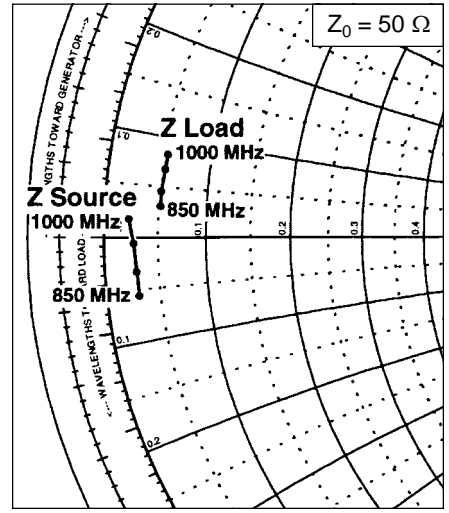

## Typical Scattering Parameters

( $V_{DS} = 28\text{ V}$ ,  $I_D = 2.0\text{ A}$ )

f (MHz)	S11		S21		S12		S22	
	Mag	Ang	Mag	Ang	Mag	Ang	Mag	Ang
400	0.948	-167	3.668	33	0.006	-37	0.858	-149
420	0.951	-168	3.403	32	0.005	-37	0.866	-150
440	0.955	-168	3.161	30	0.005	-37	0.877	-151
460	0.956	-168	2.943	29	0.005	-36	0.886	-152
480	0.957	-168	2.745	28	0.004	-38	0.892	-152
500	0.959	-168	2.575	27	0.004	-35	0.898	-153
520	0.960	-169	2.421	26	0.004	-34	0.903	-153
540	0.962	-169	2.282	25	0.004	-30	0.907	-154
560	0.963	-169	2.151	24	0.003	-29	0.911	-155
580	0.964	-169	2.024	22	0.003	-28	0.913	-155
600	0.964	-169	1.907	22	0.003	-23	0.919	-156
620	0.965	-169	1.806	21	0.002	-20	0.925	-156
640	0.967	-169	1.72	21	0.002	-13	0.929	-156
660	0.966	-170	1.636	20	0.002	-6	0.929	-157
680	0.967	-170	1.558	19	0.002	3	0.929	-157
700	0.967	-170	1.483	18	0.002	8	0.928	-157
720	0.968	-170	1.413	18	0.002	21	0.930	-158
740	0.968	-170	1.345	17	0.002	25	0.932	-158
760	0.967	-170	1.281	17	0.002	33	0.935	-159
780	0.966	-170	1.228	17	0.002	44	0.937	-159
800	0.967	-170	1.179	16	0.002	51	0.938	-159
820	0.968	-170	1.134	16	0.002	55	0.939	-159
840	0.967	-170	1.088	15	0.002	59	0.938	-160
860	0.967	-170	1.039	15	0.003	67	0.938	-160
880	0.967	-170	0.993	14	0.003	68	0.938	-160
900	0.966	-170	0.957	14	0.003	73	0.941	-161
920	0.966	-171	0.922	14	0.003	75	0.943	-161
940	0.966	-171	0.890	14	0.003	79	0.941	-161
960	0.966	-171	0.859	13	0.004	81	0.942	-161
980	0.966	-171	0.827	13	0.004	83	0.943	-161
1000	0.965	-171	0.794	12	0.004	86	0.942	-162

**Test Circuit**

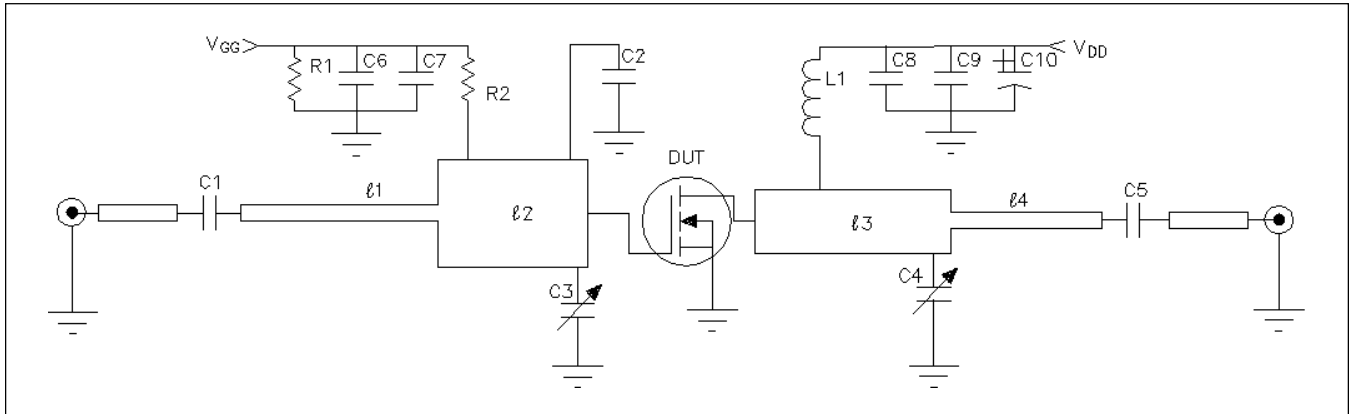

*Test Circuit Schematic for  $f = 960$  MHz*

DUT	PTF 10007	
C1, C5	39 pF, Capacitor ATC 100 B	
C2	7.5 pF, Capacitor ATC 100 B	
C3	0.6–6.0 pF, Trimmer Capacitor, Johanson, 5701-PC	
C4	0.35–3.5 pF, Trimmer Capacitor, Johanson, 5801-PC	
C6, C8	51 pF, Capacitor ATC 100 B	
C7, C9	0.1 $\mu$ F, 50 V, Capacitor, Digi-Key P4917-ND	
C10	100 $\mu$ F, 50 V, Electrolytic Capacitor, Digi-Key P5276	
L1	4 Turn, #20 AWG, .120" I.D.	
R1	1 K, 1/4 W Resistor	
R2	10 K, 1/4 W Resistor	
l1, l4	Microstrip 50 $\Omega$	
l2	0.185 $\lambda$ 960 MHz	Microstrip 5.70 $\Omega$
l3	0.240 $\lambda$ 960 MHz	Microstrip 9.30 $\Omega$
Circuit Board	.028" Dielectric Thickness, $\epsilon_r = 4.0$ , AlliedSignal, G200, 2 oz. copper	

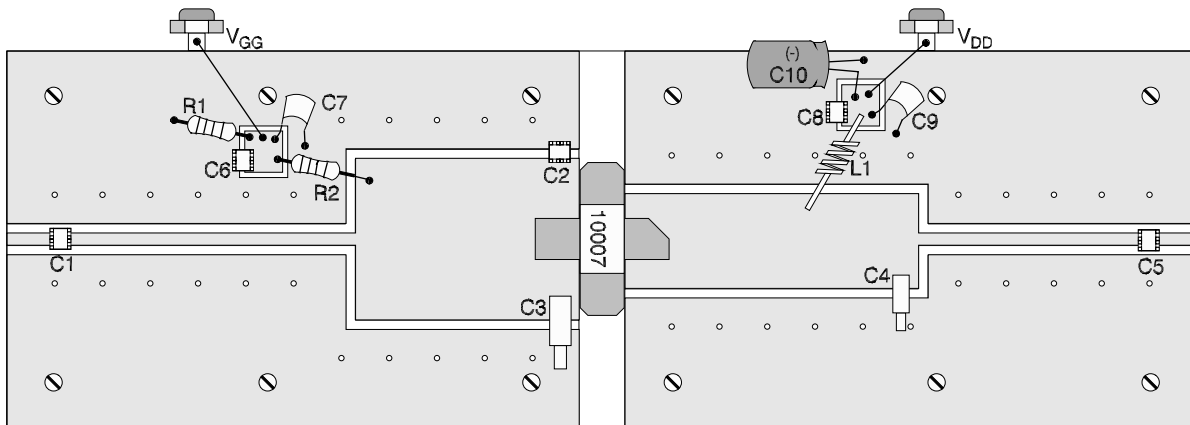

*Parts Layout (not to scale)*

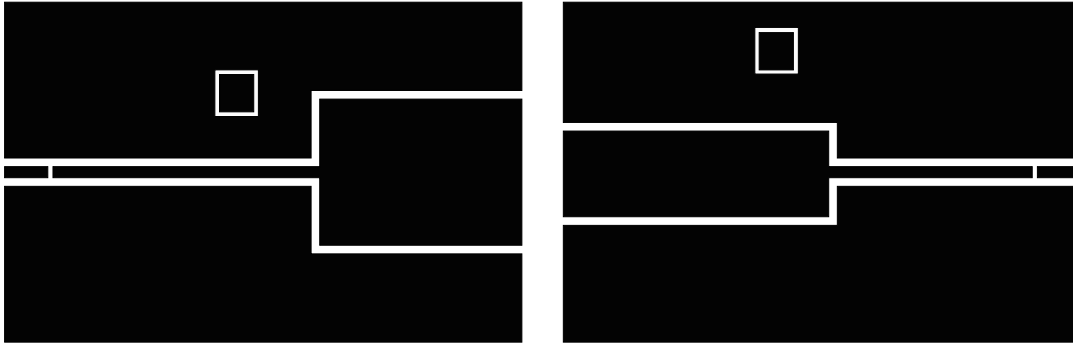

Artwork (not to scale)

Package Mechanical Specifications

