



SPECIAL ENVIRONMENT 80960CA-25, -16 32-BIT HIGH-PERFORMANCE EMBEDDED PROCESSOR

- *Two Instructions/Clock Sustained Execution*
- *Four 59 Mbytes/s DMA Channels with Data Chaining*
- *Demultiplexed 32-bit Burst Bus with Pipelining*

- **32-bit Parallel Architecture**
 - Two Instructions/clock Execution
 - Load/Store Architecture
 - Sixteen 32-bit Global Registers
 - Sixteen 32-bit Local Registers
 - Manipulates 64-bit Bit Fields
 - 11 Addressing Modes
 - Full Parallel Fault Model
 - Supervisor Protection Model
 - **Fast Procedure Call/Return Model**
 - Full Procedure Call in 4 Clocks
 - **On-Chip Register Cache**
 - Caches Registers on Call/Ret
 - Minimum of 6 Frames Provided
 - Up to 15 Programmable Frames
 - **On-Chip instruction Cache**
 - 1 Kbyte Two-Way Set Associative
 - 128-bit Path to instruction Sequencer
 - Cache-Lock Modes
 - Cache-Off Mode
 - **High Bandwidth On-Chip Data RAM**
 - 1 Kbyte On-Chip Data RAM
 - Sustains 128 bits per Clock Access
 - **Four On-Chip DMA Channels**
 - 59 Mbytes/s Fly-by Transfers
 - 32 Mbytes/s Two-Cycle Transfers
 - Data Chaining
 - Data Packing/Unpacking
 - Programmable Priority Method
 - **32-Bit Demultiplexed Burst Bus**
 - 128-bit internal Data Paths to *and* from Registers
 - Burst Bus for DRAM Interfacing
 - Address Pipelining Option
 - Fully Programmable Wait States
 - Supports 8-, 16- or 32-bit Bus Widths
 - Supports Unaligned Accesses
 - Supervisor Protection Pin
 - **Selectable Big or Little Endian Byte Ordering**
 - **High-Speed Interrupt Controller**
 - Up to 248 External interrupts
 - 32 Fully Programmable Priorities
 - Multi-mode 8-bit Interrupt Port
 - Four internal DMA Interrupts
 - Separate, Non-maskable interrupt Pin
 - Context Switch in 750 ns Typical
 - **Product Grades Available**
 - SE3: -40°C to +110°C
-

SPECIAL ENVIRONMENT 80960CA-25, -16

32-BIT HIGH-PERFORMANCE EMBEDDED PROCESSOR

CONTENTS	PAGE
1.0 PURPOSE	5
2.0 80960CA OVERVIEW	5
2.1 The C-Series Core	6
2.2 Pipelined, Burst Bus	6
2.3 Flexible DMA Controller	6
2.4 Priority Interrupt Controller	6
2.5 Instruction Set Summary	7
3.0 PACKAGE INFORMATION	8
3.1 Package Introduction	8
3.2 Pin Descriptions	8
3.3 80960CA Mechanical Data	15
3.3.1 80960CA PGA Pinout	15
3.4 Package Thermal Specifications	19
3.5 Stepping Register Information	21
3.6 Suggested Sources for 80960CA Accessories	21
4.0 ELECTRICAL SPECIFICATIONS	22
4.1 Absolute Maximum Ratings	22
4.2 Operating Conditions	22
4.3 Recommended Connections	22
4.4 DC Specifications	23
4.5 AC Specifications	24
4.5.1 AC Test Conditions	28
4.5.2 AC Timing Waveforms	28
4.5.3 Derating Curves	32
5.0 RESET, BACKOFF AND HOLD ACKNOWLEDGE	34
6.0 BUS WAVEFORMS	35
7.0 REVISION HISTORY	62

CONTENTS

PAGE

LIST OF FIGURES

Figure 1	80960CA Block Diagram	5
Figure 2	80960CA PGA Pinout—View from Top (Pins Facing Down)	17
Figure 3	80960CA PGA Pinout—View from Bottom (Pins Facing Up)	18
Figure 4	Measuring 80960CA PGA Case Temperature	19
Figure 5	Register g0	21
Figure 6	AC Test Load	28
Figure 7	Input and Output Clocks Waveform	28
Figure 8	CLKIN Waveform	28
Figure 9	Output Delay and Float Waveform	29
Figure 10	Input Setup and Hold Waveform	29
Figure 11	$\overline{\text{NMI}}$, $\overline{\text{XINT7:0}}$ Input Setup and Hold Waveform	30
Figure 12	Hold Acknowledge Timings	30
Figure 13	Bus Backoff ($\overline{\text{BOFF}}$) Timings	31
Figure 14	Relative Timings Waveforms	32
Figure 15	Output Delay or Hold vs Load Capacitance	32
Figure 16	Rise and Fall Time Derating at Highest Operating Temperature and Minimum V_{CC}	33
Figure 17	I_{CC} vs Frequency and Temperature	33
Figure 18	Cold Reset Waveform	35
Figure 19	Warm Reset Waveform	36
Figure 20	Entering the ONCE State	37
Figure 21	Clock Synchronization in the 2-x Clock Mode	38
Figure 22	Clock Synchronization in the 1-x Clock Mode	38
Figure 23	Non-Burst, Non-Pipelined Requests without Wait States	39
Figure 24	Non-Burst, Non-Pipelined Read Request with Wait States	40
Figure 25	Non-Burst, Non-Pipelined Write Request with Wait States	41
Figure 26	Burst, Non-Pipelined Read Request without Wait States, 32-Bit Bus	42
Figure 27	Burst, Non-Pipelined Read Request with Wait States, 32-Bit Bus	43
Figure 28	Burst, Non-Pipelined Write Request without Wait States, 32-Bit Bus	44
Figure 29	Burst, Non-Pipelined Write Request with Wait States, 32-Bit Bus	45
Figure 30	Burst, Non-Pipelined Read Request with Wait States, 16-Bit Bus	46
Figure 31	Burst, Non-Pipelined Read Request with Wait States, 8-Bit Bus	47
Figure 32	Non-Burst, Pipelined Read Request without Wait States, 32-Bit Bus	48
Figure 33	Non-Burst, Pipelined Read Request with Wait States, 32-Bit Bus	49
Figure 34	Burst, Pipelined Read Request without Wait States, 32-Bit Bus	50
Figure 35	Burst, Pipelined Read Request with Wait States, 32-Bit Bus	51
Figure 36	Burst, Pipelined Read Request with Wait States, 16-Bit Bus	52
Figure 37	Burst, Pipelined Read Request with Wait States, 8-Bit Bus	53

CONTENTS

PAGE

LIST OF FIGURES (Continued)

Figure 38	Using External $\overline{\text{READY}}$	54
Figure 39	Terminating a Burst with $\overline{\text{BTERM}}$	55
Figure 40	$\overline{\text{BOFF}}$ Functional Timing	56
Figure 41	HOLD Functional Timing	57
Figure 42	$\overline{\text{DREQ}}$ and $\overline{\text{DACK}}$ Functional Timing	58
Figure 43	$\overline{\text{EOP}}$ Functional Timing	58
Figure 44	Terminal Count Functional Timing	59
Figure 45	$\overline{\text{FAIL}}$ Functional Timing	59
Figure 46	A Summary of Aligned and Unaligned Transfers for Little Endian Regions	60
Figure 47	A Summary of Aligned and Unaligned Transfers for Little Endian Regions (Continued)	61
Figure 48	Idle Bus Operation	62

LIST OF TABLES

Table 1	80960CA Instruction Set	7
Table 2	Pin Description Nomenclature	8
Table 3	80960CA Pin Description—External Bus Signals	9
Table 4	80960CA Pin Description—Processor Control Signals	12
Table 5	80960CA Pin Description—DMA and Interrupt Unit Control Signals	14
Table 6	80960CA PGA Pinout—In Signal Order	15
Table 7	80960CA PGA Pinout—In Pin Order	16
Table 8	Maximum T_A at Various Airflows in °C	19
Table 9	80960CA PGA Package Thermal Characteristics	20
Table 10	Die Stepping Cross Reference	21
Table 11	Operating Conditions (80960CA-25, -16)	22
Table 12	DC Characteristics	23
Table 13	80960CA AC Characteristics (25 MHz)	24
Table 14	80960CA AC Characteristics (16 MHz)	26
Table 15	Reset Conditions	34
Table 16	Hold Acknowledge and Backoff Conditions	34

1.0 PURPOSE

This document provides electrical characteristics for the 25 and 16 MHz versions of the 80960CA. For a detailed description of any 80960CA functional topic—other than parametric performance—consult the *80960CA Product Overview* (Order No. 270669) or the *i960® CA Microprocessor User's Manual* (Order No. 270710). To obtain data sheet updates and errata, please call Intel's FaxBACK® data-on-demand system (1-800-628-2283 or 916-356-3105). Other information can be obtained from Intel's technical BBS (916-356-3600).

2.0 80960CA OVERVIEW

The 80960CA is the second-generation member of the 80960 family of embedded processors. The 80960CA is object code compatible with the 32-bit 80960 Core Architecture while including Special Function Register extensions to control on-chip peripherals and instruction set extensions to shift 64-bit operands and configure on-chip hardware. Multiple 128-bit internal buses, on-chip instruction caching and a sophisticated instruction scheduler allow the processor to sustain execution of two instructions every clock and peak at execution of three instructions per clock.

A 32-bit demultiplexed and pipelined burst bus provides a 132 Mbyte/s bandwidth to a system's high-speed external memory sub-system. In addition, the 80960CA's on-chip caching of instructions, procedure context and critical program data substantially decouple system performance from the wait states associated with accesses to the system's slower, cost sensitive, main memory subsystem.

The 80960CA bus controller integrates full wait state and bus width control for highest system performance with minimal system design complexity. Unaligned access and Big Endian byte order support reduces the cost of porting existing applications to the 80960CA.

The processor also integrates four complete data-chaining DMA channels and a high-speed interrupt controller on-chip. DMA channels perform: single-cycle or two-cycle transfers, data packing and unpacking and data chaining. Block transfers—in addition to source or destination synchronized transfers—are provided.

The interrupt controller provides full programmability of 248 interrupt sources into 32 priority levels with a typical interrupt task switch ("latency") time of 750 ns.

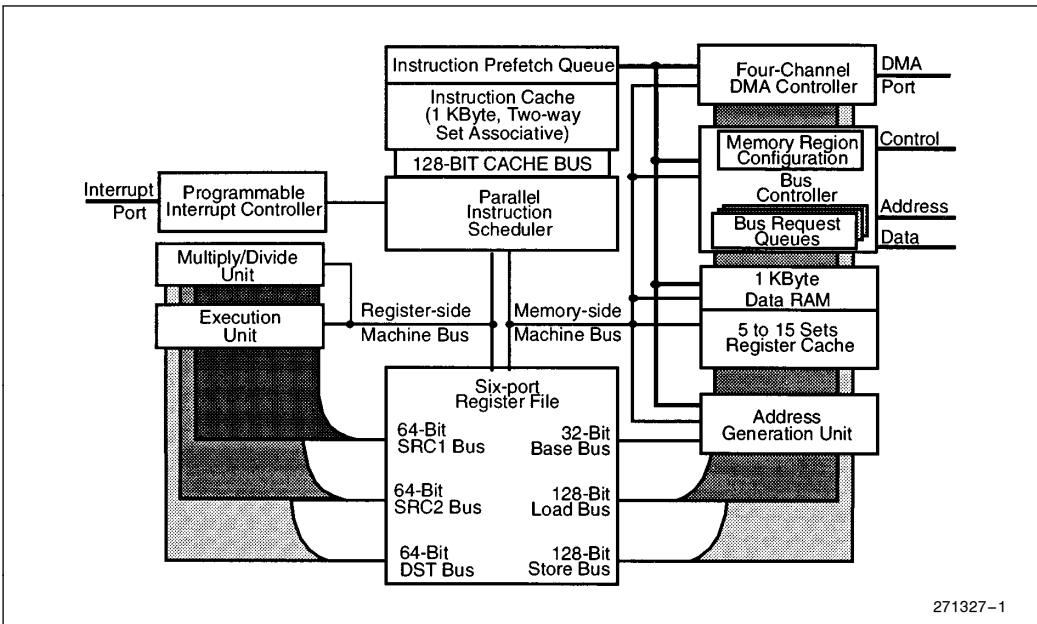

Figure 1. 80960CA Block Diagram

271327-1

2.1 The C-Series Core

The C-Series core is a very high performance micro-architectural implementation of the 80960 Core Architecture. The C-Series core can sustain execution of two instructions per clock (50 MIPs at 25 MHz). To achieve this level of performance, Intel has incorporated state-of-the-art silicon technology and innovative microarchitectural constructs into the implementation of the C-Series core. Factors that contribute to the core's performance include:

- Parallel instruction decoding allows issuance of up to three instructions per clock
- Single-clock execution of most instructions
- Parallel instruction decode allows sustained, simultaneous execution of two single-clock instructions every clock cycle
- Efficient instruction pipeline minimizes pipeline break losses
- Register and resource scoreboarding allow simultaneous multi-clock instruction execution
- Branch look-ahead and prediction allows many branches to execute with no pipeline break
- Local Register Cache integrated on-chip caches Call/Return context
- Two-way set associative, 1 Kbyte integrated instruction cache
- 1 Kbyte integrated Data RAM sustains a four-word (128-bit) access every clock cycle

2.2 Pipelined, Burst Bus

A 32-bit high performance bus controller interfaces the 80960CA to external memory and peripherals. The Bus Control Unit features a maximum transfer rate of 100 Mbytes per second (at 25 MHz). Internally programmable wait states and 16 separately configurable memory regions allow the processor to interface with a variety of memory subsystems with a minimum of system complexity and a maximum of performance. The Bus Controller's main features include:

- Demultiplexed, Burst Bus to exploit most efficient DRAM access modes
- Address Pipelining to reduce memory cost while maintaining performance
- 32-, 16- and 8-bit modes for I/O interfacing ease
- Full internal wait state generation to reduce system cost
- Little and Big Endian support to ease application development
- Unaligned access support for code portability
- Three-deep request queue to decouple the bus from the core

2.3 Flexible DMA Controller

A four-channel DMA controller provides high speed DMA control for data transfers involving peripherals and memory. The DMA provides advanced features such as data chaining, byte assembly and disassembly and a high performance fly-by mode capable of transfer speeds of up to 45 Mbytes per second at 25 MHz. The DMA controller features a performance and flexibility which is only possible by integrating the DMA controller and the 80960CA core.

2.4 Priority Interrupt Controller

A programmable-priority interrupt controller manages up to 248 external sources through the 8-bit external interrupt port. The interrupt Unit also handles the four internal sources from the DMA controller and a single non-maskable interrupt input. The 8-bit interrupt port can also be configured to provide individual interrupt sources that are level or edge triggered.

Interrupts in the 80960CA are prioritized and signaled within 270 ns of the request. If the interrupt is of higher priority than the processor priority, the context switch to the interrupt routine typically is complete in another 480 ns. The interrupt unit provides the mechanism for the low latency and high throughput interrupt service which is essential for embedded applications.

2.5 Instruction Set Summary

Table 1 summarizes the 80960CA instruction set by logical groupings. See the *i960® CA Microprocessor User's Manual* for a complete description of the instruction set.

Table 1. 80960CA Instruction Set

Data Movement	Arithmetic	Logical	Bit and Bit Field and Byte
Load Store Move Load Address	Add Subtract Multiply Divide Remainder Modulo Shift *Extended Shift Extended Multiply Extended Divide Add with Carry Subtract with Carry Rotate	And Not And And Not Or Exclusive Or Not Or Or Not Nor Exclusive Nor Not Nand	Set Bit Clear Bit Not Bit Alter Bit Scan For Bit Span Over Bit Extract Modify Scan Byte for Equal
Comparison	Branch	Call/Return	Fault
Compare Conditional Compare Compare and Increment Compare and Decrement Test Condition Code Check Bit	Unconditional Branch Conditional Branch Compare and Branch	Call Call Extended Call System Return Branch and Link	Conditional Fault Synchronize Faults
Debug	Processor Management	Atomic	
Modify Trace Controls Mark Force Mark	Flush Local Registers Modify Arithmetic Controls Modify Process Controls *System Control *DMA Control	Atomic Add Atomic Modify	

NOTES:

Instructions marked by (*) are 80960CA extensions to the 80960 instruction set

3.0 PACKAGE INFORMATION

3.1 Package Introduction

This section describes the pins, pinouts and thermal characteristics for the 80960CA in the 168-pin Ceramic Pin Grid Array (PGA) package. For complete package specifications and information, see the *Packaging Handbook* (Order No. 240800).

3.2 Pin Descriptions

The 80960CA pins are described in this section. Table 2 presents the legend for interpreting the pin descriptions in the following tables. Pins associated with the 32-bit demultiplexed processor bus are described in Table 3. Pins associated with basic processor configuration and control are described in Table 4. Pins associated with the 80960CA DMA Controller and Interrupt Unit are described in Table 5.

All pins float while the processor is in the ONCE mode.

Table 2. Pin Description Nomenclature

Symbol	Description
I	Input only pin
O	Output only pin
I/O	Pin can be either an input or output
—	Pins “must be” connected as described
S(...)	Synchronous. Inputs must meet setup and hold times relative to PCLK2:1 for proper operation. All outputs are synchronous to PCLK2:1. S(E) Edge sensitive input S(L) Level sensitive input
A(...)	Asynchronous. Inputs may be asynchronous to PCLK2:1. A(E) Edge sensitive input A(L) Level sensitive input
H(...)	While the processor’s bus is in the Hold Acknowledge or Bus Backoff state, the pin: H(1) is driven to V_{CC} H(0) is driven to V_{SS} H(Z) floats H(Q) continues to be a valid input
R(...)	While the processor’s \overline{RESET} pin is low, the pin: R(1) is driven to V_{CC} R(0) is driven to V_{SS} R(Z) floats R(Q) continues to be a valid output

Table 3. 80960CA Pin Description—External Bus Signals

Name	Type	Description																																				
A31:2	O S H(Z) R(Z)	ADDRESS BUS carries the physical address' upper 30 bits. A31 is the most significant address bit; A2 is the least significant. During a bus access, A31:2 identify all external addresses to word (4-byte) boundaries. The byte enable signals indicate the selected byte in each word. During burst accesses, A3:2 increment to indicate successive data cycles.																																				
D31:0	I/O S(L) H(Z) R(Z)	DATA BUS carries 32-, 16- or 8-bit data quantities depending on bus width configuration. The least significant bit of the data is carried on D0 and the most significant on D31. When the bus is configured for 8-bit data, the lower 8 data lines, D7:0 are used. For 16-bit data bus widths, D15:0 are used. For 32 bit bus widths the full data bus is used.																																				
$\overline{\text{BE}}_{3:0}$	O S H(Z) R(1)	<p>BYTE ENABLES select which of the four bytes addressed by A31:2 are active during an access to a memory region configured for a 32-bit data-bus width. $\overline{\text{BE}}_3$ applies to D31:24; $\overline{\text{BE}}_2$ applies to D23:16; $\overline{\text{BE}}_1$ applies to D15:8; $\overline{\text{BE}}_0$ applies to D7:0.</p> <p>32-bit bus:</p> <table style="width: 100%; border: none;"> <tr> <td style="width: 30%;">$\overline{\text{BE}}_3$</td> <td style="width: 40%;">—Byte Enable 3</td> <td style="width: 30%;">—enable D31:24</td> </tr> <tr> <td>$\overline{\text{BE}}_2$</td> <td>—Byte Enable 2</td> <td>—enable D23:16</td> </tr> <tr> <td>$\overline{\text{BE}}_1$</td> <td>—Byte Enable 1</td> <td>—enable D15:8</td> </tr> <tr> <td>$\overline{\text{BE}}_0$</td> <td>—Byte Enable 0</td> <td>—enable D7:0</td> </tr> </table> <p>For accesses to a memory region configured for a 16-bit data-bus width, the processor uses the $\overline{\text{BE}}_3$, $\overline{\text{BE}}_1$ and $\overline{\text{BE}}_0$ pins as $\overline{\text{BHE}}$, A1 and $\overline{\text{BLE}}$ respectively.</p> <p>16-bit bus:</p> <table style="width: 100%; border: none;"> <tr> <td style="width: 30%;">$\overline{\text{BE}}_3$</td> <td style="width: 40%;">—Byte High Enable ($\overline{\text{BHE}}$)</td> <td style="width: 30%;">—enable D15:8</td> </tr> <tr> <td>$\overline{\text{BE}}_2$</td> <td>—Not used (driven high or low)</td> <td></td> </tr> <tr> <td>$\overline{\text{BE}}_1$</td> <td>—Address Bit 1 (A1)</td> <td></td> </tr> <tr> <td>$\overline{\text{BE}}_0$</td> <td>—Byte Low Enable ($\overline{\text{BLE}}$)</td> <td>—enable D7:0</td> </tr> </table> <p>For accesses to a memory region configured for an 8-bit data-bus width, the processor uses the $\overline{\text{BE}}_1$ and $\overline{\text{BE}}_0$ pins as A1 and A0 respectively.</p> <p>8-bit bus:</p> <table style="width: 100%; border: none;"> <tr> <td style="width: 30%;">$\overline{\text{BE}}_3$</td> <td style="width: 40%;">—Not used (driven high or low)</td> <td style="width: 30%;"></td> </tr> <tr> <td>$\overline{\text{BE}}_2$</td> <td>—Not used (driven high or low)</td> <td></td> </tr> <tr> <td>$\overline{\text{BE}}_1$</td> <td>—Address Bit 1 (A1)</td> <td></td> </tr> <tr> <td>$\overline{\text{BE}}_0$</td> <td>—Address Bit 0 (A0)</td> <td></td> </tr> </table>	$\overline{\text{BE}}_3$	—Byte Enable 3	—enable D31:24	$\overline{\text{BE}}_2$	—Byte Enable 2	—enable D23:16	$\overline{\text{BE}}_1$	—Byte Enable 1	—enable D15:8	$\overline{\text{BE}}_0$	—Byte Enable 0	—enable D7:0	$\overline{\text{BE}}_3$	—Byte High Enable ($\overline{\text{BHE}}$)	—enable D15:8	$\overline{\text{BE}}_2$	—Not used (driven high or low)		$\overline{\text{BE}}_1$	—Address Bit 1 (A1)		$\overline{\text{BE}}_0$	—Byte Low Enable ($\overline{\text{BLE}}$)	—enable D7:0	$\overline{\text{BE}}_3$	—Not used (driven high or low)		$\overline{\text{BE}}_2$	—Not used (driven high or low)		$\overline{\text{BE}}_1$	—Address Bit 1 (A1)		$\overline{\text{BE}}_0$	—Address Bit 0 (A0)	
$\overline{\text{BE}}_3$	—Byte Enable 3	—enable D31:24																																				
$\overline{\text{BE}}_2$	—Byte Enable 2	—enable D23:16																																				
$\overline{\text{BE}}_1$	—Byte Enable 1	—enable D15:8																																				
$\overline{\text{BE}}_0$	—Byte Enable 0	—enable D7:0																																				
$\overline{\text{BE}}_3$	—Byte High Enable ($\overline{\text{BHE}}$)	—enable D15:8																																				
$\overline{\text{BE}}_2$	—Not used (driven high or low)																																					
$\overline{\text{BE}}_1$	—Address Bit 1 (A1)																																					
$\overline{\text{BE}}_0$	—Byte Low Enable ($\overline{\text{BLE}}$)	—enable D7:0																																				
$\overline{\text{BE}}_3$	—Not used (driven high or low)																																					
$\overline{\text{BE}}_2$	—Not used (driven high or low)																																					
$\overline{\text{BE}}_1$	—Address Bit 1 (A1)																																					
$\overline{\text{BE}}_0$	—Address Bit 0 (A0)																																					
$\text{W}/\overline{\text{R}}$	O S H(Z) R(0)	WRITE/READ is asserted for read requests and deasserted for write requests. The $\text{W}/\overline{\text{R}}$ signal changes in the same clock cycle as $\overline{\text{ADS}}$. It remains valid for the entire access in non-pipelined regions. In pipelined regions, $\text{W}/\overline{\text{R}}$ is not guaranteed to be valid in the last cycle of a read access.																																				
$\overline{\text{ADS}}$	O S H(Z) R(1)	ADDRESS STROBE indicates a valid address and the start of a new bus access. $\overline{\text{ADS}}$ is asserted for the first clock of a bus access.																																				

Table 3. 80960CA Pin Description—External Bus Signals (Continued)

Name	Type	Description
READY	I S(L) H(Z) R(Z)	READY is an input which signals the termination of a data transfer. $\overline{\text{READY}}$ is used to indicate that read data on the bus is valid or that a write-data transfer has completed. The $\overline{\text{READY}}$ signal works in conjunction with the internally programmed wait-state generator. If $\overline{\text{READY}}$ is enabled in a region, the pin is sampled after the programmed number of wait-states has expired. If the $\overline{\text{READY}}$ pin is deasserted, wait states continue to be inserted until $\overline{\text{READY}}$ becomes asserted. This is true for the N_{RAD} , N_{RDD} , N_{WAD} and N_{WDD} wait states. The N_{XDA} wait states cannot be extended.
BTERM	I S(L) H(Z) R(Z)	BURST TERMINATE is an input which breaks up a burst access and causes another address cycle to occur. The $\overline{\text{BTERM}}$ signal works in conjunction with the internally programmed wait-state generator. If $\overline{\text{READY}}$ and $\overline{\text{BTERM}}$ are enabled in a region, the $\overline{\text{BTERM}}$ pin is sampled after the programmed number of wait states has expired. When $\overline{\text{BTERM}}$ is asserted, a new ADS signal is generated and the access is completed. The $\overline{\text{READY}}$ input is ignored when $\overline{\text{BTERM}}$ is asserted. $\overline{\text{BTERM}}$ must be externally synchronized to satisfy $\overline{\text{BTERM}}$ setup and hold times.
WAIT	O S H(Z) R(1)	WAIT indicates internal wait state generator status. $\overline{\text{WAIT}}$ is asserted when wait states are being caused by the internal wait state generator and not by the $\overline{\text{READY}}$ or $\overline{\text{BTERM}}$ inputs. $\overline{\text{WAIT}}$ can be used to derive a write-data strobe. $\overline{\text{WAIT}}$ can also be thought of as a $\overline{\text{READY}}$ output that the processor provides when it is inserting wait states.
BLAST	O S H(Z) R(0)	BURST LAST indicates the last transfer in a bus access. $\overline{\text{BLAST}}$ is asserted in the last data transfer of burst and non-burst accesses after the wait state counter reaches zero. $\overline{\text{BLAST}}$ remains asserted until the clock following the last cycle of the last data transfer of a bus access. If the $\overline{\text{READY}}$ or $\overline{\text{BTERM}}$ input is used to extend wait states, the $\overline{\text{BLAST}}$ signal remains asserted until $\overline{\text{READY}}$ or $\overline{\text{BTERM}}$ terminates the access.
DT/R	O S H(Z) R(0)	DATA TRANSMIT/RECEIVE indicates direction for data transceivers. $\text{DT}/\overline{\text{R}}$ is used in conjunction with $\overline{\text{DEN}}$ to provide control for data transceivers attached to the external bus. When $\text{DT}/\overline{\text{R}}$ is asserted, the signal indicates that the processor receives data. Conversely, when deasserted, the processor sends data. $\text{DT}/\overline{\text{R}}$ changes only while $\overline{\text{DEN}}$ is high.
DEN	O S H(Z) R(1)	DATA ENABLE indicates data cycles in a bus request. $\overline{\text{DEN}}$ is asserted at the start of the bus request first data cycle and is deasserted at the end of the last data cycle. $\overline{\text{DEN}}$ is used in conjunction with $\text{DT}/\overline{\text{R}}$ to provide control for data transceivers attached to the external bus. $\overline{\text{DEN}}$ remains asserted for sequential reads from pipelined memory regions. $\overline{\text{DEN}}$ is deasserted when $\text{DT}/\overline{\text{R}}$ changes.
LOCK	O S H(Z) R(1)	BUS LOCK indicates that an atomic read-modify-write operation is in progress. $\overline{\text{LOCK}}$ may be used to prevent external agents from accessing memory which is currently involved in an atomic operation. $\overline{\text{LOCK}}$ is asserted in the first clock of an atomic operation and deasserted in the clock cycle following the last bus access for the atomic operation. To allow the most flexibility for memory system enforcement of locked accesses, the processor acknowledges a bus hold request when $\overline{\text{LOCK}}$ is asserted. The processor performs DMA transfers while $\overline{\text{LOCK}}$ is active.
HOLD	I S(L) H(Z) R(Z)	HOLD REQUEST signals that an external agent requests access to the external bus. The processor asserts $\overline{\text{HOLDA}}$ after completing the current bus request. $\overline{\text{HOLD}}$, $\overline{\text{HOLDA}}$ and $\overline{\text{BREQ}}$ are used together to arbitrate access to the processor's external bus by external bus agents.

Table 3. 80960CA Pin Description—External Bus Signals (Continued)

Name	Type	Description
$\overline{\text{BOFF}}$	I S(L) H(Z) R(Z)	BUS BACKOFF , when asserted, suspends the current access and causes the bus pins to float. When $\overline{\text{BOFF}}$ is deasserted, the $\overline{\text{ADS}}$ signal is asserted on the next clock cycle and the access is resumed.
HOLDA	O S H(1) R(Q)	HOLD ACKNOWLEDGE indicates to a bus requestor that the processor has relinquished control of the external bus. When HOLDA is asserted, the external address bus, data bus and bus control signals are floated. HOLD, $\overline{\text{BOFF}}$, HOLDA and BREQ are used together to arbitrate access to the processor's external bus by external bus agents. Since the processor grants HOLD requests and enters the Hold Acknowledge state even while $\overline{\text{RESET}}$ is asserted, the state of the HOLDA pin is independent of the $\overline{\text{RESET}}$ pin.
BREQ	O S H(Q) R(0)	BUS REQUEST is asserted when the bus controller has a request pending. BREQ can be used by external bus arbitration logic in conjunction with HOLD and HOLDA to determine when to return mastership of the external bus to the processor.
$\text{D}/\overline{\text{C}}$	O S H(Z) R(Z)	DATA OR CODE is asserted for a data request and deasserted for instruction requests. $\text{D}/\overline{\text{C}}$ has the same timing as $\text{W}/\overline{\text{R}}$.
$\overline{\text{DMA}}$	O S H(Z) R(Z)	DMA ACCESS indicates whether the bus request was initiated by the DMA controller. $\overline{\text{DMA}}$ is asserted for any DMA request. $\overline{\text{DMA}}$ is deasserted for all other requests.
$\overline{\text{SUP}}$	O S H(Z) R(Z)	SUPERVISOR ACCESS indicates whether the bus request is issued while in supervisor mode. $\overline{\text{SUP}}$ is asserted when the request has supervisor privileges and is deasserted otherwise. $\overline{\text{SUP}}$ can be used to isolate supervisor code and data structures from non-supervisor requests.

Table 4. 80960CA Pin Description—Processor Control Signals

Name	Type	Description
RESET	I A(L) H(Z) R(Z)	<p>RESET causes the chip to reset. When $\overline{\text{RESET}}$ is asserted, all external signals return to the reset state. When $\overline{\text{RESET}}$ is deasserted, initialization begins. When the 2-x clock mode is selected, $\overline{\text{RESET}}$ must remain asserted for 32 CLKIN cycles before being deasserted to guarantee correct processor initialization. When the 1-x clock mode is selected, $\overline{\text{RESET}}$ must remain asserted for 10,000 CLKIN cycles before being deasserted to guarantee correct processor initialization. The CLKMODE pin selects 1-x or 2-x input clock division of the CLKIN pin.</p> <p>The processor's Hold Acknowledge bus state functions while the chip is reset. If the processor's bus is in the Hold Acknowledge state when $\overline{\text{RESET}}$ is asserted, the processor will internally reset, but maintains the Hold Acknowledge state on external pins until the Hold request is removed. If a Hold request is made while the processor is in the reset state, the processor bus will grant HOLDA and enter the Hold Acknowledge state.</p>
FAIL	O S H(Q) R(O)	<p>FAIL indicates failure of the processor's self-test performed at initialization. When $\overline{\text{RESET}}$ is deasserted and the processor begins initialization, the FAIL pin is asserted. An internal self-test is performed as part of the initialization process. If this self-test passes, the FAIL pin is deasserted; otherwise it remains asserted. The FAIL pin is reasserted while the processor performs an external bus self-confidence test. If this self-test passes, the processor deasserts the FAIL pin and branches to the user's initialization routine; otherwise the FAIL pin remains asserted. Internal self-test and the use of the FAIL pin can be disabled with the STEST pin.</p>
STEST	I S(L) H(Z) R(Z)	<p>SELF TEST causes the processor's internal self-test feature to be enabled or disabled at initialization. STEST is read on the rising edge of $\overline{\text{RESET}}$. When asserted, the processor's internal self-test and external bus confidence tests are performed during processor initialization. When deasserted, only the bus confidence tests are performed during initialization.</p>
ONCE	I A(L) H(Z) R(Z)	<p>ON CIRCUIT EMULATION, when asserted, causes all outputs to be floated. $\overline{\text{ONCE}}$ is continuously sampled while $\overline{\text{RESET}}$ is low and is latched on the rising edge of $\overline{\text{RESET}}$. To place the processor in the ONCE state:</p> <ol style="list-style-type: none"> (1) assert $\overline{\text{RESET}}$ and $\overline{\text{ONCE}}$ (order does not matter) (2) wait for at least 16 CLKIN periods in 2-x mode—or 10,000 CLKIN periods in 1-x mode—after V_{CC} and CLKIN are within operating specifications (3) deassert $\overline{\text{RESET}}$ (4) wait at least 32 CLKIN periods <p>(The processor will now be latched in the $\overline{\text{ONCE}}$ state as long as $\overline{\text{RESET}}$ is high.)</p> <p>To exit the ONCE state, bring V_{CC} and CLKIN to operating conditions, then assert $\overline{\text{RESET}}$ and bring $\overline{\text{ONCE}}$ high prior to deasserting $\overline{\text{RESET}}$.</p> <p>CLKIN must operate within the specified operating conditions of the processor until Step 4 above has been completed. CLKIN may then be changed to DC to achieve the lowest possible ONCE mode leakage current.</p> <p>$\overline{\text{ONCE}}$ can be used by emulator products or for board testers to effectively make an installed processor transparent in the board.</p>

Table 4. 80960CA Pin Description—Processor Control Signals (Continued)

Name	Type	Description
CLKIN	I A(E) H(Z) R(Z)	CLOCK INPUT is an input for the external clock needed to run the processor. The external clock is internally divided as prescribed by the CLKMODE pin to produce PCLK2:1.
CLKMODE	I A(L) H(Z) R(Z)	CLOCK MODE selects the division factor applied to the external clock input (CLKIN). When CLKMODE is high, CLKIN is divided by one to create PCLK2:1 and the processor's internal clock. When CLKMODE is low, CLKIN is divided by two to create PCLK2:1 and the processor's internal clock. CLKMODE should be tied high or low in a system as the clock mode is not latched by the processor. If left unconnected, the processor will internally pull the CLKMODE pin low, enabling the 2-x clock mode.
PCLK2:1	O S H(Q) R(Q)	PROCESSOR OUTPUT CLOCKS provide a timing reference for all processor inputs and outputs. All input and output timings are specified in relation to PCLK2 and PCLK1. PCLK2 and PCLK1 are identical signals. Two output pins are provided to allow flexibility in the system's allocation of capacitive loading on the clock. PCLK2:1 may also be connected at the processor to form a single clock signal.
V_{SS}	—	GROUND connections must be connected externally to a V _{SS} board plane.
V_{CC}	—	POWER connections must be connected externally to a V _{CC} board pane.
V_{CCPLL}	—	V_{CCPLL} is a separate V _{CC} supply pin for the phase lock loop used in 1-x clock mode. Connecting a simple lowpass filter to V _{CCPLL} may help reduce clock jitter (T _{CP}) in noisy environments. Otherwise, V _{CCPLL} should be connected to V _{CC} . This pin is implemented starting with the D-stepping. See Table 13 for die stepping information.
NC	—	NO CONNECT pins must not be connected in a system.

Table 5. 80960CA Pin Description—DMA and Interrupt Unit Control Signals

Name	Type	Description
$\overline{\text{DREQ}}3:0$	I A(L) H(Z) R(Z)	DMA REQUEST causes a DMA transfer to be requested. Each of the four signals requests a transfer on a single channel. $\overline{\text{DREQ}}0$ requests channel 0, $\overline{\text{DREQ}}1$ requests channel 1, etc. When two or more channels are requested simultaneously, the channel with the highest priority is serviced first. The channel priority mode is programmable.
$\overline{\text{DACK}}3:0$	O S H(1) R(1)	DMA ACKNOWLEDGE indicates that a DMA transfer is being executed. Each of the four signals acknowledges a transfer for a single channel. $\overline{\text{DACK}}0$ acknowledges channel 0, $\overline{\text{DACK}}1$ acknowledges channel 1, etc. $\overline{\text{DACK}}3:0$ are asserted when the requesting device of a DMA is accessed.
$\overline{\text{EOP}}/\overline{\text{TC}}3:0$	I/O A(L) H(Z/Q) R(Z)	END OF PROCESS/TERMINAL COUNT can be programmed as either an input ($\overline{\text{EOP}}3:0$) or as an output ($\overline{\text{TC}}3:0$), but not both. Each pin is individually programmable. When programmed as an input, $\overline{\text{EOP}}x$ causes the termination of a current DMA transfer for the channel corresponding to the $\overline{\text{EOP}}x$ pin. $\overline{\text{EOP}}0$ corresponds to channel 0, $\overline{\text{EOP}}1$ corresponds to channel 1, etc. When a channel is configured for source <i>and</i> destination chaining, the $\overline{\text{EOP}}$ pin for that channel causes termination of only the current buffer transferred and causes the next buffer to be transferred. $\overline{\text{EOP}}3:0$ are asynchronous inputs. When programmed as an output, the channel's $\overline{\text{TC}}x$ pin indicates that the channel byte count has reached 0 and a DMA has terminated. $\overline{\text{TC}}x$ is driven with the same timing as $\overline{\text{DACK}}x$ during the last DMA transfer for a buffer. If the last bus request is executed as multiple bus accesses, $\overline{\text{TC}}x$ will stay asserted for the entire bus request.
$\overline{\text{XINT}}7:0$	I A(E/L) H(Z) R(Z)	EXTERNAL INTERRUPT PINS cause interrupts to be requested. These pins can be configured in three modes: Dedicated Mode: each pin is a dedicated external interrupt source. Dedicated inputs can be individually programmed to be level (low) or edge (falling) activated. Expanded Mode: the eight pins act together as an 8-bit vectored interrupt source. The interrupt pins in this mode are level activated. Since the interrupt pins are active low, the vector number requested is the one's complement of the positive logic value placed on the port. This eliminates glue logic to interface to combinational priority encoders which output negative logic. Mixed Mode: $\overline{\text{XINT}}7:5$ are dedicated sources and $\overline{\text{XINT}}4:0$ act as the five most significant bits of an expanded mode vector. The least significant bits are set to 010 internally.
$\overline{\text{NMI}}$	I A(E) H(Z) R(Z)	NON-MASKABLE INTERRUPT causes a non-maskable interrupt event to occur. $\overline{\text{NMI}}$ is the highest priority interrupt recognized. $\overline{\text{NMI}}$ is an edge (falling) activated source.

3.3 80960CA Mechanical Data

3.3.1 80960CA PGA Pinout

Tables 6 and 7 list the 80960CA pin names with package location. Figure 2 depicts the complete 80960CA PGA pinout as viewed from the top side of

the component (i.e., pins facing down). Figure 3 shows the complete 80960CA PGA pinout as viewed from the pin-side of the package (i.e., pins facing up). See **Section 4.0, ELECTRICAL SPECIFICATIONS** for specifications and recommended connections.

Table 6. 80960CA PGA Pinout—In Signal Order

Address Bus		Data Bus		Bus Control		Processor Control		I/O	
Signal	Pin	Signal	Pin	Signal	Pin	Signal	Pin	Signal	Pin
A31	S15	D31	R3	$\overline{BE3}$	S5	\overline{RESET}	A16	$\overline{DREQ3}$	A7
A30	Q13	D30	Q5	$\overline{BE2}$	S6			$\overline{DREQ2}$	B6
A29	R14	D29	S2	$\overline{BE1}$	S7	\overline{FAIL}	A2	$\overline{DREQ1}$	A6
A28	Q14	D28	Q4	$\overline{BE0}$	R9			$\overline{DREQ0}$	B5
A27	S16	D27	R2			STEST	B2		
A26	R15	D26	Q3	W/R	S10			$\overline{DACK3}$	A10
A25	S17	D25	S1			\overline{ONCE}	C3	$\overline{DACK2}$	A9
A24	Q15	D24	R1	\overline{ADS}	R6			$\overline{DACK1}$	A8
A23	R16	D23	Q2			CLKIN	C13	$\overline{DACK0}$	B8
A22	R17	D22	P3	\overline{READY}	S3	CLKMODE	C14		
A21	Q16	D21	Q1	\overline{BTERM}	R4	PLCK1	B14	$\overline{EOP/TC3}$	A14
A20	P15	D20	P2			PLCK2	B13	$\overline{EOP/TC2}$	A13
A19	P16	D19	P1	\overline{WAIT}	S12			$\overline{EOP/TC1}$	A12
A18	Q17	D18	N2	\overline{BLAST}	S8	V_{SS}		$\overline{EOP/TC0}$	A11
A17	P17	D17	N1			<i>Location</i>			
A16	N16	D16	M1	DT/R	S11	C7, C8, C9, C10, C11, C12, F15, G3, G15, H3, H15, J3, J15, K3, K15, L3, L15, M3, M15, Q7, Q8, Q9, Q10, Q11		$\overline{XINT7}$	C17
A15	N17	D15	L1	\overline{DEN}	S9			$\overline{XINT6}$	C16
A14	M17	D14	L2					$\overline{XINT5}$	B17
A13	L16	D13	K1	\overline{LOCK}	S14			$\overline{XINT4}$	C15
A12	L17	D12	J1					$\overline{XINT3}$	B16
A11	K17	D11	H1			V_{CC}		$\overline{XINT2}$	A17
A10	J17	D10	H2	HOLD	R5	<i>Location</i>		$\overline{XINT1}$	A15
A9	H17	D9	G1	HOLDA	S4	B7, B9, B11, B12, C6, E15, F3, F16, G2, H16, J2, J16, K2, K16, M2, M16, N3, N15, Q6, R7, R8, R10, R11		$\overline{XINT0}$	B15
A8	G17	D8	F1	\overline{BREQ}	R13				
A7	G16	D7	E1					\overline{NMI}	D15
A6	F17	D6	F2	D/C	S13				
A5	E17	D5	D1	\overline{DMA}	R12				
A4	E16	D4	E2	\overline{SUP}	Q12	V _{CCPLL}	B10		
A3	D17	D3	C1			No Connect			
A2	D16	D2	D2	\overline{BOFF}	B1	<i>Location</i>			
		D1	C2			A1, A3, A4, A5, B3, B4, C4, C5, D3			
		D0	E3						

Table 7. 80960CA PGA Pinout—In Pin Order

Pin	Signal	Pin	Signal	Pin	Signal	Pin	Signal	Pin	Signal
A1	NC	C1	D3	G1	D9	M1	D16	R1	D24
A2	FAIL	C2	D1	G2	V _{CC}	M2	V _{CC}	R2	D27
A3	NC	C3	ONCE	G3	V _{SS}	M3	V _{SS}	R3	D31
A4	NC	C4	NC	G15	V _{SS}	M15	V _{SS}	R4	BTERM
A5	NC	C5	NC	G16	A7	M16	V _{CC}	R5	HOLD
A6	DREQ1	C6	V _{CC}	G17	A8	M17	A14	R6	ADS
A7	DREQ3	C7	V _{SS}					R7	V _{CC}
A8	DACK1	C8	V _{SS}	H1	D11	N1	D17	R8	V _{CC}
A9	DACK2	C9	V _{SS}	H2	D10	N2	D18	R9	BE0
A10	DACK3	C10	V _{SS}	H3	V _{SS}	N3	V _{CC}	R10	V _{CC}
A11	EOP/TC0	C11	V _{SS}	H15	V _{SS}	N15	V _{CC}	R11	V _{CC}
A12	EOP/TC1	C12	V _{SS}	H16	V _{CC}	N16	A16	R12	DMA
A13	EOP/TC2	C13	CLKIN	H17	A9	N17	A15	R13	BREQ
A14	EOP/TC3	C14	CLKMODE					R14	A29
A15	XINT1	C15	XINT4	J1	D12	P1	D19	R15	A26
A16	RESET	C16	XINT6	J2	V _{CC}	P2	D20	R16	A23
A17	XINT2	C17	XINT7	J3	V _{SS}	P3	D22	R17	A22
				J15	V _{SS}	P15	A20		
B1	BOFF	D1	D5	J16	V _{CC}	P16	A19	S1	D25
B2	STEST	D2	D2	J17	A10	P17	A17	S2	D29
B3	NC	D3	NC					S3	READY
B4	NC	D15	NMI	K1	D13	Q1	D21	S4	HOLDA
B5	DREQ0	D16	A2	K2	V _{CC}	Q2	D23	S5	BE3
B6	DREQ2	D17	A3	K3	V _{SS}	Q3	D26	S6	BE2
B7	V _{CC}			K15	V _{SS}	Q4	Q28	S7	BE1
B8	DACK0	E1	D7	K16	V _{CC}	Q5	D30	S8	BLAST
B9	V _{CC}	E2	D4	K17	A11	Q6	V _{CC}	S9	DEN
B10	V _{CC} PLL	E3	D0			Q7	V _{SS}	S10	W/R
B11	V _{CC}	E15	V _{CC}	L1	D15	Q8	V _{SS}	S11	DT/R
B12	V _{CC}	E16	A4	L2	D14	Q9	V _{SS}	S12	WAIT
B13	PCLK2	E17	A5	L3	V _{SS}	Q10	V _{SS}	S13	D/C
B14	PCLK1			L15	V _{SS}	Q11	V _{SS}	S14	LOCK
B15	XINT0	F1	D8	L16	A13	Q12	SUP	S15	A31
B16	XINT3	F2	D6	L17	A12	Q13	A30	S16	A27
B17	XINT5	F3	V _{CC}			Q14	A28	S17	A25
		F15	V _{SS}			Q15	A24		
		F16	V _{CC}			Q16	A21		
		F17	A6			Q17	A18		

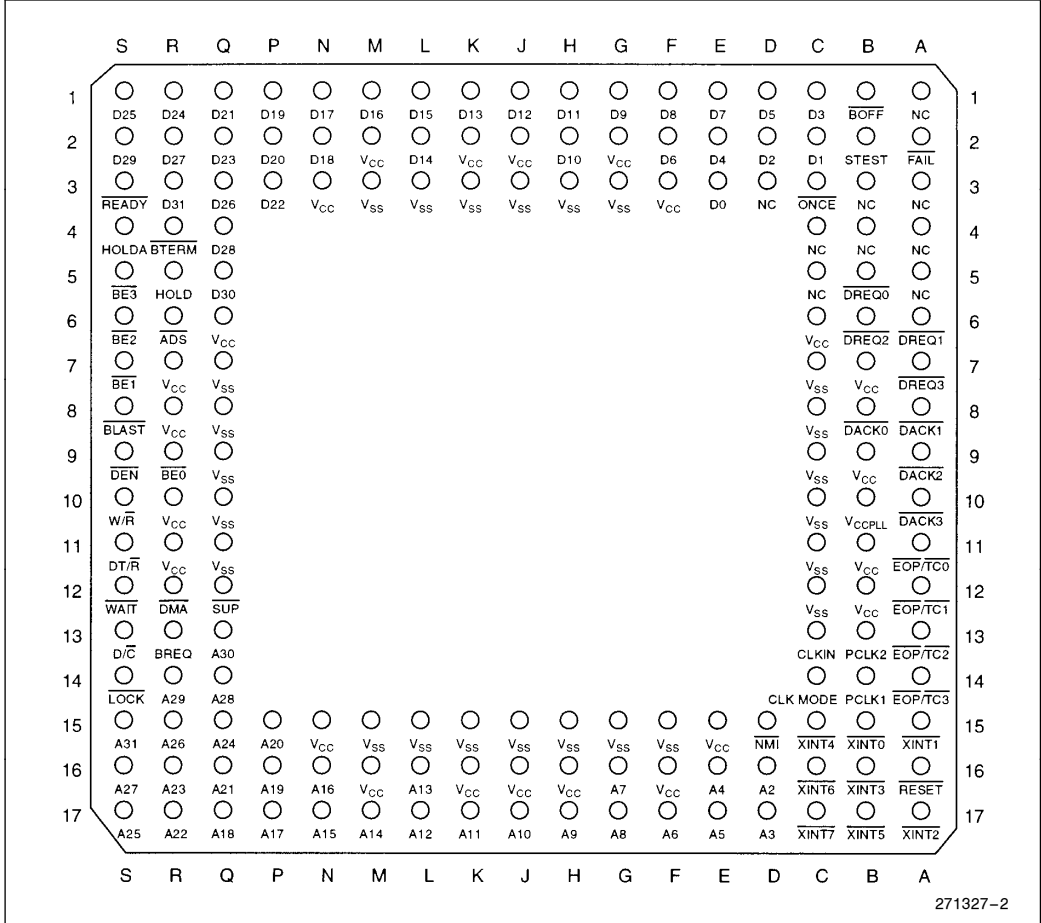
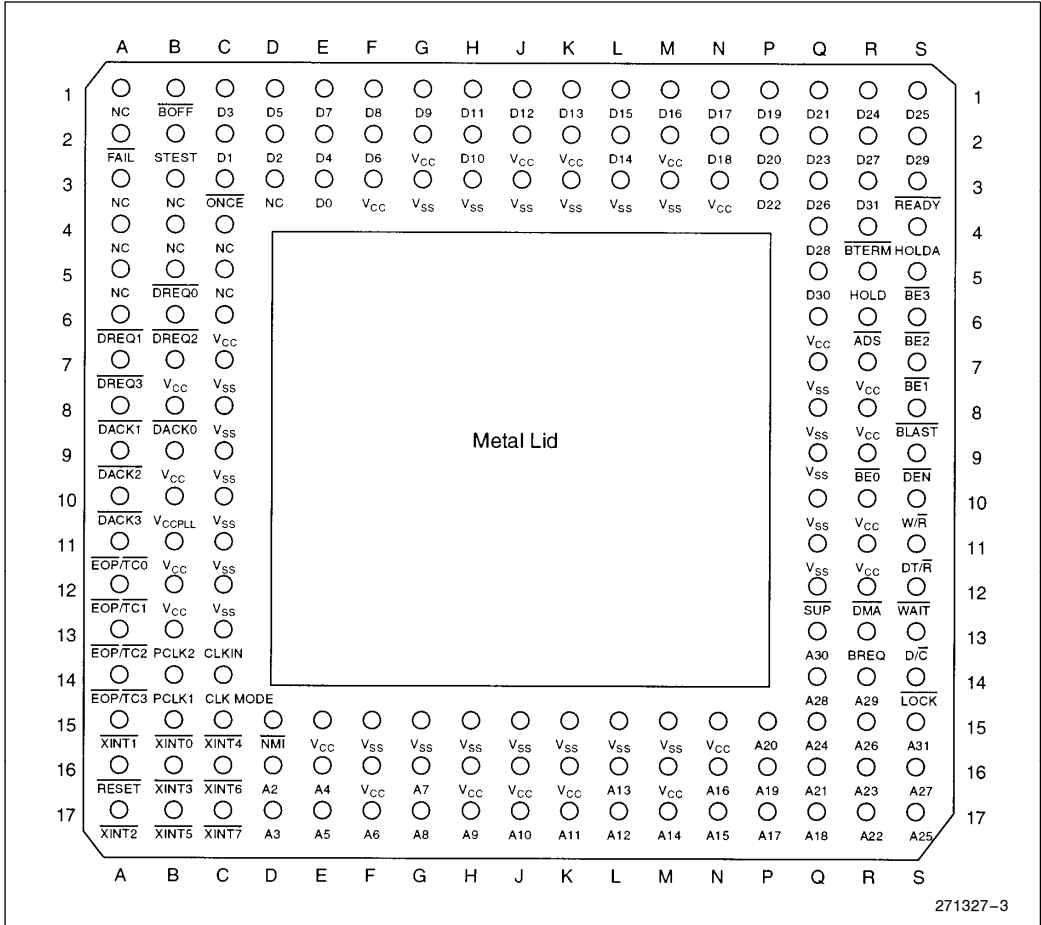

Figure 2. 80960CA PGA Pinout—View from Top (Pins Facing Down)



271327-3

Figure 3. 80960CA PGA Pinout—View Lid from Bottom (Pins Facing Up)

3.4 Package Thermal Specifications

The 80960CA is specified for operation when T_C (case temperature) is within the range of -40°C – $+110^{\circ}\text{C}$. T_C may be measured in any environment to determine whether the 80960CA is within specified operating range. Case temperature should be measured at the center of the top surface, opposite the pins. Refer to Figure 4.

T_A (ambient temperature) can be calculated from θ_{CA} (thermal resistance from case to ambient) using the following equation:

$$T_A = T_C - P \cdot \theta_{CA}$$

Table 8 shows the maximum T_A allowable (without exceeding T_C) at various airflows and operating frequencies (f_{PCLK}).

Note that T_A is greatly improved by attaching fins or a heatsink to the package. P (maximum power consumption) is calculated by using the typical I_{CC} as tabulated in **Section 4.4, DC Specifications** and V_{CC} of 5V.

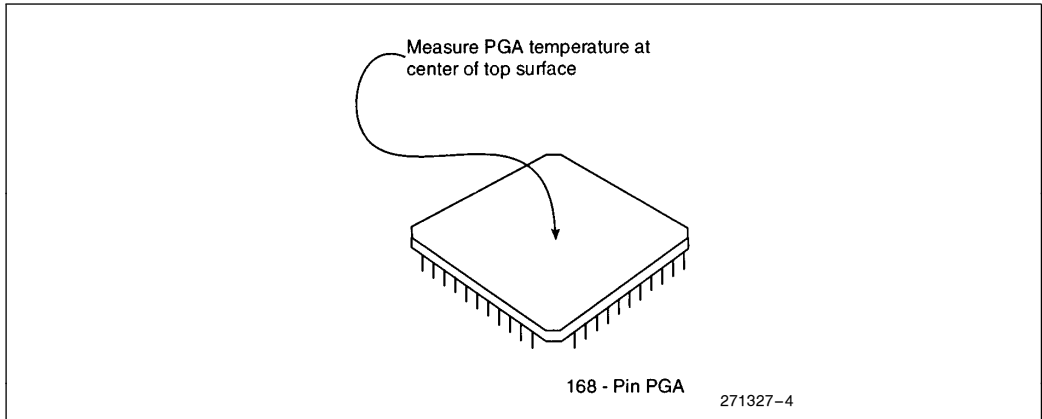

Figure 4. Measuring 80960CA PGA Case Temperature

Table 8. Maximum T_A at Various Airflows in $^{\circ}\text{C}$

	f_{PCLK} (MHz)	Airflow-ft/min (m/sec)					
		0 (0)	200 (1.01)	400 (2.03)	600 (3.04)	800 (4.06)	1000 (5.07)
T_A with Heatsink*	33	51	66	79	81	85	87
	25	61	73	83	85	88	89
	16	74	82	89	90	92	93
T_A without Heatsink*	33	36	47	59	66	73	75
	25	49	58	67	73	78	80
	16	66	72	78	82	86	87

NOTES:

0.285" high unidirectional heatsink (Al alloy 6061, 50 mil fin width, 150 mil center-to-center fin spacing).

Table 9. 80960CA PGA Package Thermal Characteristics

Thermal Resistance—°C/Watt						
Parameter	Airflow—ft/min (m/sec)					
	0 (0)	200 (1.01)	400 (2.03)	600 (3.07)	800 (4.06)	1000 (5.07)
θ Junction-to-Case (Case measured as shown in Figure 4)	1.5	1.5	1.5	1.5	1.5	1.5
θ Case-to-Ambient (No Heatsink)	17	14	11	9	7.1	6.6
θ Case-to-Ambient (With Heatsink)*	13	9	5.5	5	3.9	3.4

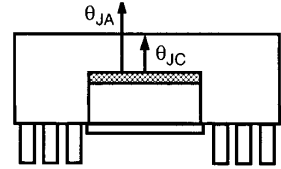

NOTES:

1. This table applies to 80960CA PGA plugged into socket or soldered directly to board.

2. $\theta_{JA} = \theta_{JC} + \theta_{CA}$.

*0.285" high unidirectional heatsink (Al alloy 6061, 50 mil fin width, 150 mil center-to-center fin spacing).

3.5 Stepping Register Information

Upon reset, register g0 contains die stepping information. Figure 5 shows how g0 is configured. The most significant byte contains an ASCII 0. The upper middle byte contains an ASCII C. The lower middle byte contains an ASCII A. The least significant byte contains the stepping number in ASCII. g0 retains this information until it is overwritten by the user program.

ASCII	00	43	41	Stepping Number
DECIMAL	0	C	A	Stepping Number
	MSB		LSB	

Figure 5. Register g0

Table 10 contains a cross reference of the number in the least significant byte of register g0 to the die stepping number.

Table 10. Die Stepping Cross Reference

g0 Least Significant Byte	Die Stepping
01	B
02	C-1
03	C-2,C-3
04	D

3.6 Suggested Sources for 80960CA Accessories

The following is a list of suggested sources for 80960CA accessories. This is not an endorsement of any kind, nor is it a warranty of the performance of any of the listed products and/or companies.

Sockets

- 3M Textool Test and Interconnection Products Department
P.O. Box 2963
Austin, TX 78769-2963
- Augat, Inc.
Interconnection Products Group
33 Perry Avenue
P.O. Box 779
Attleboro, MA 02703
(508) 699-7646
- Concept Manufacturing, Inc.
(Decoupling Sockets)
41484 Christy Street
Fremont, CA 94538
(415) 651-3804

Heatsinks/Fins

- Thermalloy, Inc.
2021 West Valley View Lane
Dallas, TX 75234-8993
(214) 243-4321
FAX: (214) 241-4656
- E G & G Division
60 Audubon Road
Wakefield, MA 01880
(617) 245-5900



4.0 ELECTRICAL SPECIFICATIONS

4.1 Absolute Maximum Ratings

Storage Temperature -65°C to +150°C
 Case Temperature Under Bias... -40°C to +110°C
 Supply Voltage
 with Respect to V_{SS} -0.5V to +6.5V
 Voltage on Other Pins
 with Respect to V_{SS} -0.5V to $V_{CC} + 0.5V$

NOTICE: This is a production data sheet. The specifications are subject to change without notice.

**WARNING: Stressing the device beyond the "Absolute Maximum Ratings" may cause permanent damage. These are stress ratings only. Operation beyond the "Operating Conditions" is not recommended and extended exposure beyond the "Operating Conditions" may affect device reliability.*

4.2 Operating Conditions

Table 11. Operating Conditions (80960CA-25, -16)

Symbol	Parameter		Min	Max	Units	Notes
V_{CC}	Supply Voltage	80960CA-25	4.50	5.50	V	
		80960CA-16	4.50	5.50	V	
f_{CLK2x}	Input Clock Frequency (2-x Mode)	80960CA-25	0	50	MHz	
		80960CA-16	0	32	MHz	
f_{CLK1x}	Input Clock Frequency (1-x Mode)	80960CA-25	8	25	MHz	(Note 1)
		80960CA-16	8	16	MHz	
T_C	Case Temperature Under Bias	PGA package 80960CA-25, -16	-40	+110	°C	

NOTES:

- When in the 1-x input clock mode, CLKIN is an input to an internal phase-locked loop and must maintain a minimum frequency of 8 MHz for proper processor operation. However, in the 1-x mode, CLKIN may still be stopped when the processor either is in a reset condition or is reset. If CLKIN is stopped, the specified RESET low time must be provided once CLKIN restarts and has stabilized.
- Case temperatures are "instant on".

4.3 Recommended Connections

Power and ground connections must be made to multiple V_{CC} and V_{SS} (GND) pins. Every 80960CA-based circuit board should include power (V_{CC}) and ground (V_{SS}) planes for power distribution. Every V_{CC} pin must be connected to the power plane, and every V_{SS} pin must be connected to the ground plane. Pins identified as "NC" must not be connected in the system.

Liberal decoupling capacitance should be placed near the 80960CA. The processor can cause transient power surges when its numerous output buffers transition, particularly when connected to large capacitive loads.

Low inductance capacitors and interconnects are recommended for best high frequency electrical performance. Inductance can be reduced by shortening the board traces between the processor and decoupling capacitors as much as possible. Capacitors specifically designed for PGA packages will offer the lowest possible inductance.

For reliable operation, always connect unused inputs to an appropriate signal level. In particular, any unused interrupt (\overline{XINT} , \overline{NMI}) or DMA (\overline{DREQ}) input should be connected to V_{CC} through a pull-up resistor, as should \overline{BTERM} if not used. Pull-up resistors should be in the in the range of 20 K Ω for each pin tied high. If \overline{READY} or \overline{HOLD} are not used, the unused input should be connected to ground. **N.C. pins must always remain unconnected.** Refer to the *i960[®] CA Microprocessor User's Manual* (Order Number 270710) for more information.

4.4 DC Specifications

Table 12. DC Characteristics

 (80960CA-25, -16 under the conditions described in **Section 4.2, Operating Conditions.**)

Symbol	Parameter	Min	Max	Units	Notes
V_{IL}	Input Low Voltage for all pins except $\overline{\text{RESET}}$	-0.3	+0.8	V	
V_{IH}	Input High Voltage for all pins except $\overline{\text{RESET}}$	2.0	$V_{CC} + 0.3$	V	
V_{OL}	Output Low Voltage		0.45	V	$I_{OL} = 5 \text{ mA}$
V_{OH}	Output High Voltage $I_{OH} = -1 \text{ mA}$ $I_{OH} = -200 \mu\text{A}$	2.4 $V_{CC} - 0.5$		V V	
V_{ILR}	Input Low Voltage for $\overline{\text{RESET}}$	-0.3	1.5	V	
V_{IHR}	Input High Voltage for $\overline{\text{RESET}}$	3.5	$V_{CC} + 0.3$	V	
I_{LI1}	Input Leakage Current for each pin <i>except</i> : $\overline{\text{BTERM}}$, $\overline{\text{ONCE}}$, $\overline{\text{DREQ3:0}}$, $\overline{\text{STEST}}$, $\overline{\text{EOP3:0/TC3:0}}$, $\overline{\text{NMI}}$, $\overline{\text{XINT7:0}}$, $\overline{\text{BOFF}}$, $\overline{\text{READY}}$, $\overline{\text{HOLD}}$, $\overline{\text{CLKMODE}}$			± 15 μA	$0 \leq V_{IN} \leq V_{CC}^{(1)}$
I_{LI2}	Input Leakage Current for: $\overline{\text{BTERM}}$, $\overline{\text{ONCE}}$, $\overline{\text{DREQ3:0}}$, $\overline{\text{STEST}}$, $\overline{\text{EOP3:0/TC3:0}}$, $\overline{\text{NMI}}$, $\overline{\text{XINT7:0}}$, $\overline{\text{BOFF}}$	0	-325	μA	$V_{IN} = 0.45\text{V}^{(2)}$
I_{LI3}	Input Leakage Current for: $\overline{\text{READY}}$, $\overline{\text{HOLD}}$, $\overline{\text{CLKMODE}}$	0	500	μA	$V_{IN} = 2.4\text{V}^{(3,7)}$
I_{LO}	Output Leakage Current		± 15	μA	$0.45 \leq V_{OUT} \leq V_{CC}$
I_{CC}	Supply Current (80960CA-25): $I_{CC} \text{ Max}$ $I_{CC} \text{ Typ}$		750 600	mA mA	(Note 4) (Note 5)
I_{CC}	Supply Current (80960CA-16): $I_{CC} \text{ Max}$ $I_{CC} \text{ Typ}$		550 400	mA mA	(Note 4) (Note 5)
I_{ONCE}	ONCE-mode Supply Current		100	mA	
C_{IN}	Input Capacitance for: $\overline{\text{CLKIN}}$, $\overline{\text{RESET}}$, $\overline{\text{ONCE}}$, $\overline{\text{READY}}$, $\overline{\text{HOLD}}$, $\overline{\text{DREQ3:0}}$, $\overline{\text{BOFF}}$, $\overline{\text{XINT7:0}}$, $\overline{\text{NMI}}$, $\overline{\text{BTERM}}$, $\overline{\text{CLKMODE}}$	0	12	pF	$F_C = 1 \text{ MHz}$
C_{OUT}	Output Capacitance of each output pin		12	pF	$F_C = 1 \text{ MHz}^{(6)}$
$C_{I/O}$	I/O Pin Capacitance		12	pF	$F_C = 1 \text{ MHz}$

NOTES:

- No pullup or pulldown.
- These pins have internal pullup resistors.
- These pins have internal pulldown resistors.
- Measured at worst case frequency, V_{CC} and temperature, with device operating and outputs loaded to the test conditions described in **Section 4.5.1, AC Test Conditions.**
- I_{CC} Typical is not tested.
- Output Capacitance is the capacitive load of a floating output.
- $\overline{\text{CLKMODE}}$ pin has a pulldown resistor only when $\overline{\text{ONCE}}$ pin is deasserted.

4.5 AC Specifications

Table 13. 80960CA AC Characteristics (25 MHz)

(80960CA-25 only, under conditions described in **Section 4.2, Operating Conditions** and **Section 4.5.1, AC Test Conditions**.)

Symbol	Parameter	Min	Max	Units	Notes	
Input Clock (1, 9)						
T_F	CLKIN Frequency	0	50	MHz		
T_C	CLKIN Period	In 1-x Mode (f_{CLK1x})	40	125	ns	(11)
		In 2-x Mode (f_{CLK2x})	20	∞	ns	
T_{CS}	CLKIN Period Stability	In 1-x Mode (f_{CLK1x})		$\pm 0.1\%$	Δ	(12)
T_{CH}	CLKIN High Time	In 1-x Mode (f_{CLK1x})	8	62.5	ns	(11)
		In 2-x Mode (f_{CLK2x})	8	∞	ns	
T_{CL}	CLKIN Low Time	In 1-x Mode (f_{CLK1x})	8	62.5	ns	(11)
		In 2-x Mode (f_{CLK2x})	8	∞	ns	
T_{CR}	CLKIN Rise Time	0	6	ns		
T_{CF}	CLKIN Fall Time	0	6	ns		
Output Clocks (1, 8)						
T_{CP}	CLKIN to PCLK2:1 Delay	In 1-x Mode (f_{CLK1x})	-2	2	ns	(3, 12)
		In 2-x Mode (f_{CLK2x})	2	25	ns	(3)
T	PCLK2:1 Period	In 1-x Mode (f_{CLK1x})	T_C		ns	(12)
		In 2-x Mode (f_{CLK2x})	$2T_C$		ns	(3)
T_{PH}	PCLK2:1 High Time	$(T/2) - 3$	$T/2$	ns	(12)	
T_{PL}	PCLK2:1 Low Time	$(T/2) - 3$	$T/2$	ns	(12)	
T_{PR}	PCLK2:1 Rise Time	1	4	ns	(3)	
T_{PF}	PCLK2:1 Fall Time	1	4	ns	(3)	
Synchronous Outputs (8)						
T_{OH} T_{OV}	Output Valid Delay, Output Hold					(6, 10)
	T_{OH1}, T_{OV1}	A31:2	3	16	ns	
	T_{OH2}, T_{OV2}	BE3:0	3	18	ns	
	T_{OH3}, T_{OV3}	ADS	6	20	ns	
	T_{OH4}, T_{OV4}	W/R	3	20	ns	
	T_{OH5}, T_{OV5}	D/C, SUP, DMA	4	18	ns	
	T_{OH6}, T_{OV6}	BLAST, WAIT	5	18	ns	
	T_{OH7}, T_{OV7}	DEN	3	18	ns	
	T_{OH8}, T_{OV8}	HOLDA, BREQ	4	18	ns	
	T_{OH9}, T_{OV9}	LOCK	4	18	ns	
	T_{OH10}, T_{OV10}	DACK3:0	4	20	ns	
	T_{OH11}, T_{OV11}	D31:0	3	18	ns	
	T_{OH12}, T_{OV12}	DT/R	$T/2 + 3$	$T/2 + 16$	ns	
	T_{OH13}, T_{OV13}	FAIL	2	16	ns	
	T_{OH14}, T_{OV14}	EOP3:0/TC3:0	3	20	ns	
T_{OF}	Output Float for all outputs	3	22	ns	(6)	
Synchronous Inputs (1, 9, 10)						
T_{IS}	Input Setup					
	T_{IS1}	D31:0	5		ns	
	T_{IS2}	BOFF	19		ns	
	T_{IS3}	BTERM/READY	9		ns	
T_{IS4}	HOLD	9		ns		
T_{IH}	Input Hold					
	T_{IH1}	D31:0	5		ns	
	T_{IH2}	BOFF	7		ns	
	T_{IH3}	BTERM/READY	2		ns	
T_{IH4}	HOLD	5		ns		

Table 13. 80960CA AC Characteristics (25 MHz) (Continued)

(80960CA-25 only, under conditions described in **Section 4.2, Operating Conditions** and **Section 4.5.1, AC Test Conditions.**)

Symbol	Parameter	Min	Max	Units	Notes
Relative Output Timings (1, 2, 3, 8)					
T _{AVSH1}	A31:2 Valid to \overline{ADS} Rising	T - 4	T + 4	ns	
T _{AVSH2}	$\overline{BE3:0}$, W/ \overline{R} , SUP, D/ \overline{C} , DMA, DACK3:0 Valid to \overline{ADS} Rising	T - 6	T + 6	ns	
T _{AVEL1}	A31:2 Valid to \overline{DEN} Falling	T - 4	T + 4	ns	
T _{AVEL2}	$\overline{BE3:0}$, W/ \overline{R} , SUP, INST, DMA, DACK3:0 Valid to \overline{DEN} Falling	T - 6	T + 6	ns	
T _{NLQV}	WAIT Falling to Output Data Valid	± 4		ns	
T _{DVNH}	Output Data Valid to WAIT Rising	N*T - 4	N*T + 4	ns	(4)
T _{NLNH}	WAIT Falling to WAIT Rising	N*T \pm 4		ns	(4)
T _{NHQX}	Output Data Hold after WAIT Rising	(N + 1)*T - 8	(N + 1)*T + 6	ns	(5)
T _{EHTV}	DT/ \overline{R} Hold after \overline{DEN} High	T/2 - 7	∞	ns	(6)
T _{TVEL}	DT/ \overline{R} Valid to \overline{DEN} Falling	T/2 - 4		ns	
Relative Input Timings (1, 2, 3)					
T _{IS5}	\overline{RESET} Input Setup (2-x Clock Mode)	8		ns	(13)
T _{IH5}	\overline{RESET} Input Hold (2-x Clock Mode)	7		ns	(13)
T _{IS6}	DREQ3:0 Input Setup	14		ns	(7)
T _{IH6}	DREQ3:0 Input Hold	9		ns	(7)
T _{IS7}	XINT7:0, NMI Input Setup	10		ns	(15)
T _{IH7}	XINT7:0, NMI Input Hold	10		ns	(15)
T _{IS8}	\overline{RESET} Input Setup (1-x Clock Mode)	3		ns	(14)
T _{IH8}	\overline{RESET} Input Hold (1-x Clock Mode)	T/4 + 1		ns	(14)

NOTES:

1. See **Section 4.5.2, AC Timing Waveforms** for waveforms and definitions.
2. See Figure 16 for capacitive derating information for output delays and hold times.
3. See Figure 17 for capacitive derating information for rise and fall times.
4. Where N is the number of N_{RAD}, N_{RDD}, N_{WAD} or N_{WDD} wait states that are programmed in the Bus Controller Region Table. WAIT never goes active when there are no wait states in an access.
5. N = Number of wait states inserted with READY.
6. Output Data and/or DT/ \overline{R} may be driven indefinitely following a cycle if there is no subsequent bus activity.
7. Since asynchronous inputs are synchronized internally by the 80960CA, they have no required setup or hold times to be recognized and for proper operation. However, to guarantee recognition of the input at a particular edge of PCLK2:1, the setup times shown must be met. Asynchronous inputs must be active for at least two consecutive PCLK2:1 rising edges to be seen by the processor.
8. These specifications are guaranteed by the processor.
9. These specifications must be met by the system for proper operation of the processor.
10. This timing is dependent upon the loading of PCLK2:1. Use the derating curves of **Section 4.5.3, Derating Curves** to adjust the timing for PCLK2:1 loading.
11. In the 1-x input clock mode, the maximum input clock period is limited to 125 ns while the processor is operating. When the processor is in reset, the input clock may stop even in 1-x mode.
12. When in the 1-x input clock mode, these specifications assume a stable input clock with a period variation of less than $\pm 0.1\%$ between adjacent cycles.
13. In 2-x clock mode, \overline{RESET} is an asynchronous input which has no required setup and hold time for proper operation. However, to guarantee the device exits reset synchronized to a particular clock edge, the \overline{RESET} pin must meet setup and hold times to the falling edge of the CLKIN. (See Figure 21).
14. In 1-x clock mode, \overline{RESET} is an asynchronous input which has no required setup and hold time for proper operation. However, to guarantee the device exits reset synchronized to a particular clock edge, the \overline{RESET} pin must meet setup and hold times to the rising edge of the CLKIN. (See Figure 22.)
15. The interrupt pins are synchronized internally by the 80960CA. They have no required setup or hold times for proper operation. These pins are sampled by the interrupt controller every other clock and must be active for at least three consecutive PCLK2:1 rising edges when asserting them asynchronously. To guarantee recognition at a particular clock edge, the setup and hold times shown must be met for two consecutive PCLK2:1 rising edges.

Table 14. 80960CA AC Characteristics (16 MHz)

(80960CA-16 only, under conditions described in Section 4.2, Operating Conditions and Section 4.5.1, AC Test Conditions.)

Symbol	Parameter	Min	Max	Units	Notes	
Input Clock (1, 9)						
T _F	CLKIN Frequency	0	32	MHz		
T _C	CLKIN Period	In 1-x Mode (f _{CLK1x}) In 2-x Mode (f _{CLK2x})	62.5 31.25	125 ∞	ns ns	(11)
T _{CS}	CLKIN Period Stability	In 1-x Mode (f _{CLK1x})		±0.1%	Δ	(12)
T _{CH}	CLKIN High Time	In 1-x Mode (f _{CLK1x}) In 2-x Mode (f _{CLK2x})	10 10	62.5 ∞	ns ns	(11)
T _{CL}	CLKIN Low Time	In 1-x Mode (f _{CLK1x}) In 2-x Mode (f _{CLK2x})	10 10	62.5 ∞	ns ns	(11)
T _{CR}	CLKIN Rise Time		0	6	ns	
T _{CF}	CLKIN Fall Time		0	6	ns	
Output Clocks (1, 8)						
T _{CP}	CLKIN to PCLK2:1 Delay	In 1-x Mode (f _{CLK1x}) In 2-x Mode (f _{CLK2x})	-2 2	2 25	ns ns	(3, 12) (3)
T	PCLK2:1 Period	In 1-x Mode (f _{CLK1x}) In 2-x Mode (f _{CLK2x})		T _C 2T _C	ns ns	(12) (3)
T _{PH}	PCLK2:1 High Time		(T/2) - 4	T/2	ns	(12)
T _{PL}	PCLK2:1 Low Time		(T/2) - 4	T/2	ns	(12)
T _{PR}	PCLK2:1 Rise Time		1	4	ns	(3)
T _{PF}	PCLK2:1 Fall Time		1	4	ns	(3)
Synchronous Outputs (8)						
T _{OH} T _{OV}	Output Valid Delay, Output Hold					(6, 10)
	T _{OH1} , T _{OV1}	A31:2	3	18	ns	
	T _{OH2} , T _{OV2}	BE3:0	3	20	ns	
	T _{OH3} , T _{OV3}	ADS	6	22	ns	
	T _{OH4} , T _{OV4}	W/R	3	22	ns	
	T _{OH5} , T _{OV5}	D/C, SUP, DMA	4	20	ns	
	T _{OH6} , T _{OV6}	BLAST, WAIT	5	20	ns	
	T _{OH7} , T _{OV7}	DEN	3	20	ns	
	T _{OH8} , T _{OV8}	HOLDA, BREQ	4	20	ns	
	T _{OH9} , T _{OV9}	LOCK	4	20	ns	
	T _{OH10} , T _{OV10}	DACK3:0	4	22	ns	
	T _{OH11} , T _{OV11}	D31:0	3	20	ns	
	T _{OH12} , T _{OV12}	DT/R	T/2 + 3	T/2 + 18	ns	
	T _{OH13} , T _{OV13}	FAIL	2	18	ns	
	T _{OH14} , T _{OV14}	EOP3:0/TC3:0	3	22	ns	(6, 10)
T _{OF}	Output Float for All Outputs		3	22	ns	(6)
Synchronous Inputs (1, 9, 10)						
T _{IS}	Input Setup					
	T _{IS1}	D31:0	5		ns	
	T _{IS2}	BOFF	21		ns	
	T _{IS3}	BTERM/READY	9		ns	
	T _{IS4}	HOLD	9		ns	
T _{IH}	Input Hold					
	T _{IH1}	D31:0	5		ns	
	T _{IH2}	BOFF	7		ns	
	T _{IH3}	BTERM/READY	2		ns	
	T _{IH4}	HOLD	5		ns	

Table 14. 80960CA AC Characteristics (16 MHz) (Continued)

 (80960CA-16 only, under conditions described in **Section 4.2, Operating Conditions** and **Section 4.5.1, AC Test Conditions**.)

Symbol	Parameter	Min	Max	Units	Notes
Relative Output Timings (1, 2, 3, 8)					
T _{AVSH1}	A31:2 Valid to \overline{ADS} Rising	T - 4	T + 4	ns	
T _{AVSH2}	$\overline{BE3:0}$, W/ \overline{R} , SUP, D/ \overline{C} , DMA, DACK3:0 Valid to \overline{ADS} Rising	T - 6	T + 6	ns	
T _{AVEL1}	A31:2 Valid to \overline{DEN} Falling	T - 6	T + 6	ns	
T _{AVEL2}	$\overline{BE3:0}$, W/ \overline{R} , SUP, INST, DMA, DACK3:0 Valid to \overline{DEN} Falling	T - 6	T + 6	ns	
T _{NLQV}	WAIT Falling to Output Data Valid	± 4		ns	
T _{DVNH}	Output Data Valid to WAIT Rising	N*T - 4	N*T + 4	ns	(4)
T _{NLNH}	WAIT Falling to WAIT Rising	N*T \pm 4		ns	(4)
T _{NHGX}	Output Data Hold after WAIT Rising	(N + 1)*T - 8	(N + 1)*T + 4	ns	(5)
T _{EHTV}	DT/ \overline{R} Hold after \overline{DEN} High	T/2 - 7	∞	ns	(6)
T _{TVEL}	DT/ \overline{R} Valid to \overline{DEN} Falling	T/2 - 4		ns	
Relative Input Timings (1, 2, 3)					
T _{IS5}	\overline{RESET} Input Setup (2-x Clock Mode)	10		ns	(13)
T _{IH5}	\overline{RESET} Input Hold (2-x Clock Mode)	9		ns	(13)
T _{IS6}	$\overline{DREQ3:0}$ Input Setup	16		ns	(7)
T _{IH6}	$\overline{DREQ3:0}$ Input Hold	11		ns	(7)
T _{IS7}	XINT7:0 NMI Input Setup	10		ns	(15)
T _{IH7}	XINT7:0 NMI Input Hold	10		ns	(15)
T _{IS8}	\overline{RESET} Input Setup (1-x Clock Mode)	3		ns	(14)
T _{IH8}	\overline{RESET} Input Hold (1-x Clock Mode)	T/4 + 1		ns	(14)

NOTES:

- See **Section 4.5.2, AC Timing Waveforms** for waveforms and definitions.
- See Figure 16 for capacitive derating information for output delays and hold times.
- See Figure 17 for capacitive derating information for rise and fall times.
- Where N is the number of N_{RAD}, N_{RDD}, N_{WAD} or N_{WDD} wait states that are programmed in the Bus Controller Region Table. WAIT never goes active when there are no wait states in an access.
- N = Number of wait states inserted with READY.
- Output Data and/or DT/ \overline{R} may be driven indefinitely following a cycle if there is no subsequent bus activity.
- Since asynchronous inputs are synchronized internally by the 80960CA, they have no required setup or hold times to be recognized and for proper operation. However, to guarantee recognition of the input at a particular edge of PCLK2:1, the setup times shown must be met. Asynchronous inputs must be active for at least two consecutive PCLK2:1 rising edges to be seen by the processor.
- These specifications are guaranteed by the processor.
- These specifications must be met by the system for proper operation of the processor.
- This timing is dependent upon the loading of PCLK2:1. Use the derating curves of **Section 4.5.3, Derating Curves** to adjust the timing for PCLK2:1 loading.
- In the 1-x input clock mode, the maximum input clock period is limited to 125 ns while the processor is operating. When the processor is in reset, the input clock may stop even in 1-x mode.
- When in the 1-x input clock mode, these specifications assume a stable input clock with a period variation of less than $\pm 0.1\%$ between adjacent cycles.
- In 2-x clock mode, \overline{RESET} is an asynchronous input which has no required setup and hold time for proper operation. However, to guarantee the device exits reset synchronized to a particular clock edge, the \overline{RESET} pin must meet setup and hold times to the falling edge of the CLKIN. (See Figure 21).
- In 1-x clock mode, \overline{RESET} is an asynchronous input which has no required setup and hold time for proper operation. However, to guarantee the device exits reset synchronized to a particular clock edge, the \overline{RESET} pin must meet setup and hold times to the rising edge of the CLKIN. (See Figure 22).
- The interrupt pins are synchronized internally by the 80960CA. They have no required setup or hold times for proper operation. These pins are sampled by the interrupt controller every other clock and must be active for at least three consecutive PCLK2:1 rising edges when asserting them asynchronously. To guarantee recognition at a particular clock edge, the setup and hold times shown must be met for two consecutive PCLK2:1 rising edges.

4.5.1 AC Test Conditions

The AC Specifications in Section 4.5 are tested with the 50 pF load shown in Figure 6. Figure 15 shows how timings vary with load capacitance.

Specifications are measured at the 1.5V crossing point, unless otherwise indicated. Input waveforms are assumed to have a rise and fall time of ≤ 2 ns from 0.8V to 2.0V. See **Section 4.5.2, AC Timing Waveforms** for AC spec definitions, test points and illustrations.

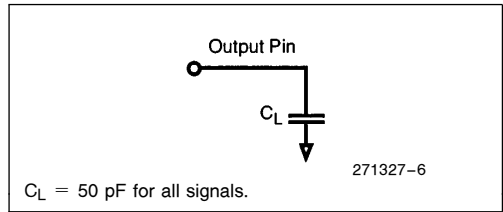

Figure 6. AC Test Load

4.5.2 AC Timing Waveforms

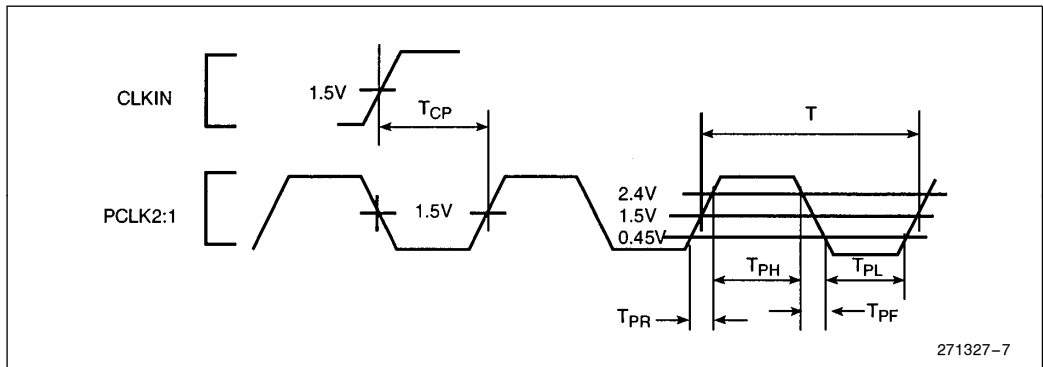

Figure 7. Input and Output Clock Waveforms

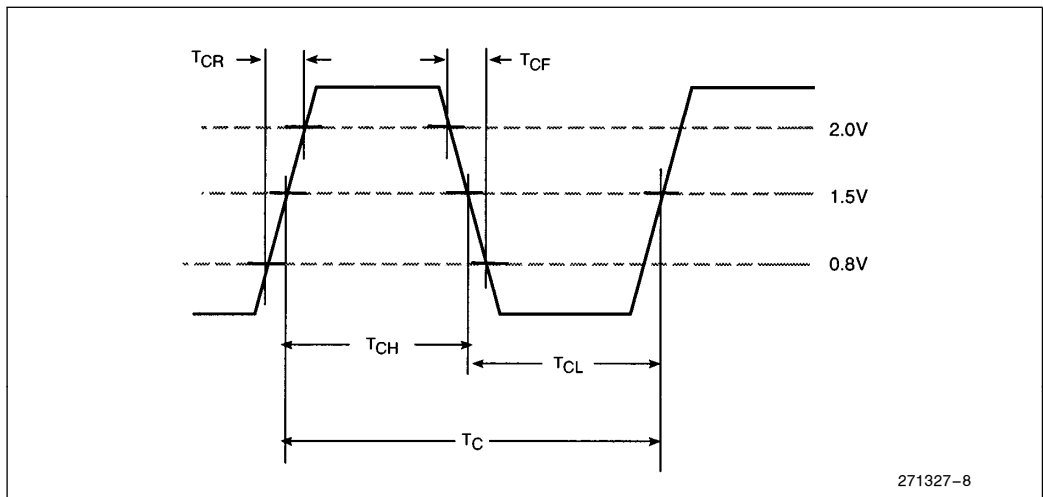

Figure 8. CLKIN Waveform

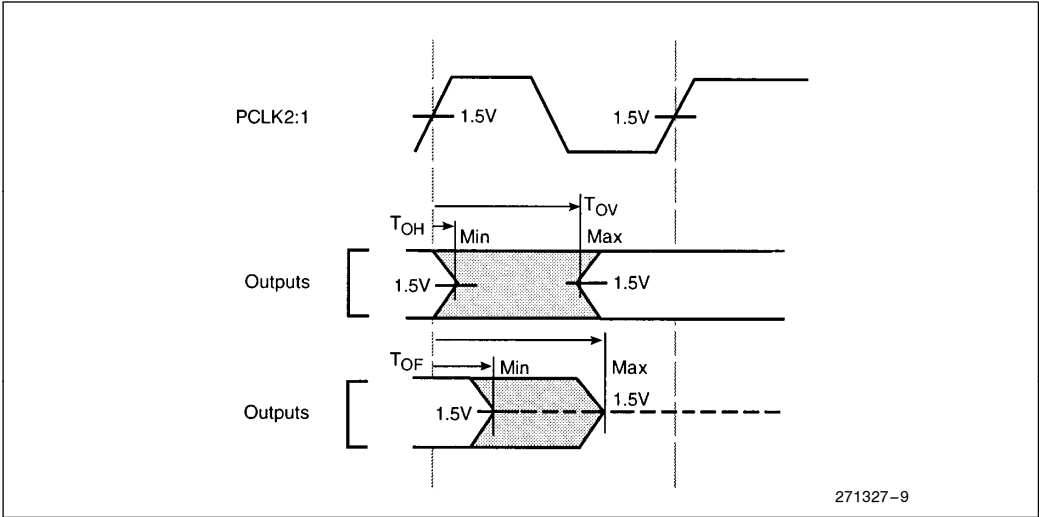

Figure 9. Output Delay and Float Waveform

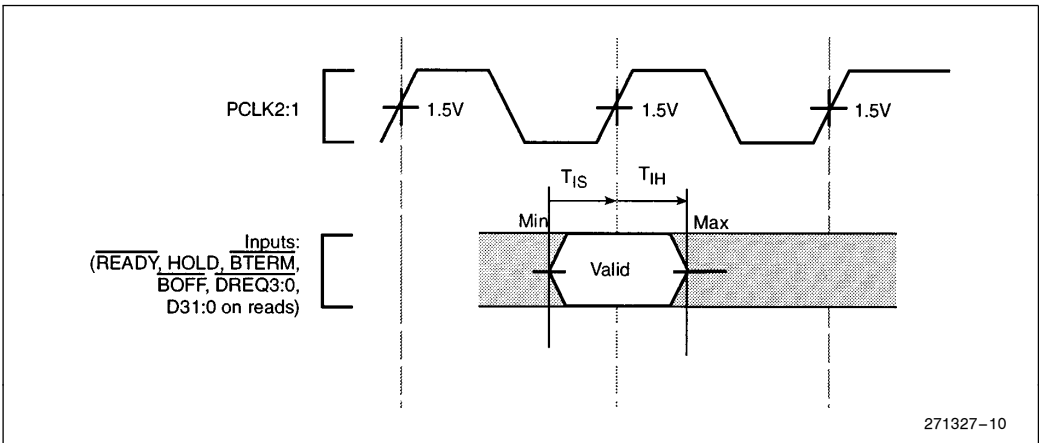

Figure 10. Input Setup and Hold Waveform

- T_{OV} T_{OH} OUTPUT DELAY—The maximum output delay is referred to as the Output Valid Delay (T_{OV}). The minimum output delay is referred to as the Output Hold (T_{OH}).
- T_{OF} OUTPUT FLOAT DELAY—The output float condition occurs when the maximum output current becomes less than I_{LO} in magnitude.
- T_{IS} T_{IH} INPUT SETUP AND HOLD—The input setup and hold requirements specify the sampling window during which synchronous inputs must be stable for correct processor operation.

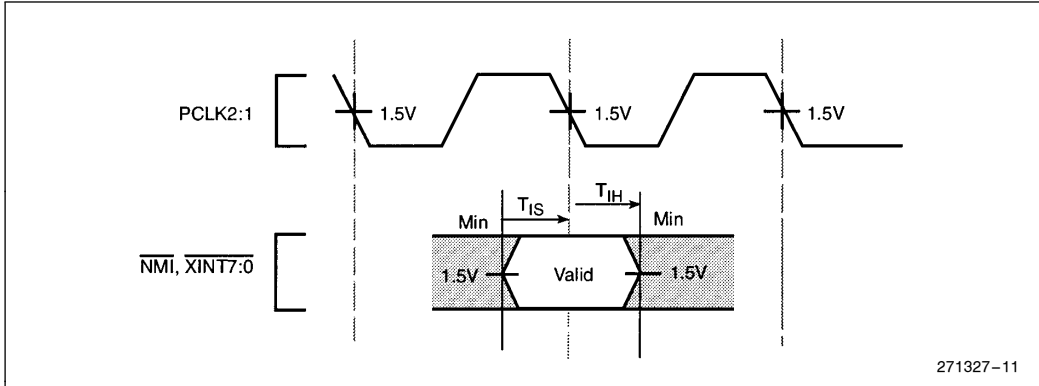

Figure 11. NMI, XINT7:0 Input Setup and Hold Waveform

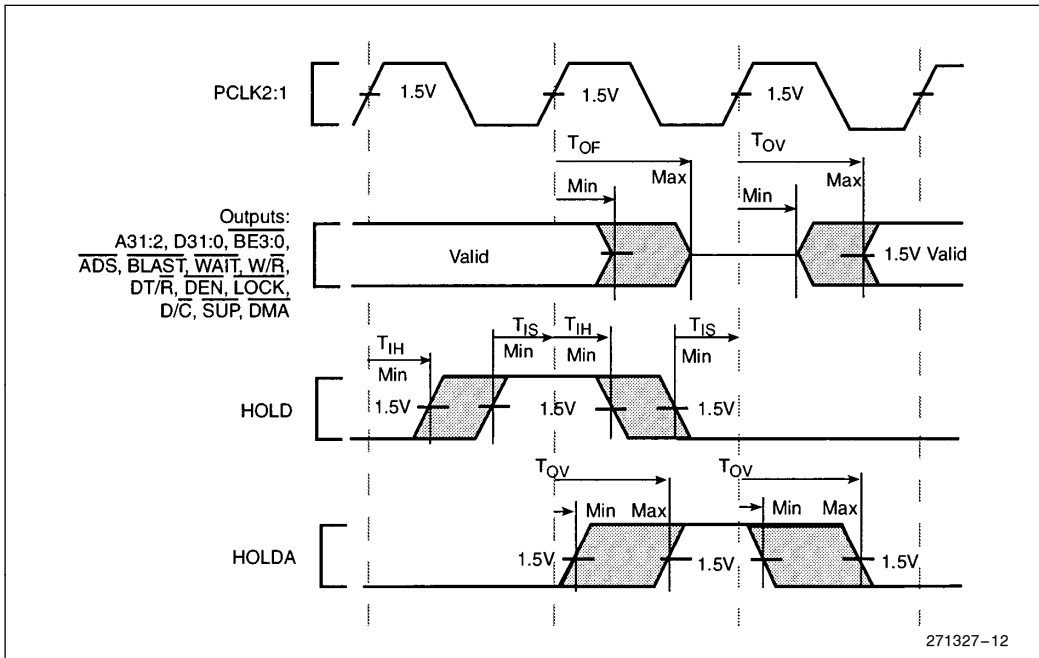

Figure 12. Hold Acknowledge Timings

- T_{OV} T_{OH} OUTPUT DELAY—The maximum output delay is referred to as the Output Valid Delay (T_{OV}). The minimum output delay is referred to as the Output Hold (T_{OH}).
- T_{OF} OUTPUT FLOAT DELAY—The output float condition occurs when the maximum output current becomes less than I_{LO} in magnitude.
- T_{IS} T_{IH} INPUT SETUP AND HOLD—The input setup and hold requirements specify the sampling window during which synchronous inputs must be stable for correct processor operation.

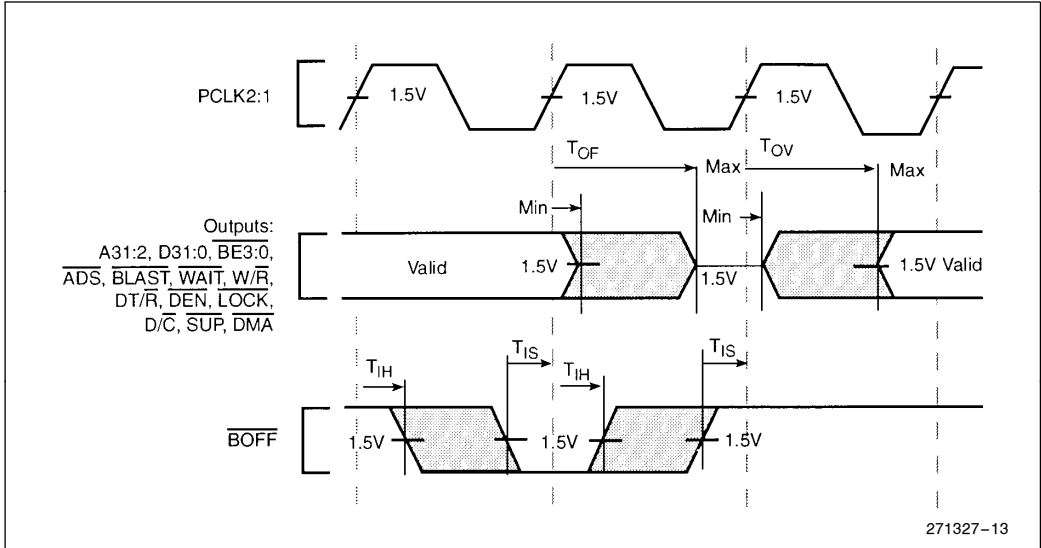

Figure 13. Bus Backoff BOFF Timings

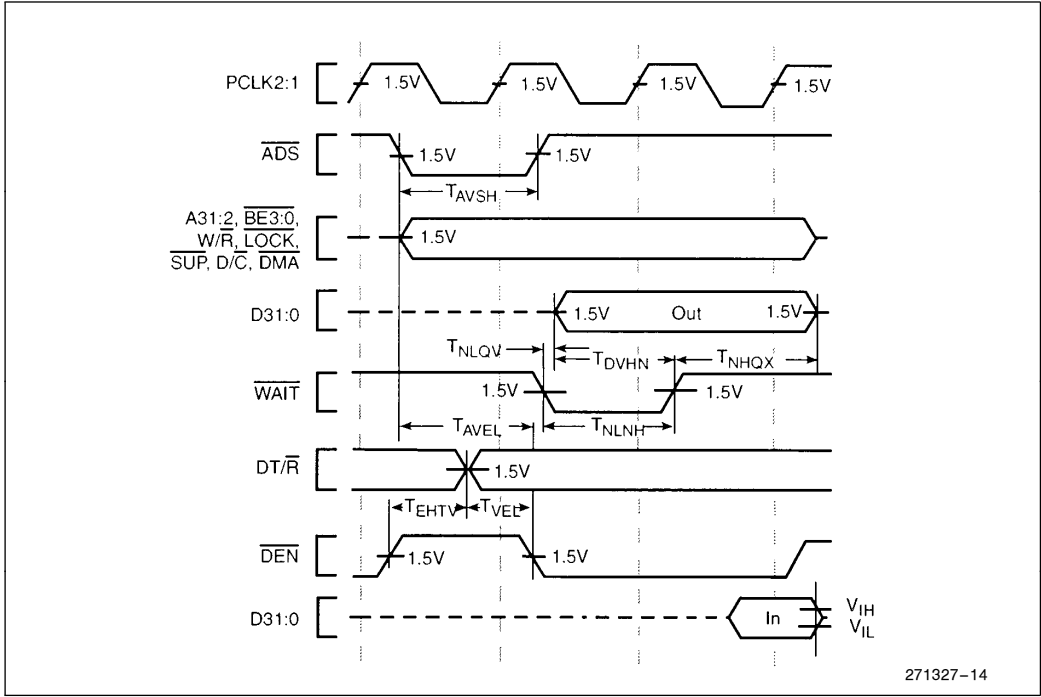

Figure 14. Relative Timings Waveforms

4.5.3 Derating Curves

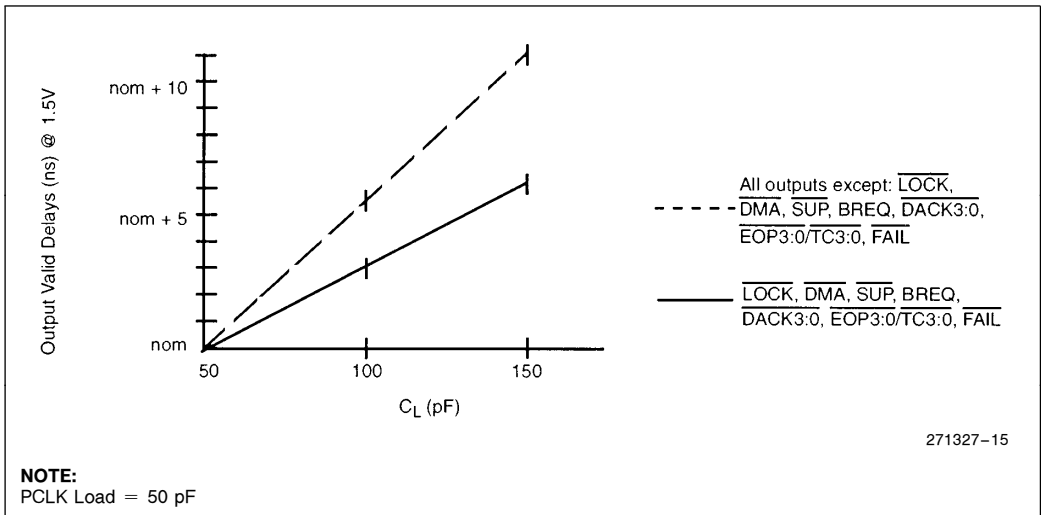

Figure 15. Output Delay or Hold vs Load Capacitance

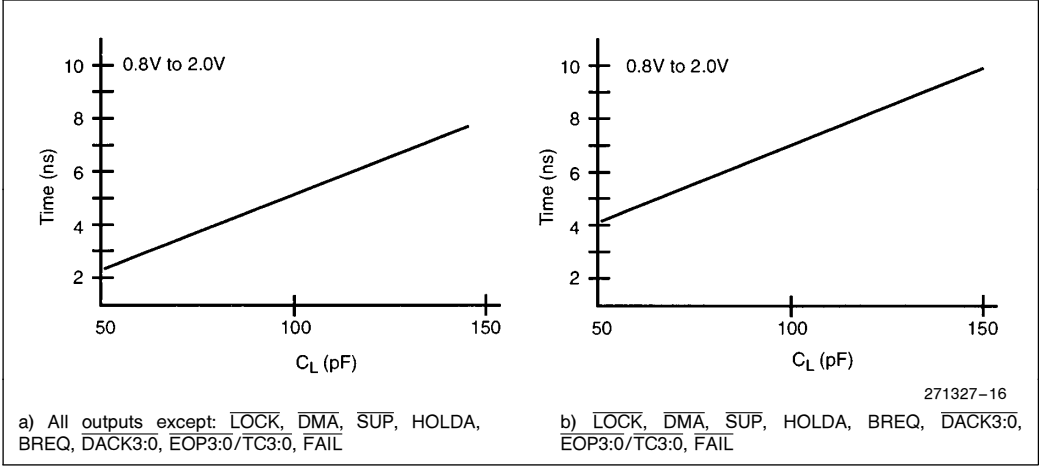

Figure 16. Rise and Fall Time Derating at Highest Operating Temperature and Minimum V_{CC}

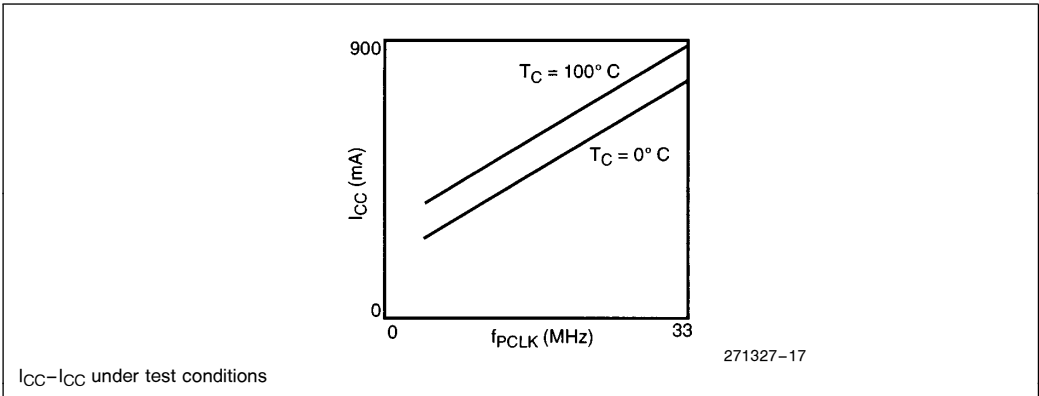

Figure 17. I_{CC} vs Frequency and Temperature

5.0 RESET, BACKOFF AND HOLD ACKNOWLEDGE

Table 15 lists the condition of each processor output pin while $\overline{\text{RESET}}$ is asserted (low).

Table 15. Reset Conditions

Pins	State During Reset (HOLDA Inactive) ¹
A31:2	Floating
D31:0	Floating
$\overline{\text{BE3:0}}$	Driven high (Inactive)
$\text{W}/\overline{\text{R}}$	Driven low (Read)
$\overline{\text{ADS}}$	Driven high (Inactive)
$\overline{\text{WAIT}}$	Driven high (Inactive)
$\overline{\text{BLAST}}$	Driven low (Active)
$\text{DT}/\overline{\text{R}}$	Driven low (Receive)
$\overline{\text{DEN}}$	Driven high (Inactive)
$\overline{\text{LOCK}}$	Driven high (inactive)
BREQ	Driven low (Inactive)
$\text{D}/\overline{\text{C}}$	Floating
$\overline{\text{DMA}}$	Floating
$\overline{\text{SUP}}$	Floating
FAIL	Driven low (Active)
$\overline{\text{DACK3:0}}$	Driven high (Inactive)
$\overline{\text{EOP3:0}}/\overline{\text{TC3:0}}$	Floating (Set to input mode)

NOTES:

1. With regard to bus output pin state only, the Hold Acknowledge state takes precedence over the reset state. Although asserting the $\overline{\text{RESET}}$ pin will internally reset the processor, the processor's bus output pins will not enter the reset state if it has granted Hold Acknowledge to a previous HOLD request (HOLDA is active). Furthermore, the processor will grant new HOLD requests and enter the Hold Acknowledge state even while in reset.

For example, if HOLDA is inactive and the processor is in the reset state, then HOLD is asserted, the processor's bus pins enter the Hold Acknowledge state and HOLDA is granted. The processor will not be able to perform memory accesses until the HOLD request is removed, even if the $\overline{\text{RESET}}$ pin is brought high. This operation is provided to simplify boot-up synchronization among multiple processors sharing the same bus.

Table 16 lists the condition of each processor output pin while HOLDA is asserted (low).

Table 16. Hold Acknowledge and Backoff Conditions

Pins	State During HOLDA
A31:2	Floating
D31:0	Floating
$\overline{\text{BE3:0}}$	Floating
$\text{W}/\overline{\text{R}}$	Floating
$\overline{\text{ADS}}$	Floating
$\overline{\text{WAIT}}$	Floating
$\overline{\text{BLAST}}$	Floating
$\text{DT}/\overline{\text{R}}$	Floating
$\overline{\text{DEN}}$	Floating
$\overline{\text{LOCK}}$	Floating
BREQ	Driven (High or low)
$\text{D}/\overline{\text{C}}$	Floating
$\overline{\text{DMA}}$	Floating
$\overline{\text{SUP}}$	Floating
FAIL	Driven high (Inactive)
$\overline{\text{DACK3:0}}$	Driven high (Inactive)
$\overline{\text{EOP3:0}}/\overline{\text{TC3:0}}$	Driven (If output)

6.0 BUS WAVEFORMS

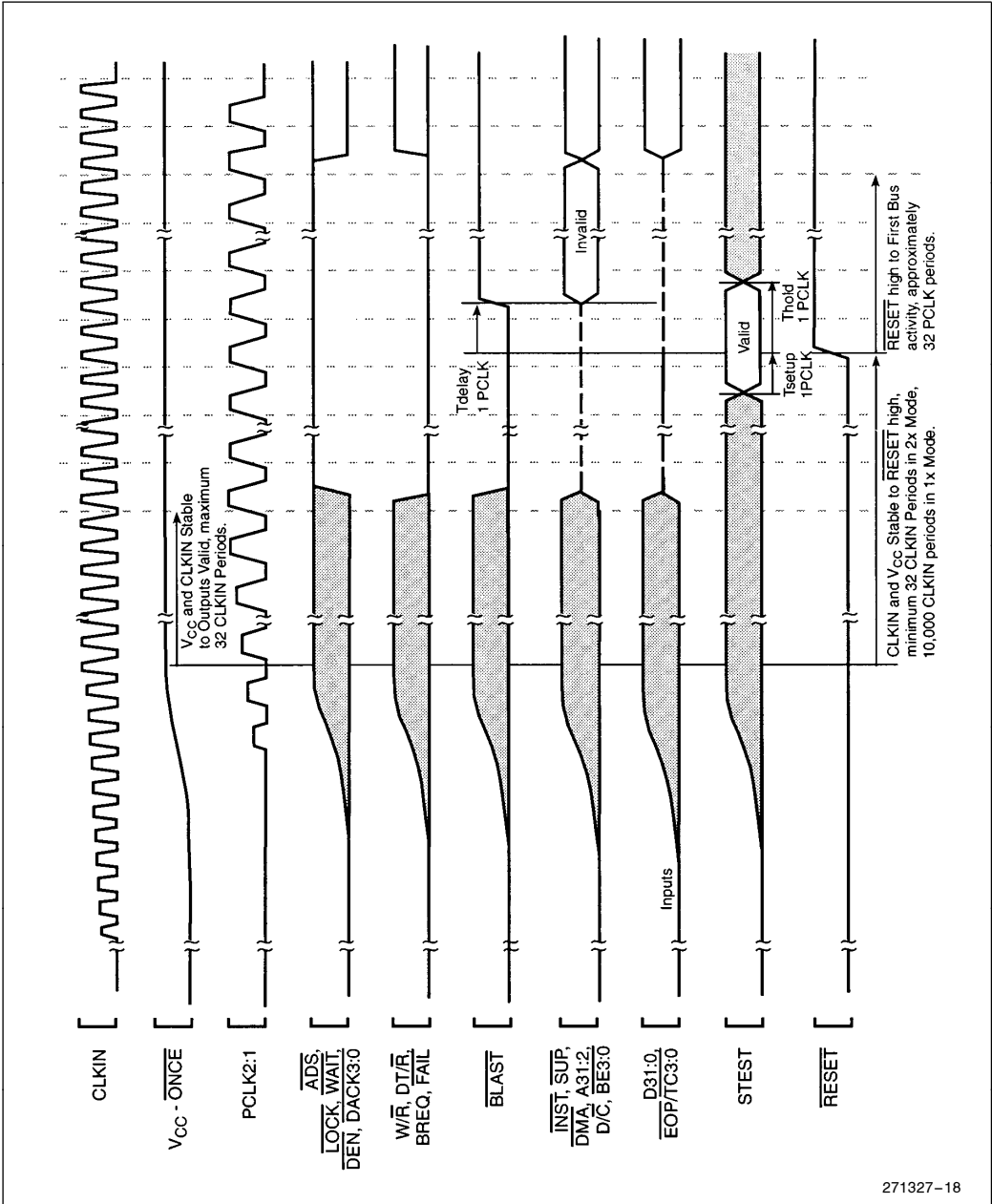

Figure 18. Cold Reset Waveform

271327-18

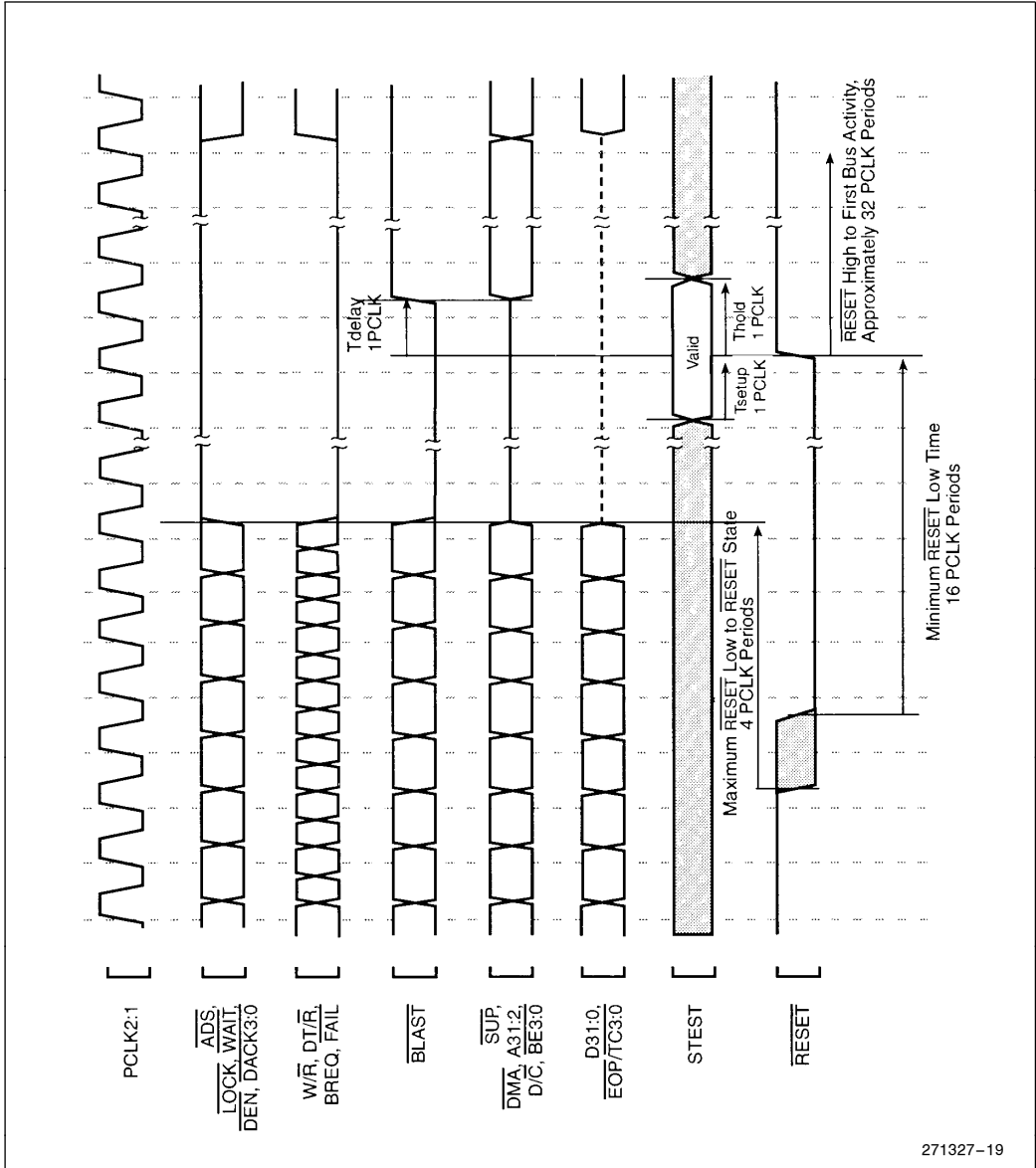

Figure 19. Warm Reset Waveform

271327-19

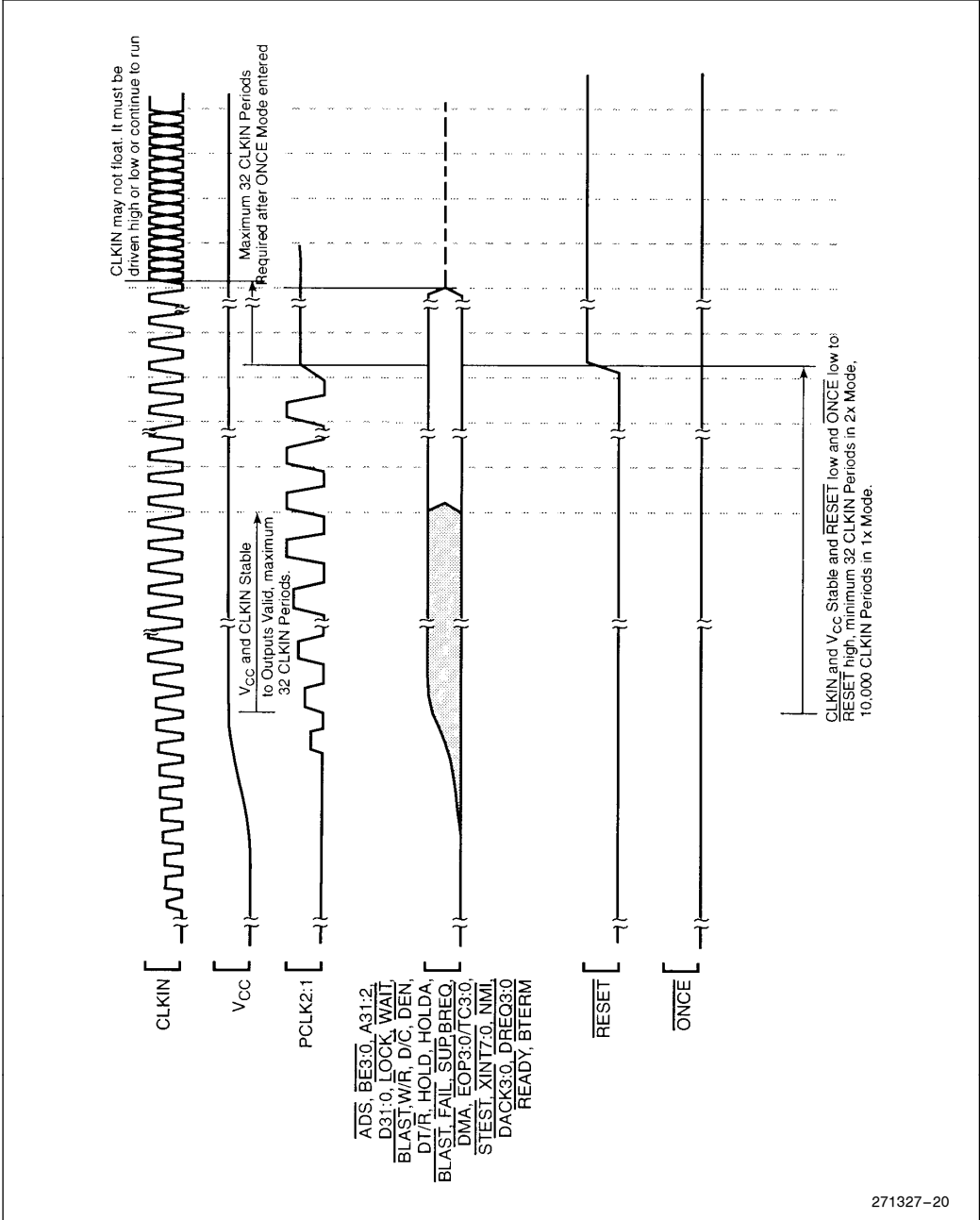

Figure 20. Entering the ONCE State

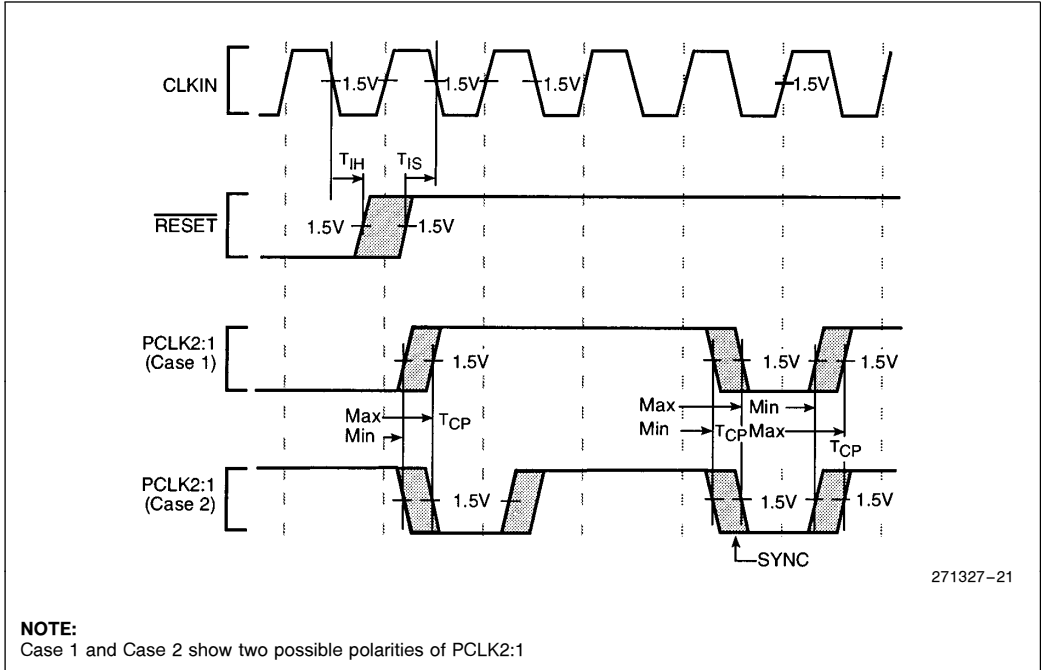

Figure 21. Clock Synchronization in the 2-x Clock Mode

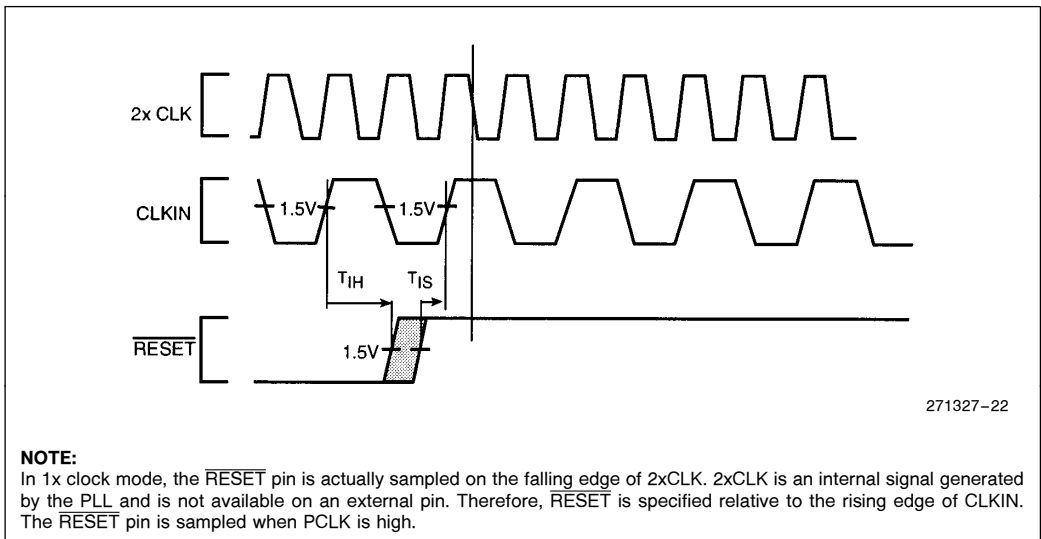

Figure 22. Clock Synchronization in the 1-x Clock Mode

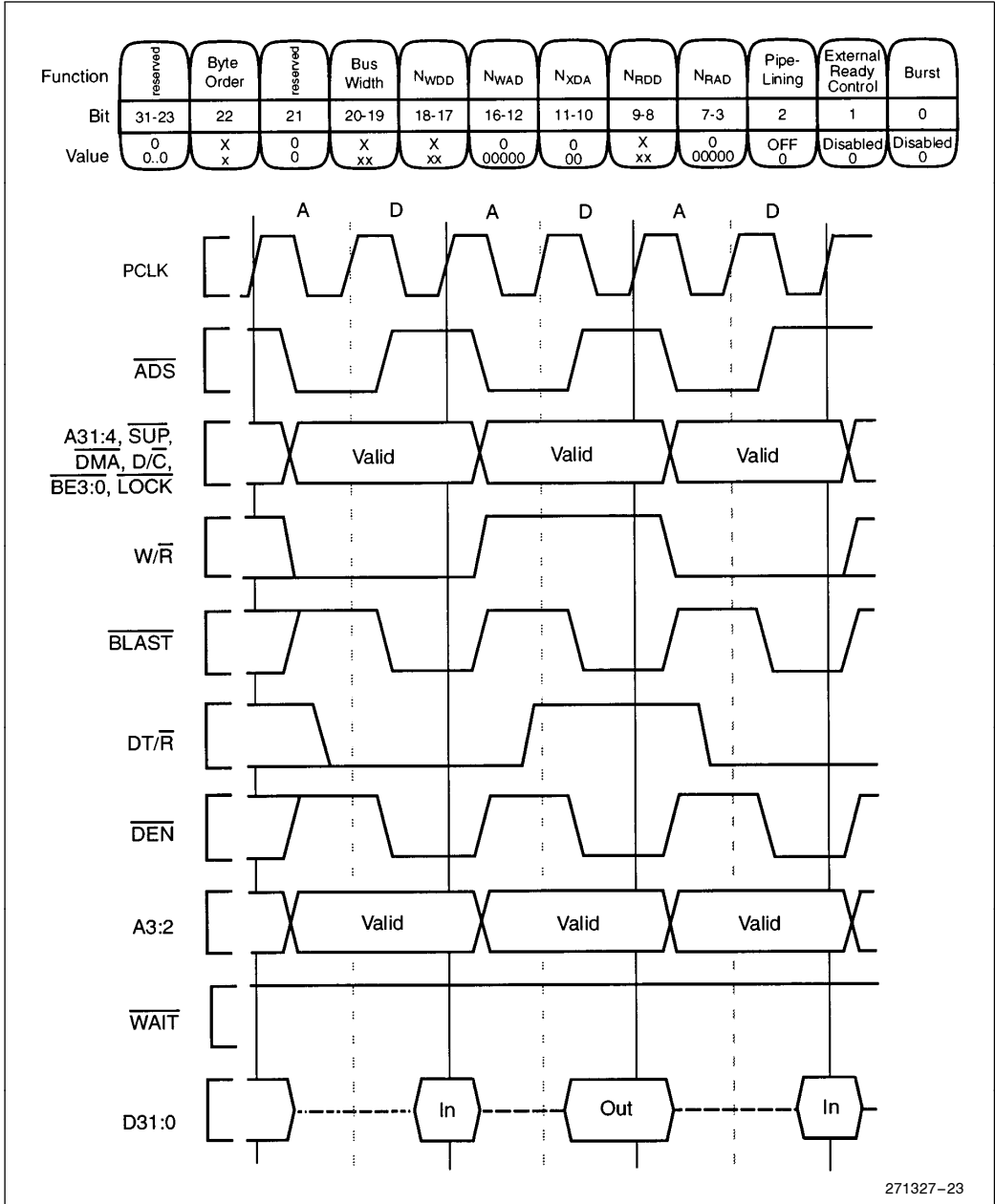
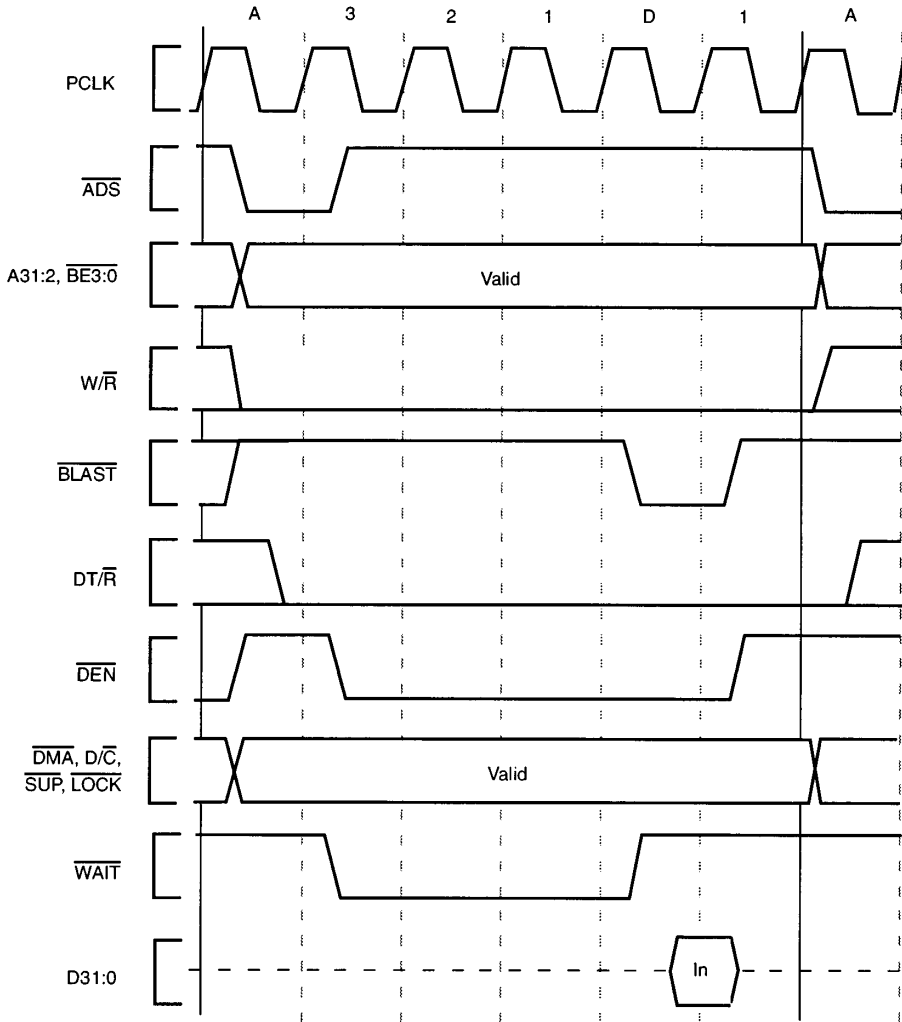

Figure 23. Non-Burst, Non-Pipelined Requests Without Wait States

Function	reserved	Byte Order	reserved	Bus Width	N _{WDD}	N _{WAD}	N _{XDA}	N _{RDD}	N _{RAD}	Pipe-Lining	External Ready Control	Burst
Bit	31-23	22	21	20-19	18-17	16-12	11-10	9-8	7-3	2	1	0
Value	0 0..0	X x	0 0	X xx	X xx	X xxxxx	1 01	X xx	3 00011	OFF 0	Disabled 0	Disabled 0



271327-24

Figure 24. Non-Burst, Non-Pipelined Read Request With Wait States

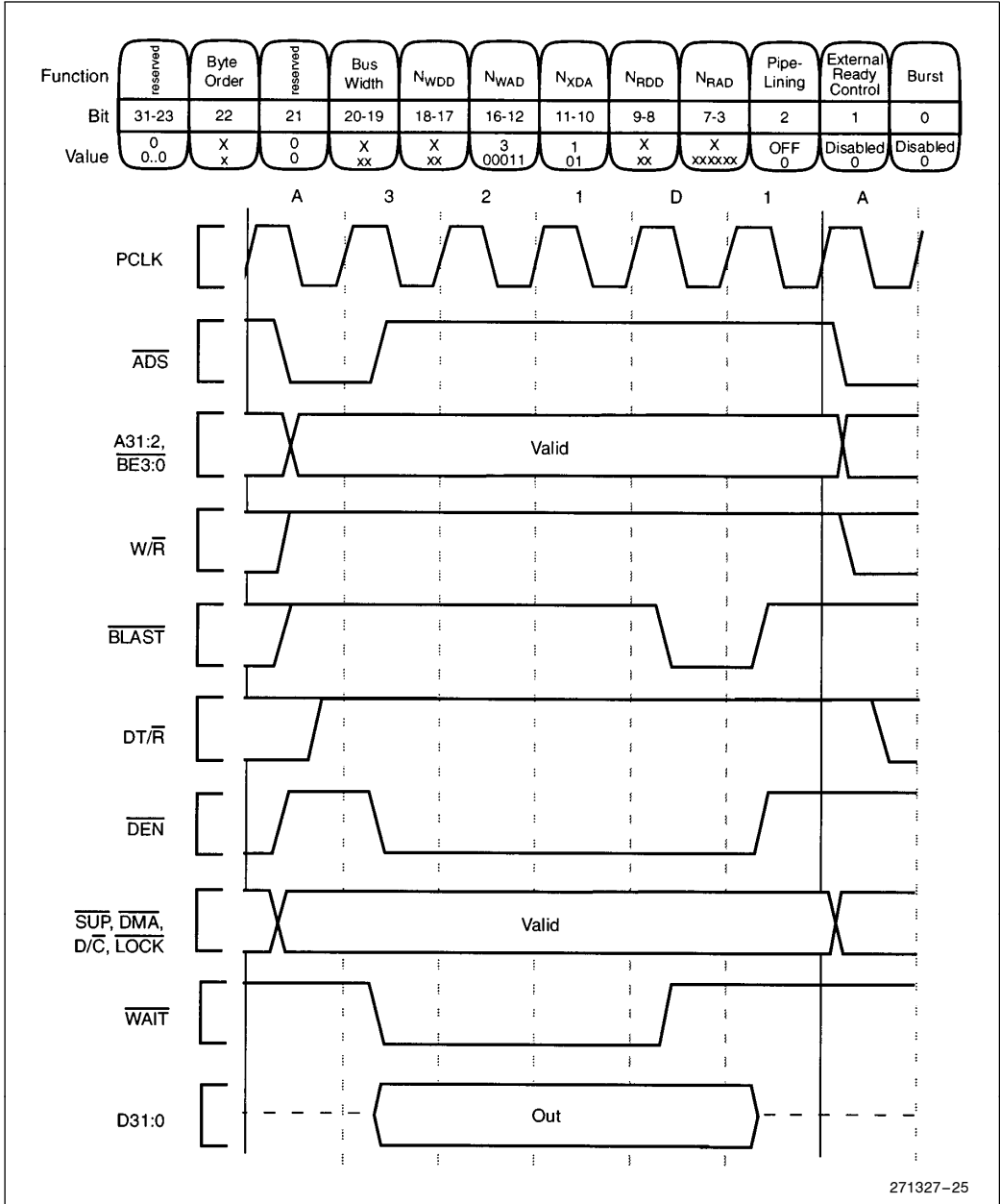

Figure 25. Non-Burst, Non-Pipelined Write Request With Wait States

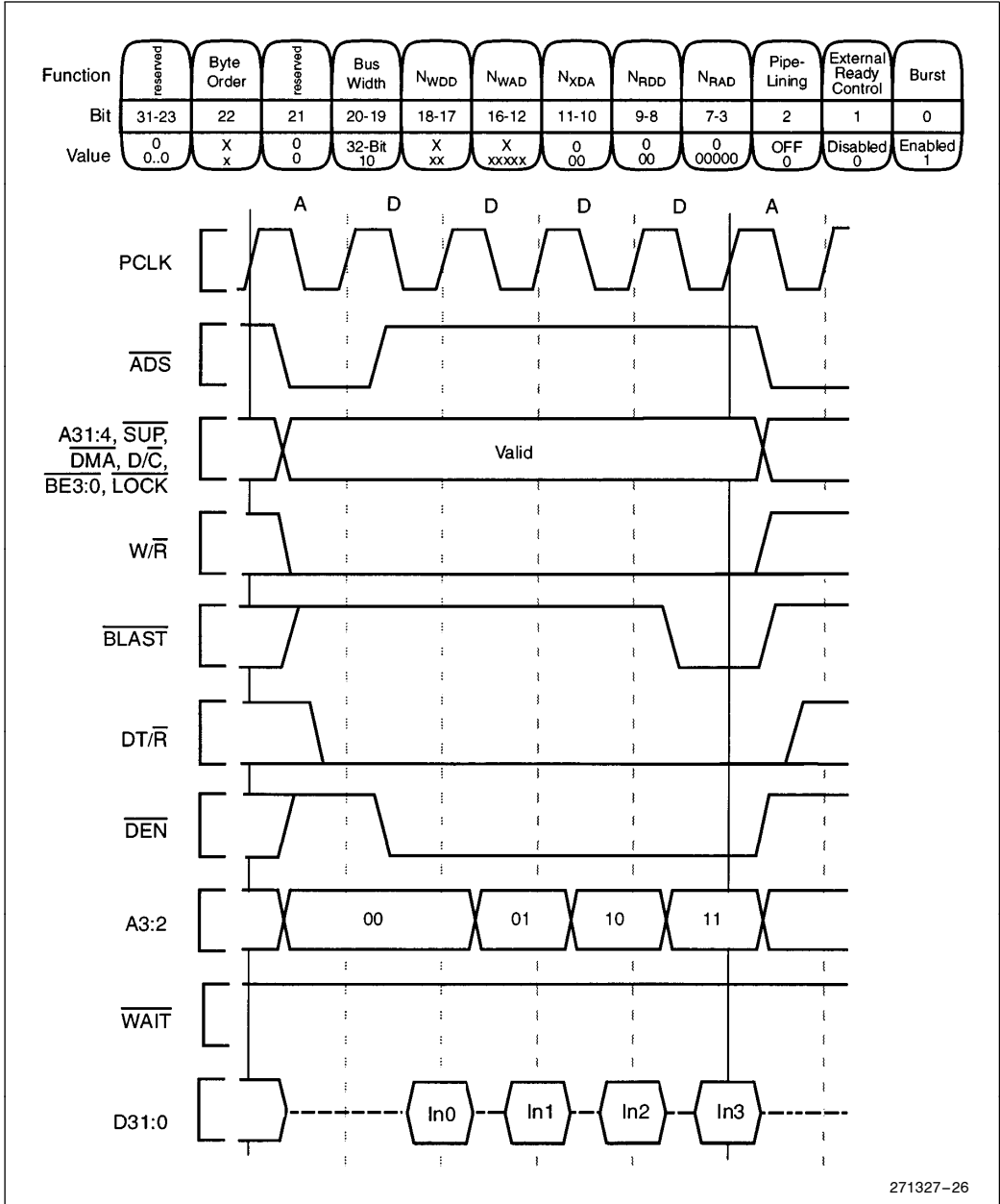
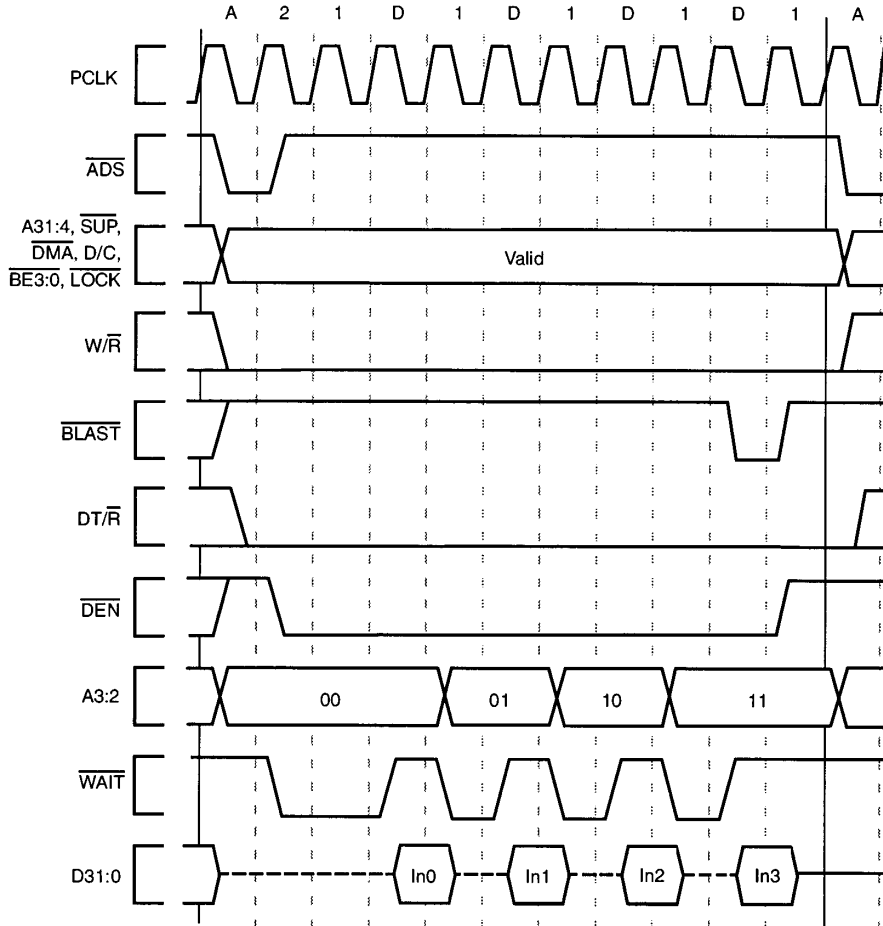

Figure 26. Burst, Non-Pipelined Read Request Without Wait States, 32-Bit Bus

Function	reserved	Byte Order	reserved	Bus Width	N _{WDD}	N _{WAD}	N _{XDA}	N _{RDD}	N _{RAD}	Pipe-Lining	External Ready Control	Burst
Bit	31-23	22	21	20-19	18-17	16-12	11-10	9-8	7-3	2	1	0
Value	0 0..0	X X	0 0	32-bit 10	X XX	X XXXXX	1 01	1 01	2 00010	OFF 0	Disabled 0	Enabled 1



271327-27

Figure 27. Burst, Non-Pipelined Read Request With Wait States, 32-Bit Bus

Function	reserved	Byte Order	reserved	Bus Width	N _{WDD}	N _{WAD}	N _{XDA}	N _{RDD}	N _{RAD}	Pipe-Lining	External Ready Control	Burst
Bit	31-23	22	21	20-19	18-17	16-12	11-10	9-8	7-3	2	1	0
Value	0 0..0	X x	0 0	32-bit 10	0 00	0 00000	0 00	X xx	X xxxxx	OFF 0	Disabled 0	Enabled 1

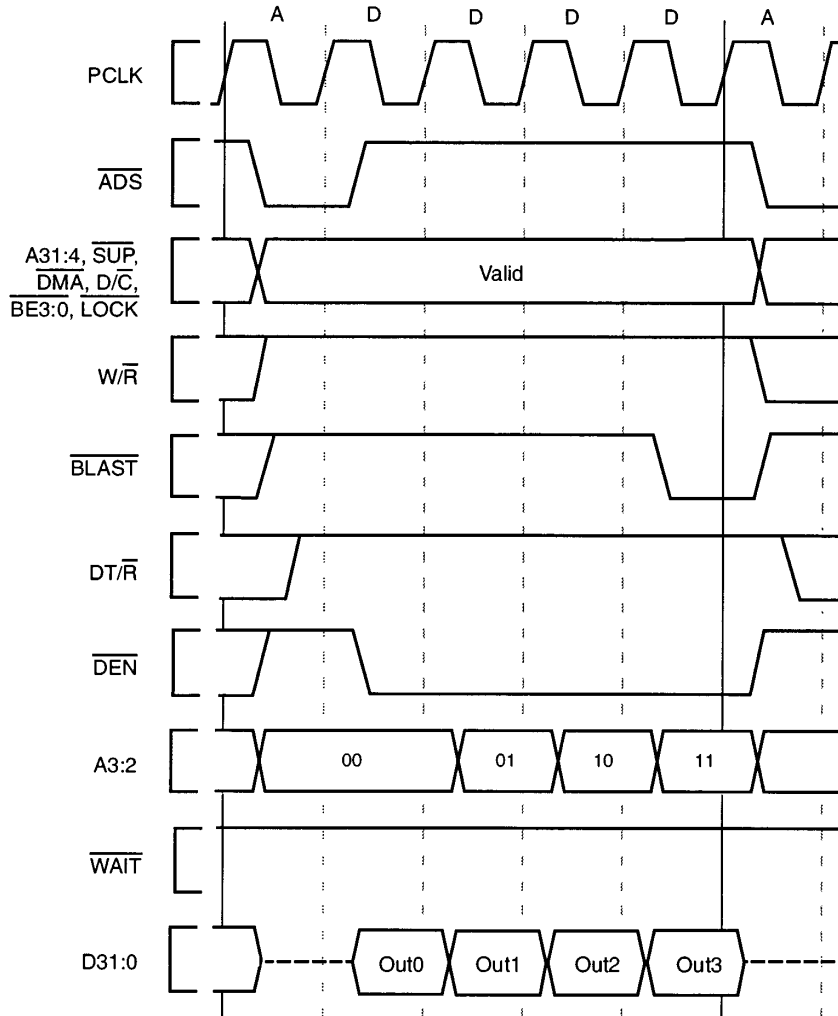

271327-28

Figure 28. Burst, Non-Pipelined Write Request Without Wait States, 32-Bit Bus

Function	reserved	Byte Order	reserved	Bus Width	NWDD	NWAD	NxDA	NRDD	NRAD	Pipe-Lining	External Ready Control	Burst
Bit	31-23	22	21	20-19	18-17	16-12	11-10	9-8	7-3	2	1	0
Value	0 0..0	X x	0 0	32-bit 10	1 01	2 00010	1 01	X xx	X xxxxx	OFF 0	Disabled 0	Enabled 1

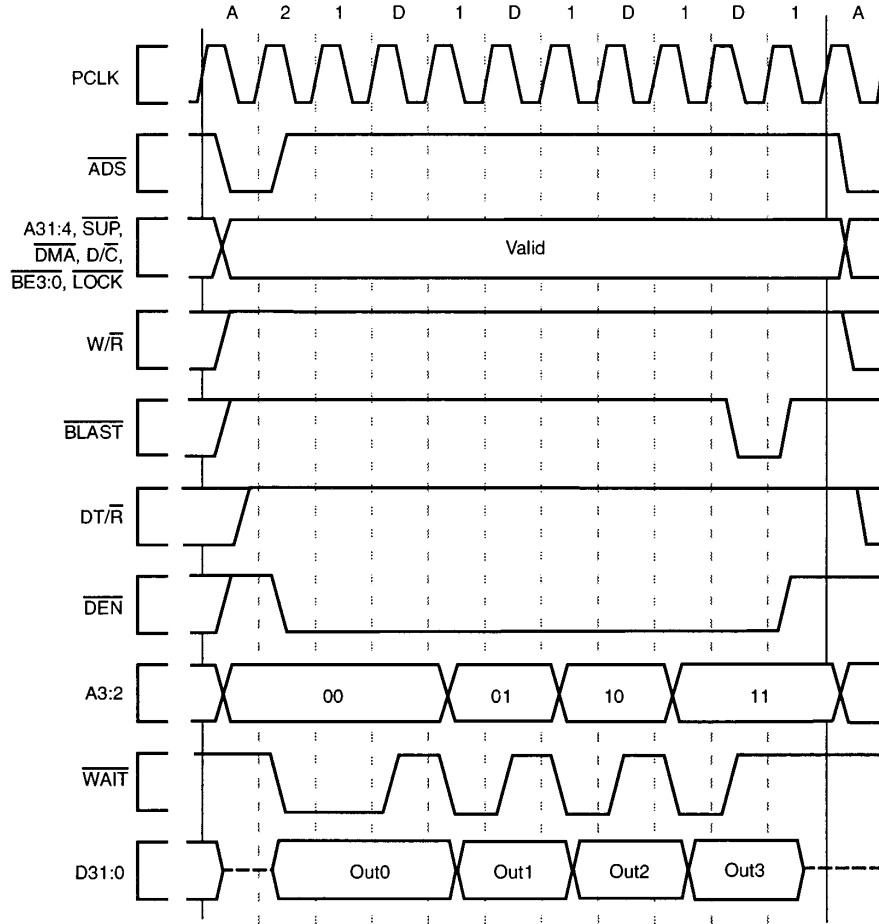

271327-29

Figure 29. Burst, Non-Pipelined Write Request With Wait States, 32-Bit Bus

Function	reserved	Byte Order	reserved	Bus Width	NWDD	NWAD	NXDA	NRDD	NRAD	Pipe-Lining	External Ready Control	Burst
Bit	31-23	22	21	20-19	18-17	16-12	11-10	9-8	7-3	2	1	0
Value	0 0..0	X x	0 0	16-bit 01	X xx	X xxxxx	1 01	1 01	2 00010	OFF 0	Disabled 0	Enabled 1

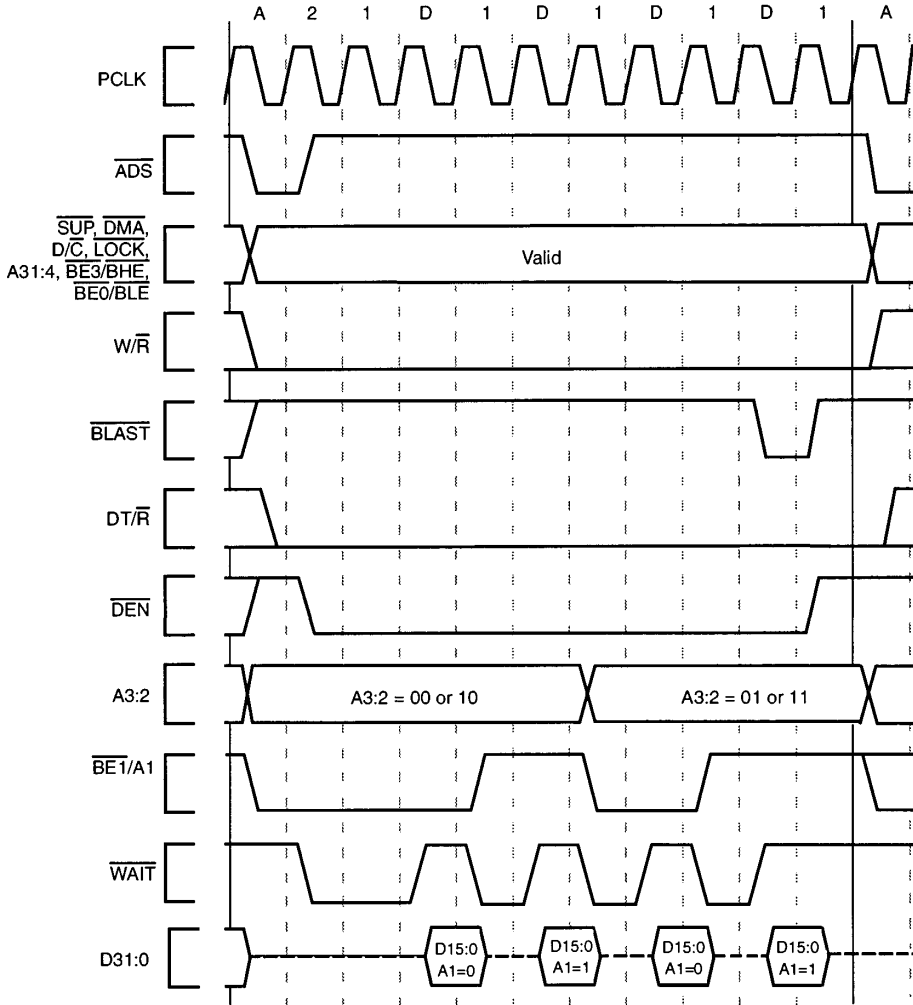

271327-30

Figure 30. Burst, Non-Pipelined Read Request With Wait States, 16-Bit Bus

Function	reserved	Byte Order	reserved	Bus Width	N _{WDD}	N _{WAD}	N _{XDA}	N _{RDD}	N _{RAD}	Pipe-Lining	External Ready Control	Burst
Bit	31-23	22	21	20-19	18-17	16-12	11-10	9-8	7-3	2	1	0
Value	0 0..0	X x	0 0	8-bit 00	X xx	X xxxxx	1 01	1 01	2 00010	OFF 0	Disabled 0	Enabled 1

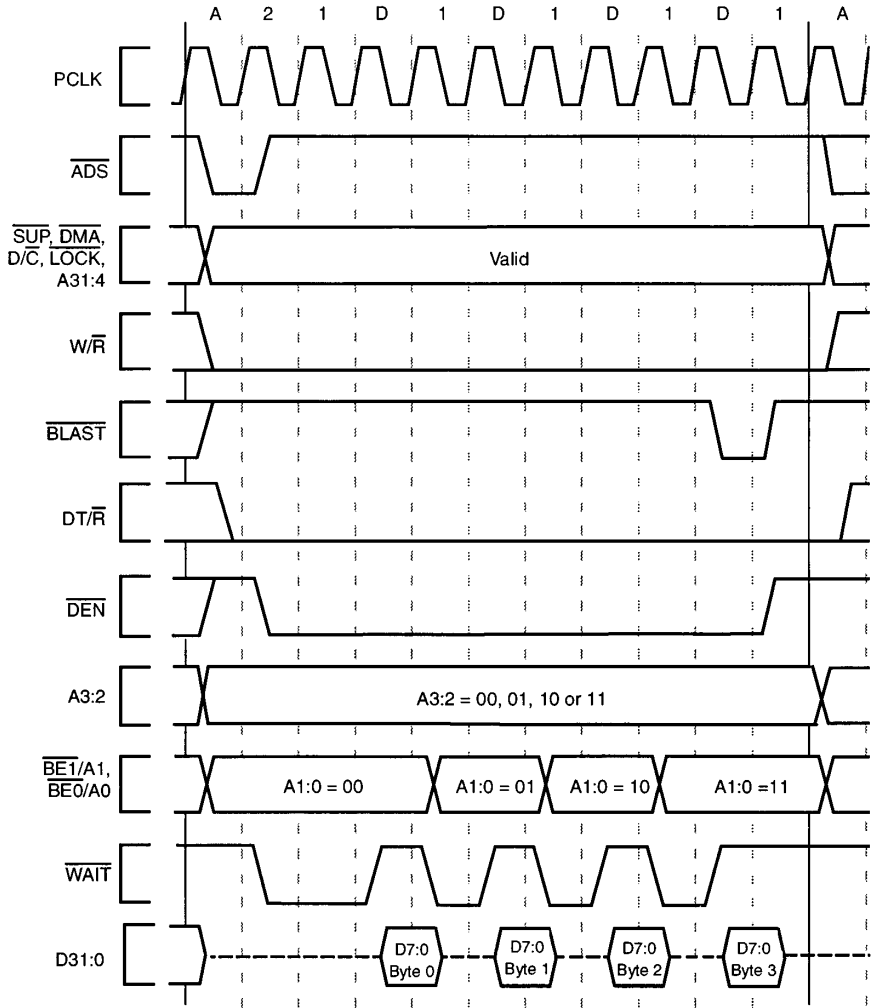

271327-31

Figure 31. Burst, Non-Pipelined Read Request With Wait States, 8-Bit Bus

Function	reserved	Byte Order	reserved	Bus Width	NWDD	NWAD	NXDA	NRDD	NRAD	Pipe-Lining	External Ready Control	Burst
Bit	31-23	22	21	20-19	18-17	16-12	11-10	9-8	7-3	2	1	0
Value	0 0..0	X x	0 0	X xx	X xx	X xxxx	X xx	X xx	0 00000	ON 1	X x	Disabled 0

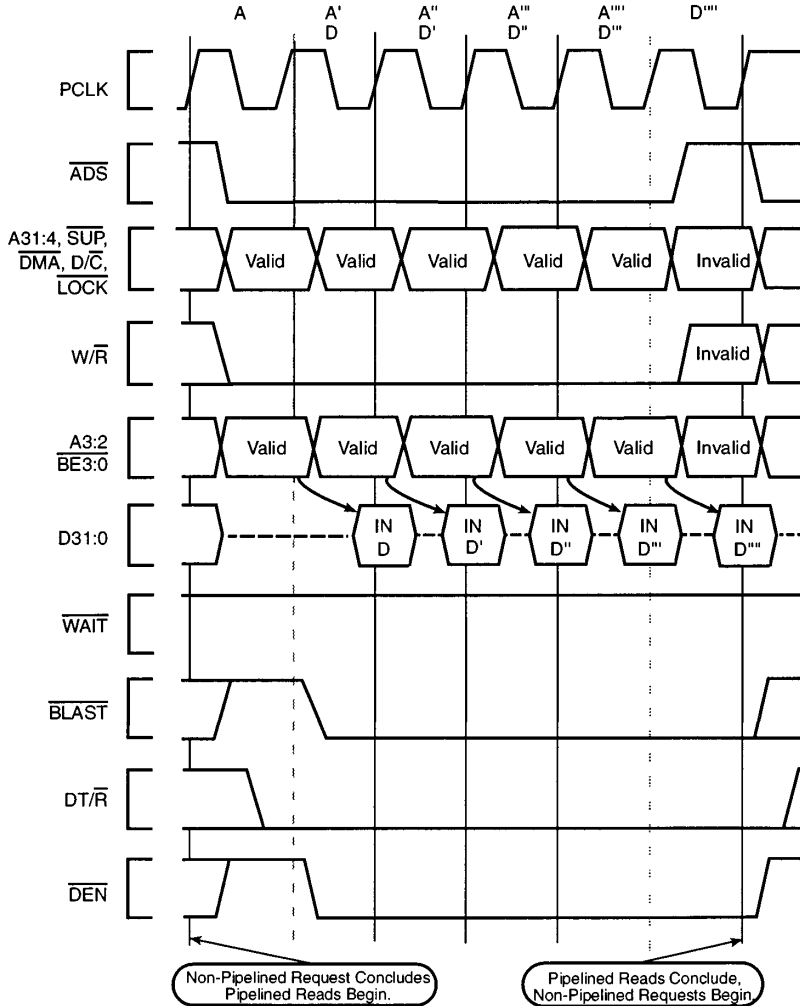

271327-32

Figure 32. Non-Burst, Pipelined Read Request Without Wait States, 32-Bit Bus

Function	reserved	Byte Order	reserved	Bus Width	NWDD	NWAD	NXDA	NRDD	NRAD	Pipe-Lining	External Ready Control	Burst
Bit	31-23	22	21	20-19	18-17	16-12	11-10	9-8	7-3	2	1	0
Value	0 0..0	X x	0 0	X xx	X xx	X xxxxx	X xx	X xx	1 00001	ON 1	X x	Disabled 1

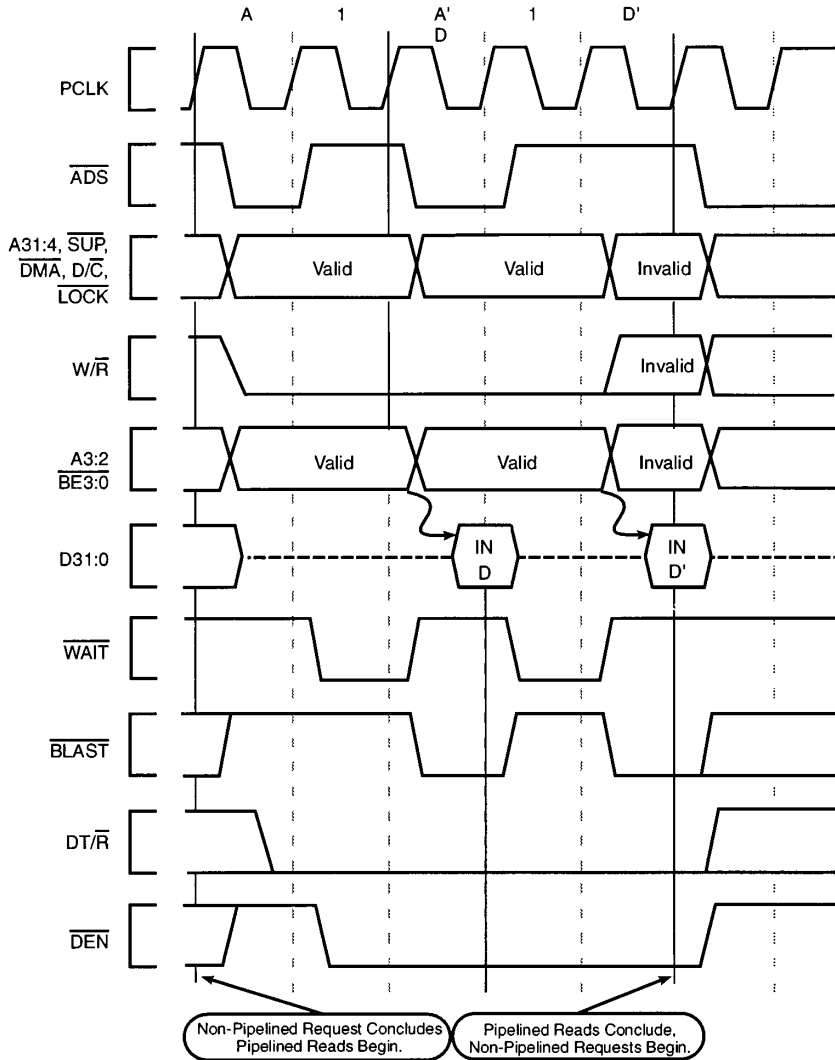

271327-33

Figure 33. Non-Burst, Pipelined Read Request With Wait States, 32-Bit Bus

Function	reserved	Byte Order	reserved	Bus Width	N _{WDD}	N _{WAD}	N _{XDA}	N _{RDD}	N _{RAD}	Pipe-Lining	External Ready Control	Burst
Bit	31-23	22	21	20-19	18-17	16-12	11-10	9-8	7-3	2	1	0
Value	0 0..0	X x	0 0	32-bit 10	X xx	X xxxxx	X xx	0 00	0 00000	ON 1	Disabled 0	Enabled 1

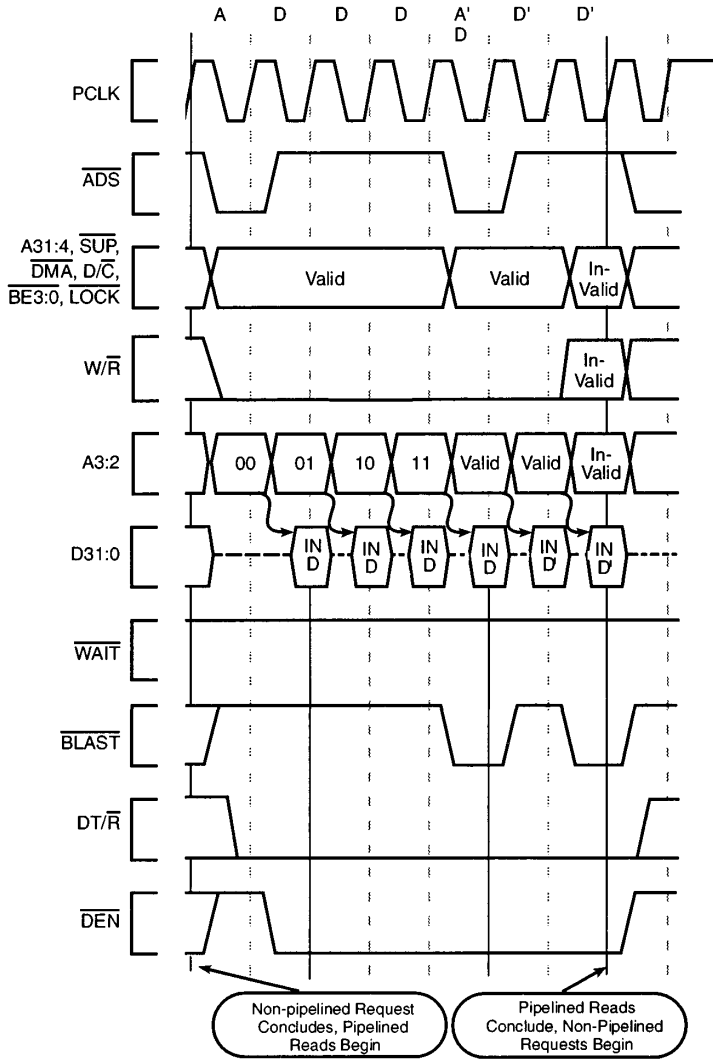

271327-34

Figure 34. Burst, Pipelined Read Request Without Wait States, 32-Bit Bus

Function	reserved	Byte Order	reserved	Bus Width	N _{WDD}	N _{WAD}	N _{XDA}	N _{RDD}	N _{RAD}	Pipe-Lining	External Ready Control	Burst
Bit	31-23	22	21	20-19	18-17	16-12	11-10	9-8	7-3	2	1	0
Value	0 0..0	X X	0 0	32-bit 10	X XX	X XXXXX	X XX	1 01	2 00010	ON 1	Disabled 0	Enabled 1

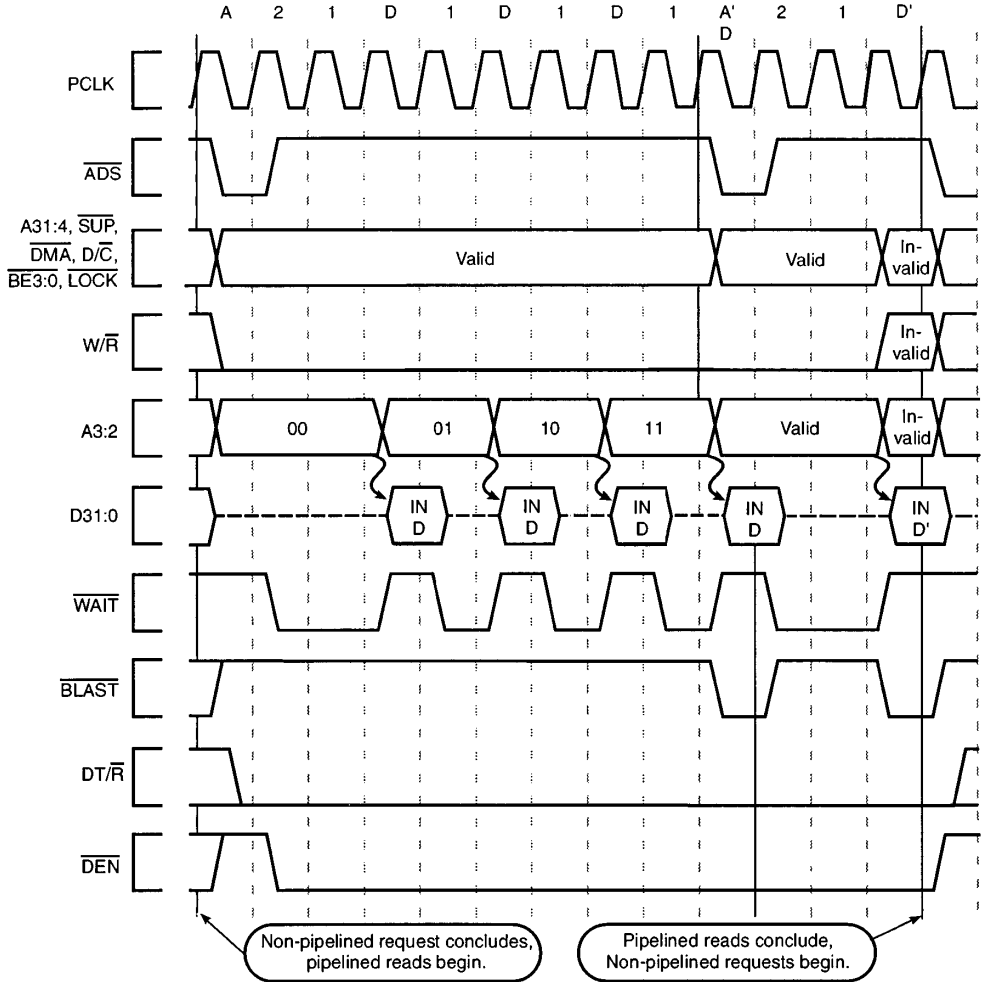

271327-35

Figure 35. Burst, Pipelined Read Request With Wait States, 32-Bit Bus

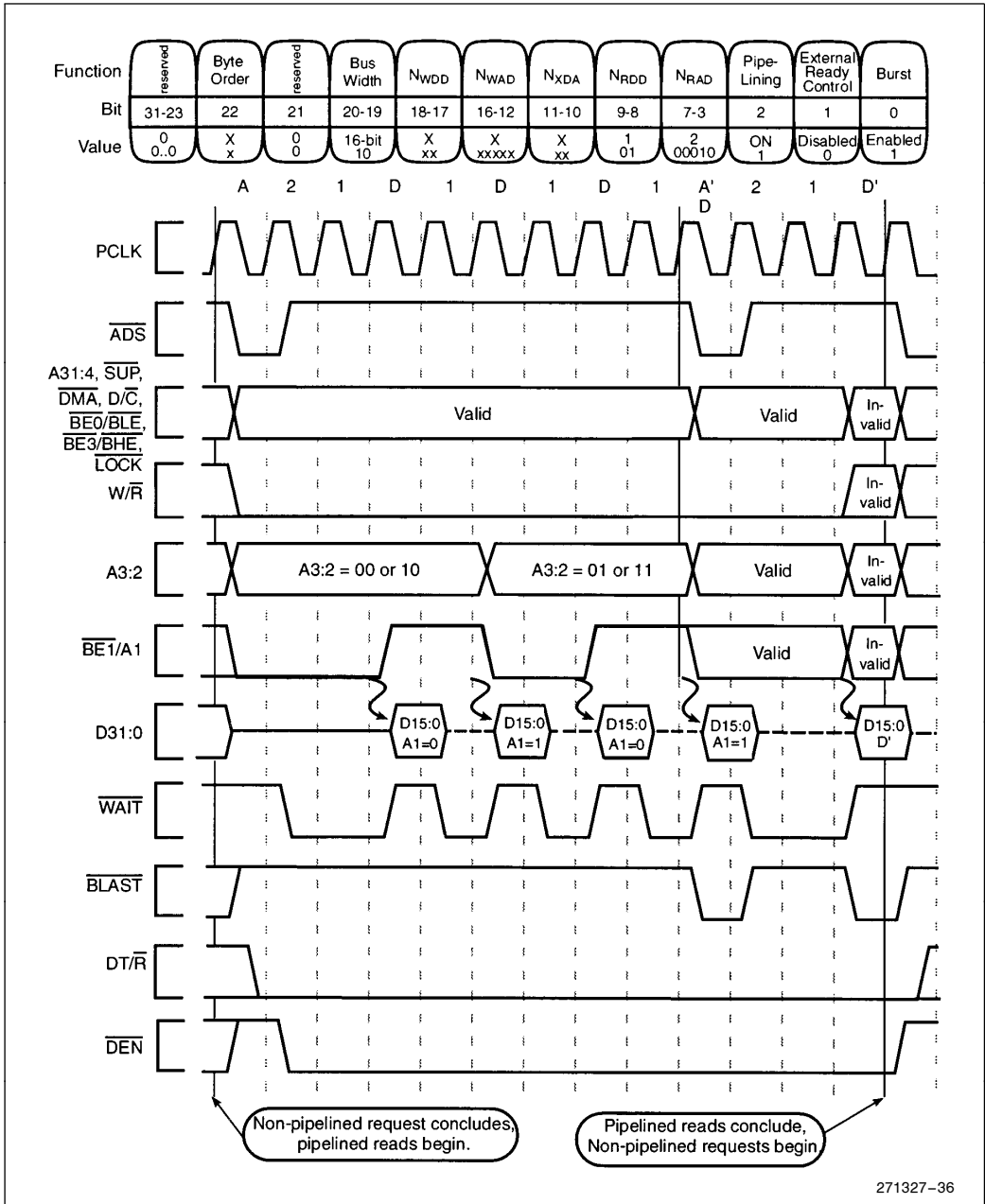

Figure 36. Burst, Pipelined Read Request With Wait States, 16-Bit Bus

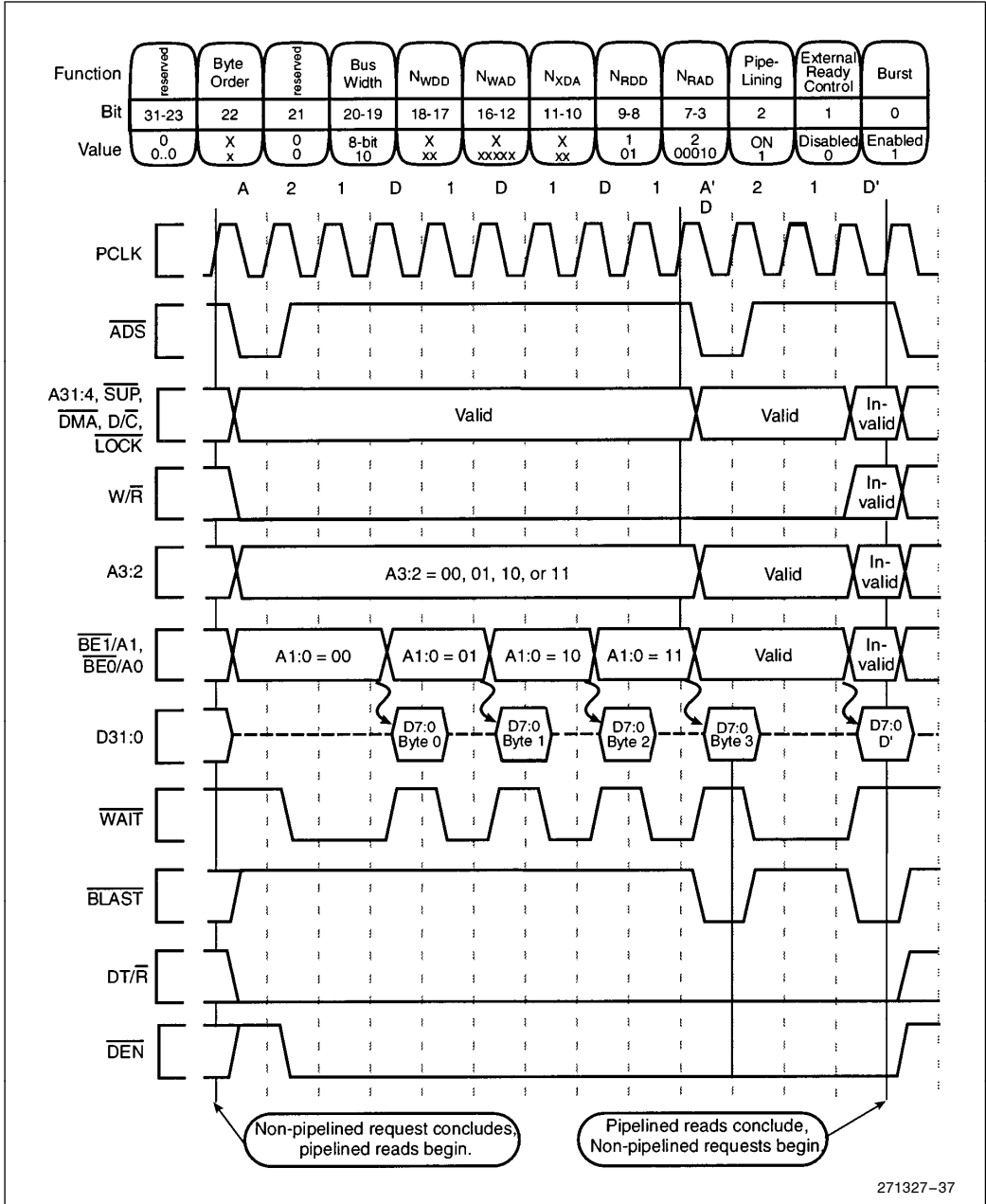

Figure 37. Burst, Pipelined Read Request With Wait States, 8-Bit Bus

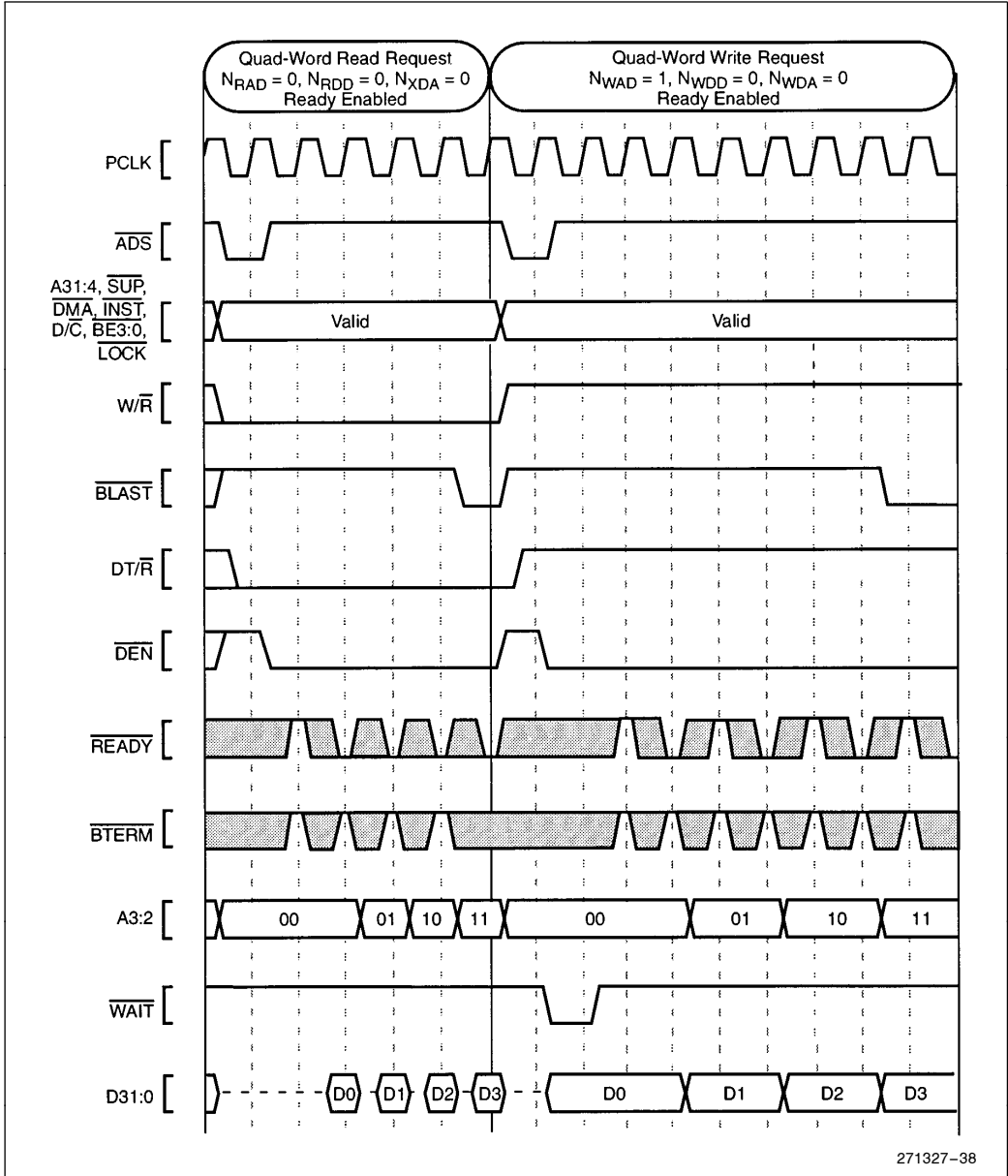
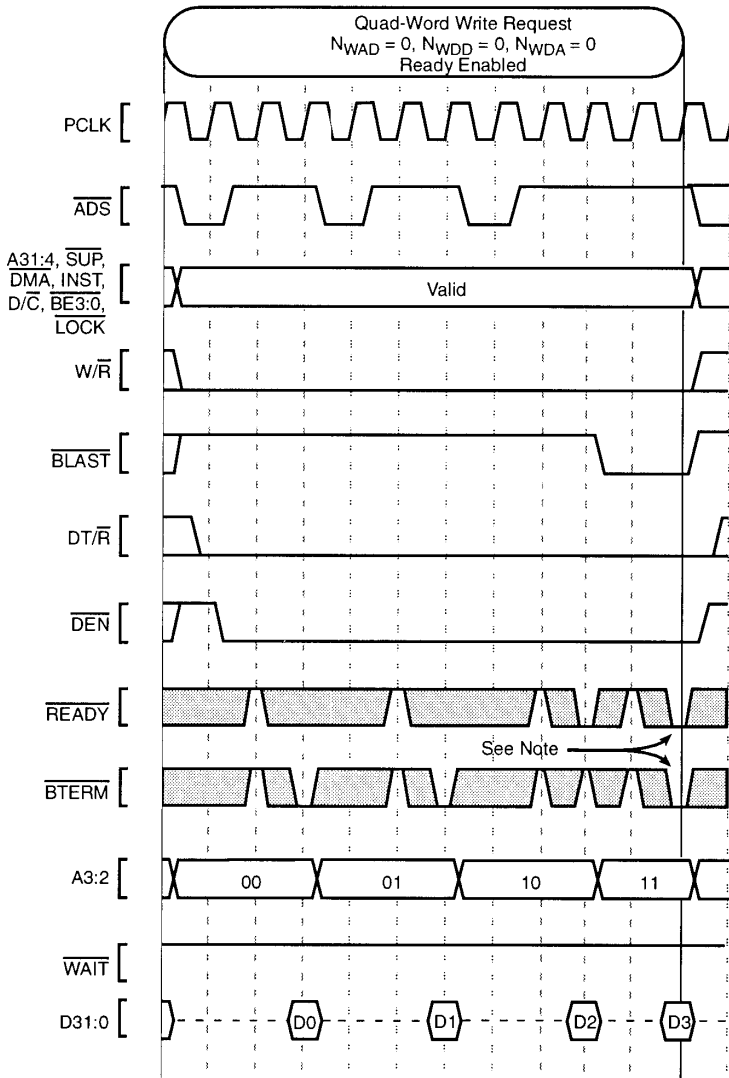

Figure 38. Using External READY



271327-39

NOTE:

READY adds memory access time to data transfers, whether or not the bus access is a burst access. BTERM interrupts a bus access, whether or not the bus access has more data transfers pending. Either the READY signal or the BTERM signal will terminate a bus access if the signal is asserted during the last (or only) data transfer of the bus access.

Figure 39. Terminating a Burst with BTERM

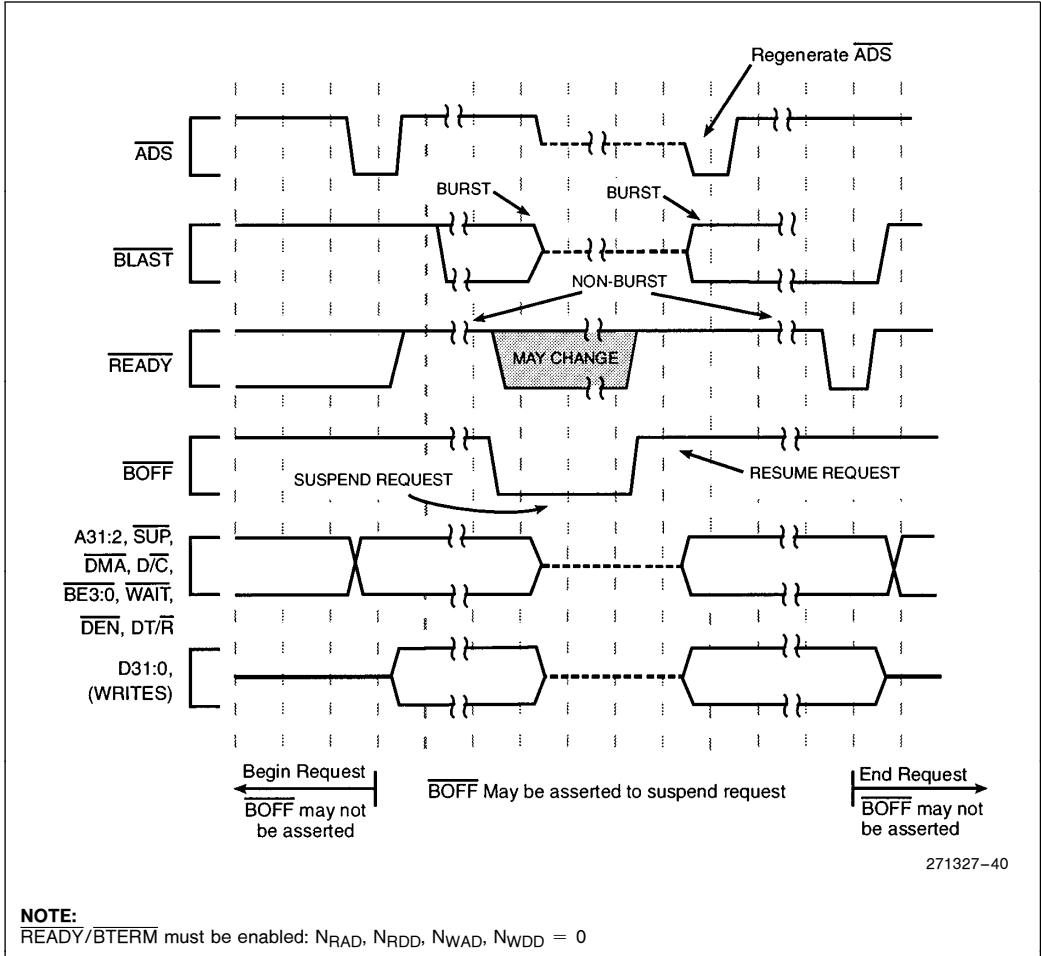

Figure 40. $\overline{\text{BOFF}}$ Functional Timing

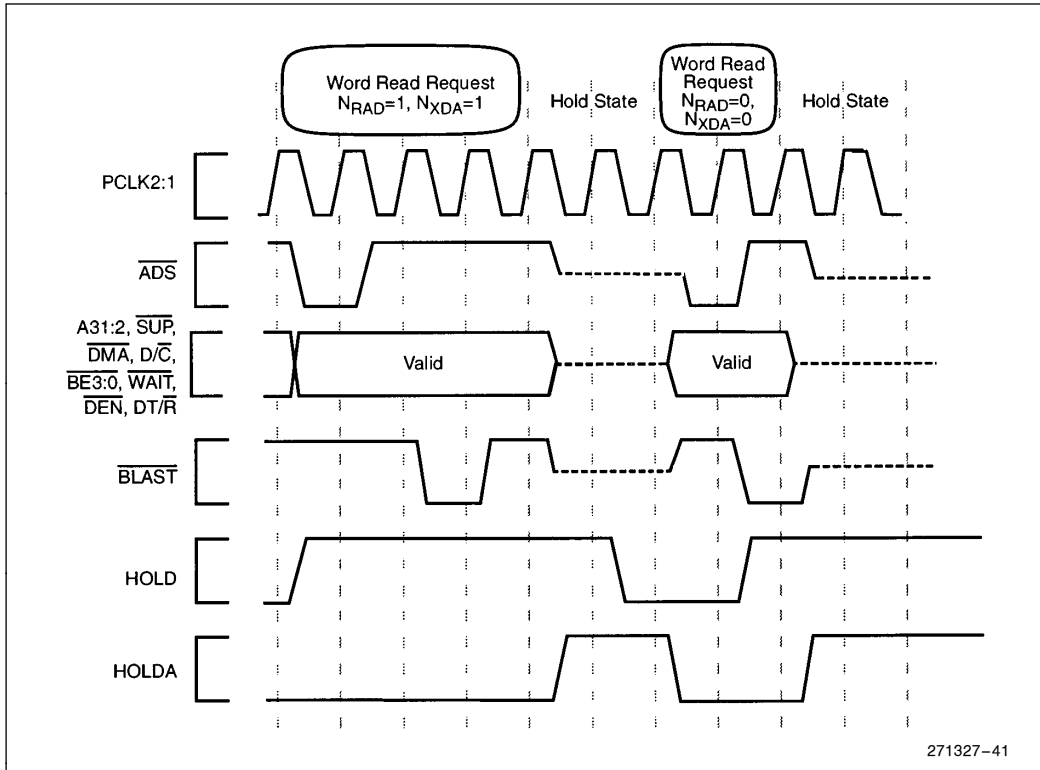

Figure 41. HOLD Functional Timing

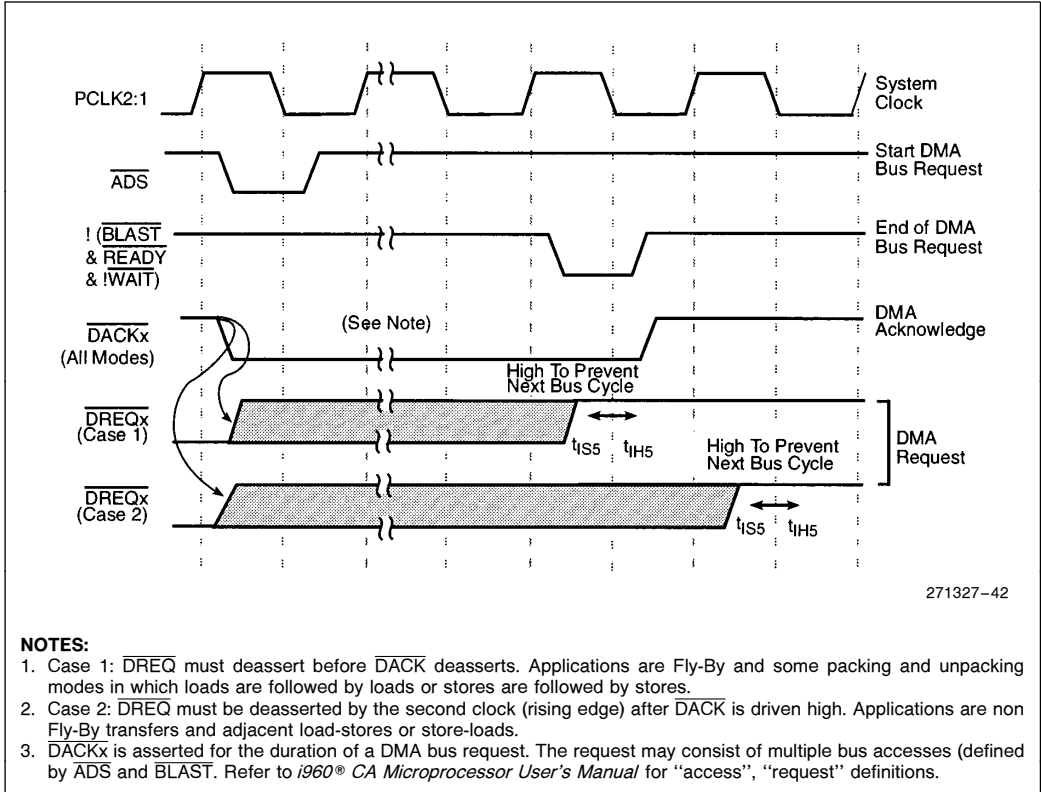

Figure 42. \overline{DREQ} and \overline{DACK} Functional Timing

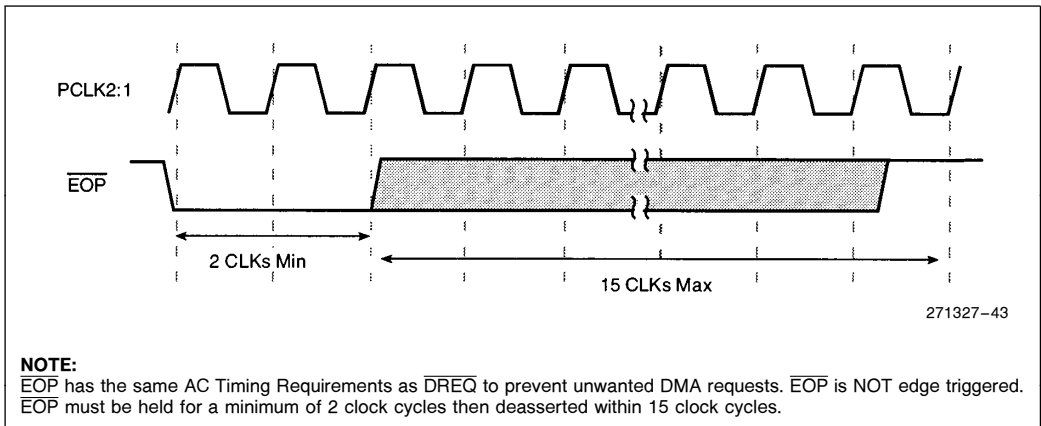

Figure 43. \overline{EOP} Functional Timing

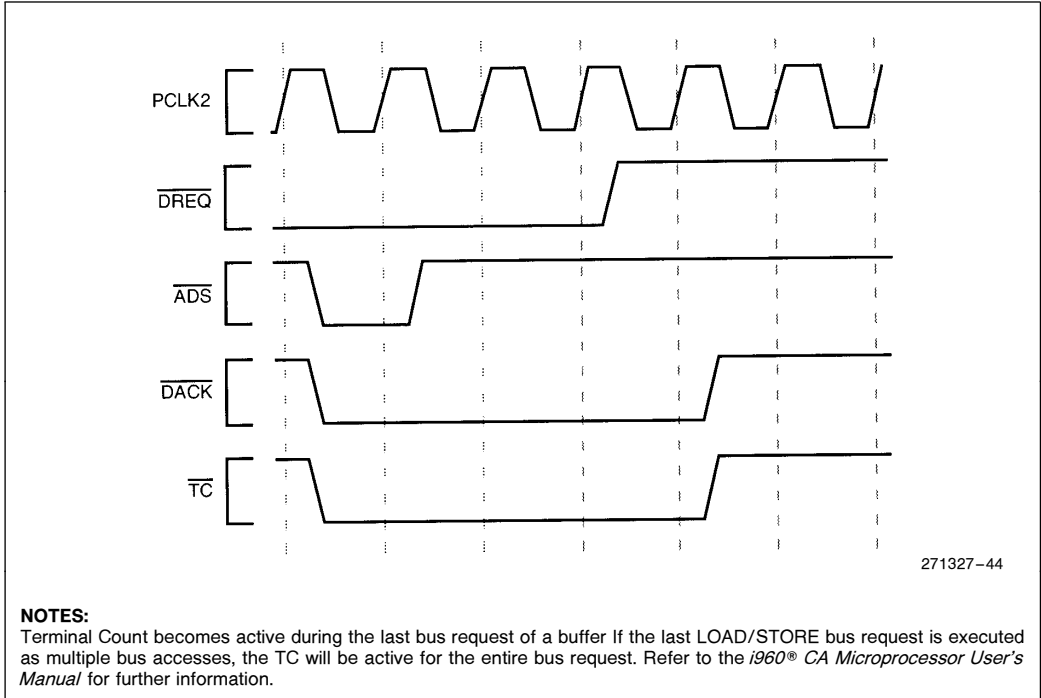

Figure 44. Terminal Count Functional Timing

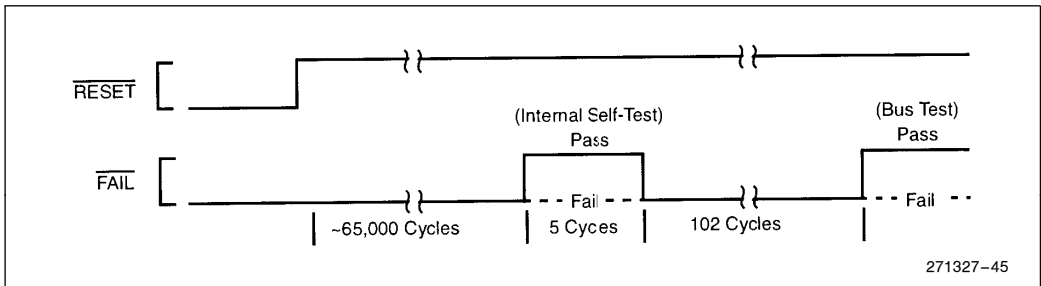

Figure 45. FAIL Functional Timing

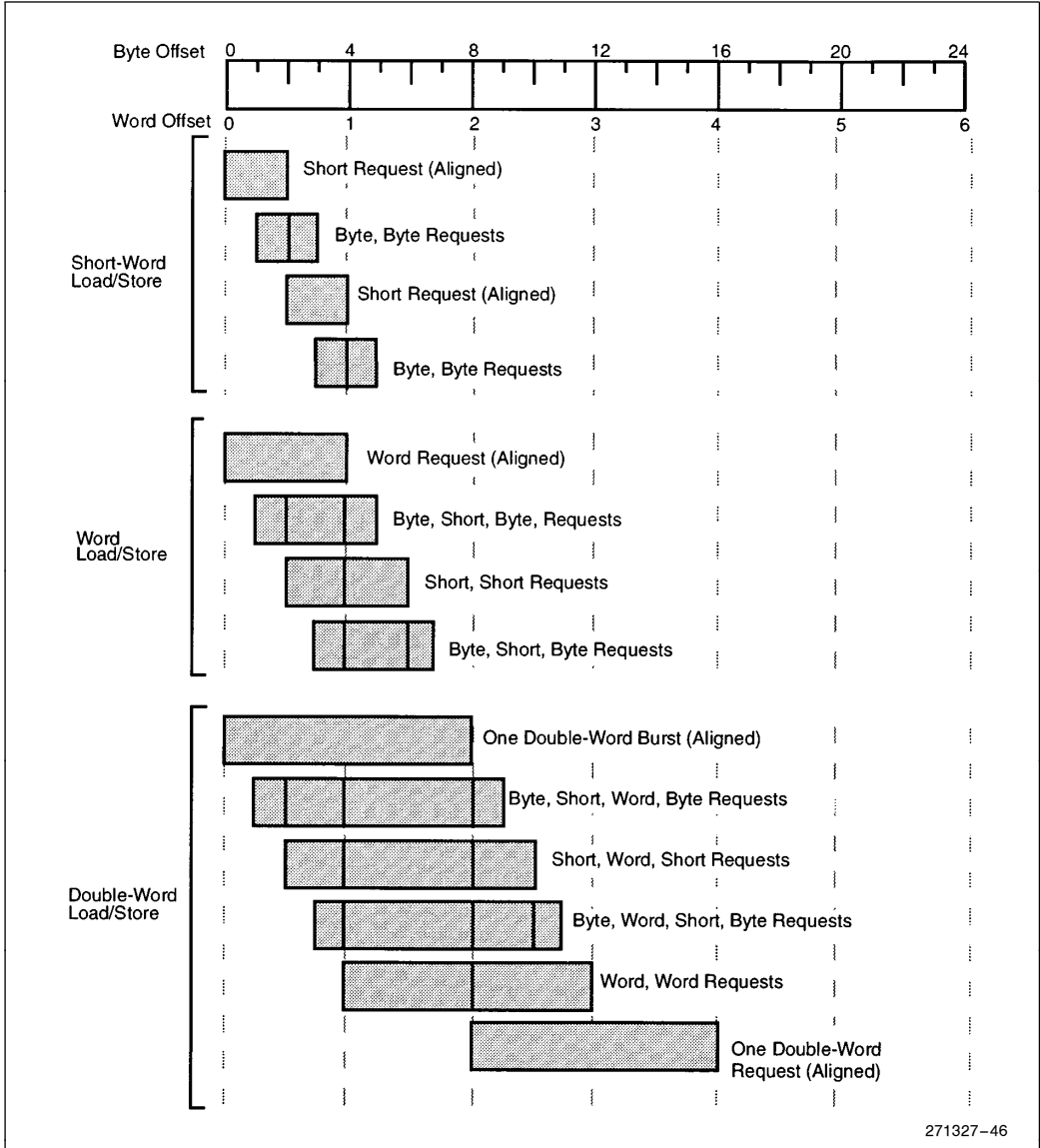

Figure 46. A Summary of Aligned and Unaligned Transfers for Little Endian Regions

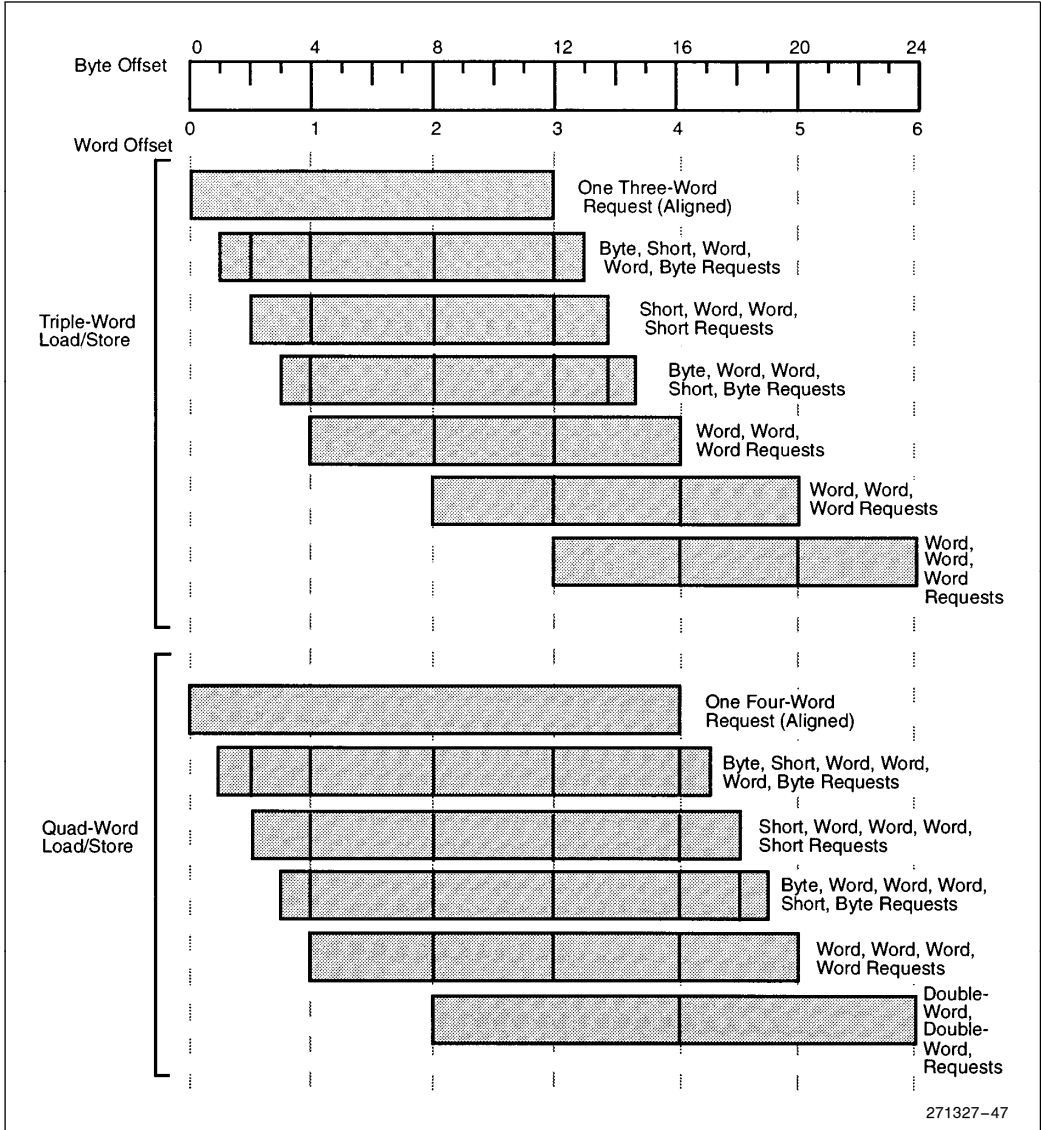
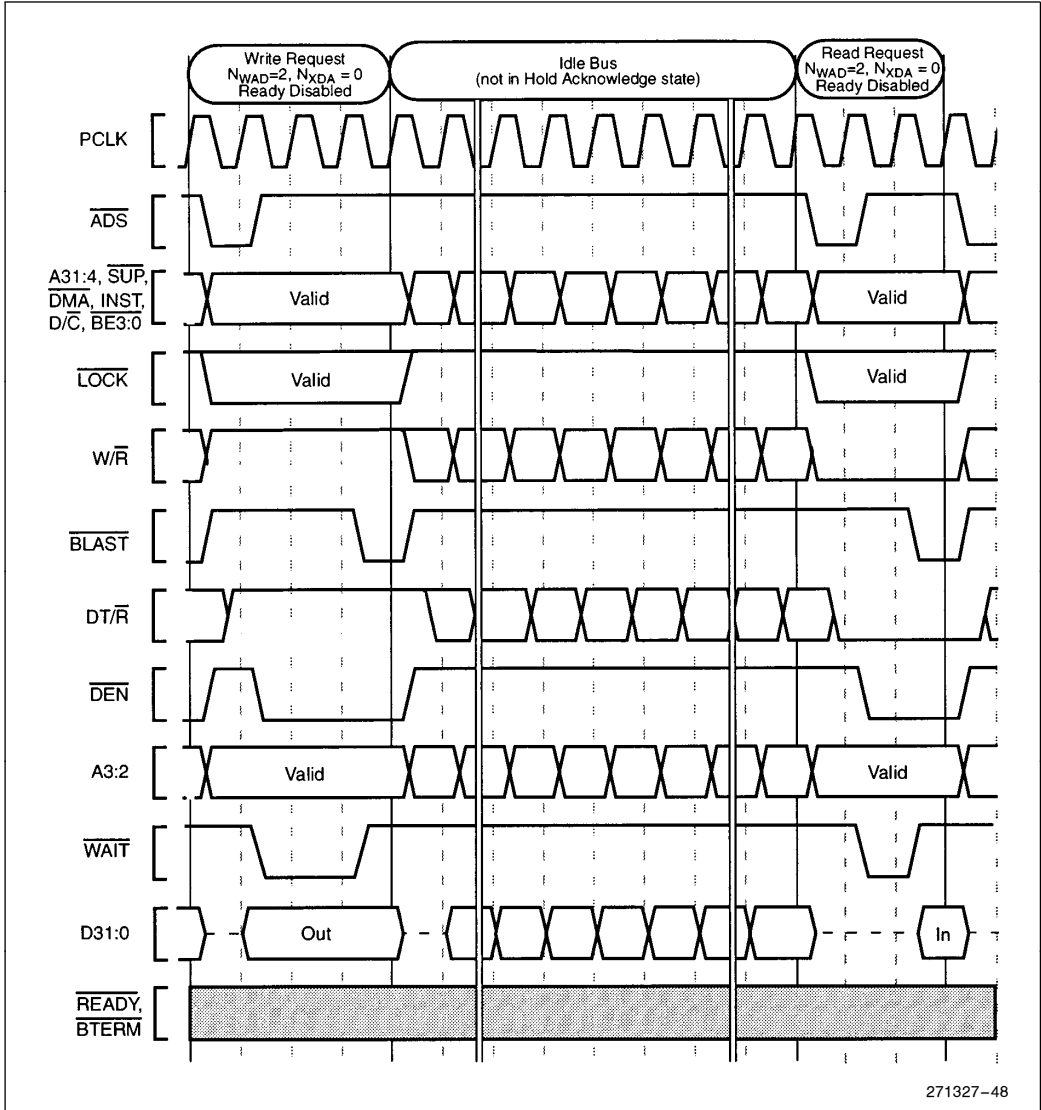

Figure 47. A Summary of Aligned and Unaligned Transfers for Little Endian Regions (Continued)



271327-48

Figure 48. Idle Bus Operation

7.0 REVISION HISTORY

New.

This datasheet has been download from:

www.datasheetcatalog.com

Datasheets for electronics components.