

**YELLOW GMA 8475C GMC 8475C
HER GMA 8875C GMC 8875C
GREEN GMA 8975C GMC 8975C
BICOLOR- RED/GREEN GMA 8675C GMC 8675C**

PACKAGE DIMENSIONS

A. GMX8X75C

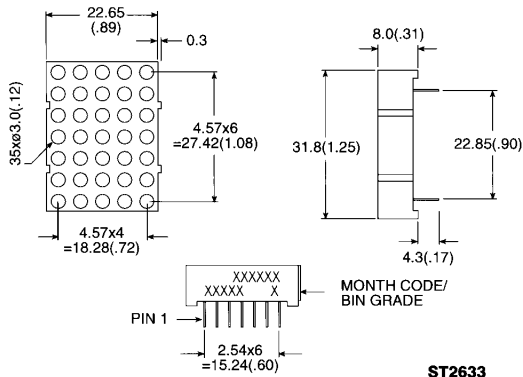

B. GMX8675C

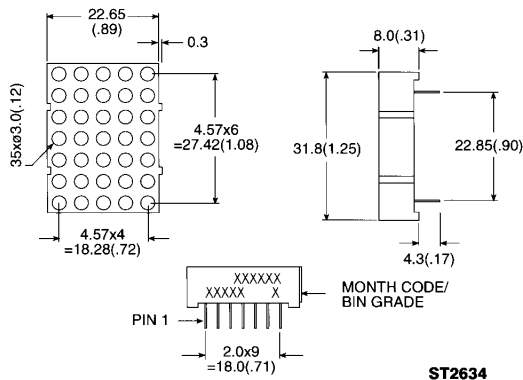

DESCRIPTION

The GMX8X75C series are 1.2" (30 mm) matrix height 5 × 7 dot matrix displays. All these parts are available in gray face and white dot color.

The X in GMX denotes row anode or row cathode.

FEATURES

- 1.2" (30 mm) matrix height
- Choice of 3 colors — green, yellow & HER and bicolor — red/green
- Low power consumption
- 5 × 7 array with X-Y select
- Stackable horizontally
- Choice of 2 matrix orientation cathode column or anode column
- Easy mounting or PCB on sockets
- Categorized for luminous intensity
- Multicolor color displays are applicable to 3 bright colors — green, orange (HER) and yellow (green and HER mixed)

NOTES:

1. ALL PINS ARE Ø0.5 (.02).
2. DIMENSIONS IN MILLIMETER (INCH), TOLERANCE IS ±0.25 (.01) UNLESS OTHERWISE NOTED.



**1.2" 5 x 7
DOT MATRIX DISPLAYS**

| ABSOLUTE MAXIMUM RATING (T _A = 25°C unless otherwise specified) | | | | |
|---|----------------|-----|-------|-------|
| PARAMETER | YELLOW | HER | GREEN | UNITS |
| Power dissipation per dot | 60 | 70 | 75 | mW |
| Peak forward current per dot (Duty cycle 1/10, 10KHz) | 80 | 100 | 100 | mA |
| Continuous I _F per dot | 20 | 5 | 25 | mA |
| Reverse voltage per dot | 5 | 5 | 5 | V |
| Operating and storage temperature range | -25°C to +85°C | | | |
| Soldering time at 260°C (1/16 inch below seating plane) | 3 sec | | | |

| MODEL NUMBERS | | | | | | |
|----------------------|----------|----------|-------------|---------------------------|-------------------|--------------------------|
| PART NO. | | | | DESCRIPTION | PACKAGE DIMENSION | INTERNAL CIRCUIT DIAGRAM |
| YELLOW | HER | GREEN | MULTI-COLOR | | | |
| GMC8475C | GMC8875C | GMC8975C | | Anode column, cathode row | A | A |
| GMA8475C | GMA8875C | GMA8975C | | Cathode column, anode row | A | B |
| | | | GMA8675C | Cathode column, anode row | B | C |
| | | | GMC8675C | Anode column, cathode row | B | D |

ELECTRICAL/OPTICAL CHARACTERISTICS ($T_A = 25^\circ\text{C}$ Unless otherwise specified)
GMX8475C (YELLOW)

| PARAMETER | MIN. | TYP. | MAX. | UNITS | TEST CONDITIONS |
|----------------------------|------|------|------|----------------|----------------------|
| Average luminous intensity | | 3000 | | μcd | $I_f = 20\text{ mA}$ |
| Peak emission wavelength | | 585 | | nm | $I_f = 20\text{ mA}$ |
| Spectral line half-width | | 35 | | nm | $I_f = 20\text{ mA}$ |
| Forward voltage, any dot | | 2.1 | 2.8 | V | $I_f = 20\text{ mA}$ |
| Reverse voltage, any dot | | | 100 | μA | $V_R = 5\text{ V}$ |

TYPICAL ELECTRICAL/OPTICAL CHARACTERISTIC CURVES

($T_A = 25^\circ\text{C}$ Unless otherwise specified)

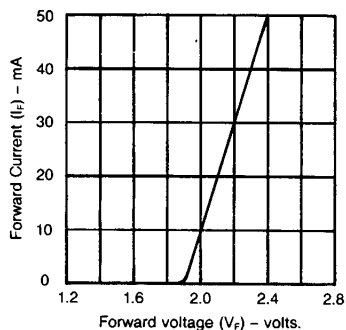

C3037

Fig. 1. Forward Current vs. Forward Voltage

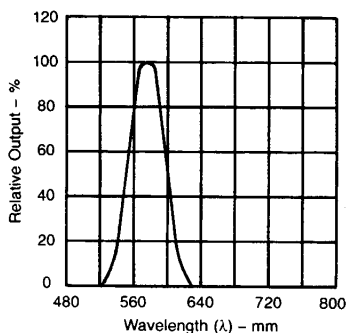

C3038

Fig. 2. Spectral Response

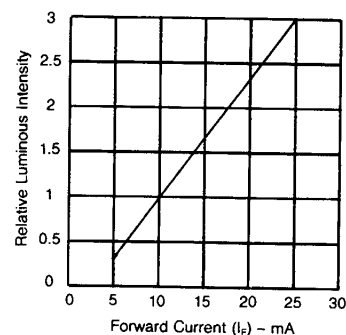

C3039

Fig. 3. Relative Luminous Intensity vs. Forward Current (Per Segment)

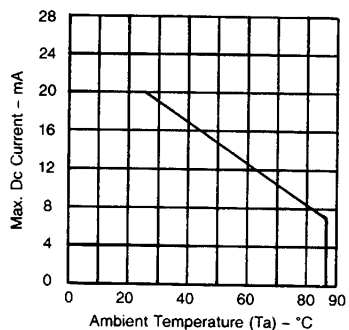

C3040

Fig. 4. Maximum Forward Allowable DC Current Per Segment vs. Ambient Temperature

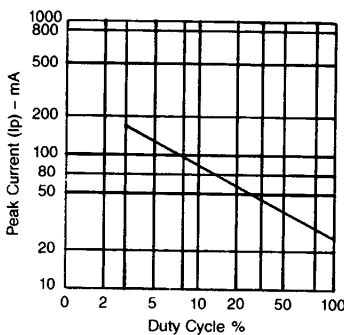

C3041

Fig. 5. Max Peak Current vs. Duty Cycle % (Refresh Rate $f = 1\text{ KHz}$)

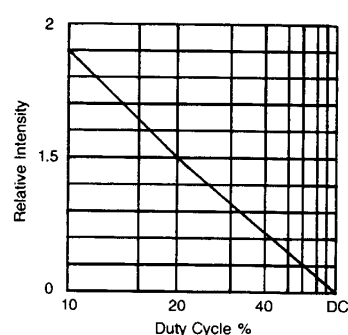

C3042

Fig. 6. Luminous Intensity vs. Duty Cycle % (Average $I = 10\text{ mA}$ Per Seg.)

ELECTRICAL/OPTICAL CHARACTERISTICS ($T_A = 25^\circ\text{C}$ Unless otherwise specified)
GMX8875C (HER)

| PARAMETER | MIN. | TYP. | MAX. | UNITS | TEST CONDITIONS |
|----------------------------|------|------|------|----------------|----------------------|
| Average luminous intensity | | 3000 | | μcd | $I_F = 20\text{ mA}$ |
| Peak emission wavelength | | 635 | | nm | $I_F = 20\text{ mA}$ |
| Spectral line half-width | | 30 | | nm | $I_F = 20\text{ mA}$ |
| Forward voltage, any dot | | 2.1 | 2.8 | V | $I_F = 20\text{ mA}$ |
| Reverse voltage, any dot | | | 100 | μA | $V_R = 5\text{ V}$ |

TYPICAL ELECTRICAL/OPTICAL CHARACTERISTIC CURVES

($T_A = 25^\circ\text{C}$ Unless otherwise specified)

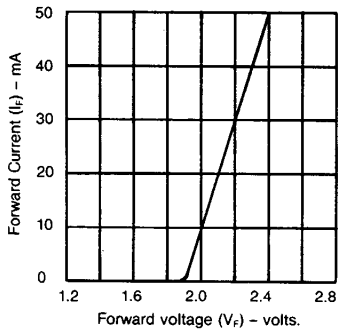

C3031

Fig. 1. Forward Current vs. Forward Voltage

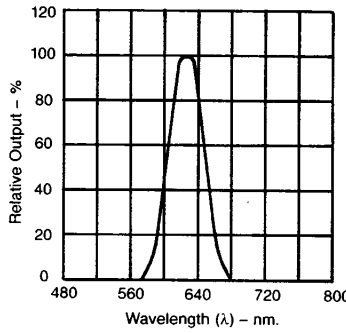

C3032

Fig. 2. Spectral Response

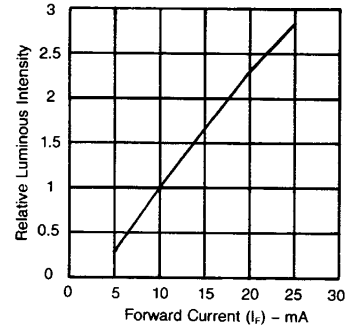

C3033

Fig. 3. Relative Luminous Intensity vs. Forward Current (Per Segment)

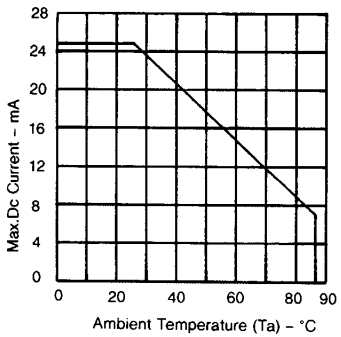

C3034

Fig. 4. Maximum Forward Allowable DC Current Per Segment vs. Ambient Temperature

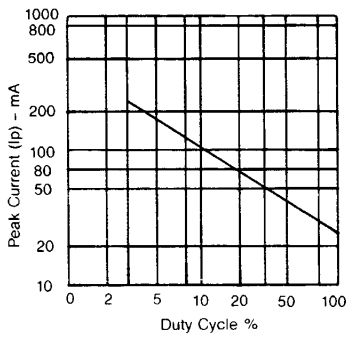

C3035

Fig. 5. Max Peak Current vs. Duty Cycle % (Refresh Rate $f = 1\text{ KHz}$)

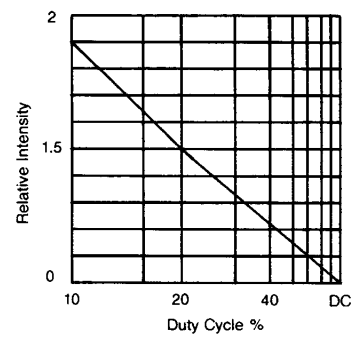

C3036

Fig. 6. Luminous Intensity vs. Duty Cycle % (Average $I = 10\text{ mA}$ Per Seg.)

| ELECTRICAL/OPTICAL CHARACTERISTICS ($T_A = 25^\circ\text{C}$ Unless otherwise specified) GMX8975C (GREEN) | | | | | |
|---|------|------|------|----------------|----------------------|
| PARAMETER | MIN. | TYP. | MAX. | UNITS | TEST CONDITIONS |
| Average luminous intensity | | 3000 | | μcd | $I_f = 20\text{ mA}$ |
| Peak emission wavelength | | 565 | | nm | $I_f = 20\text{ mA}$ |
| Spectral line half-width | | 30 | | nm | $I_f = 20\text{ mA}$ |
| Forward voltage, any dot | | 2.1 | 2.8 | V | $I_f = 20\text{ mA}$ |
| Reverse voltage, any dot | | | 100 | μA | $V_R = 5\text{ V}$ |

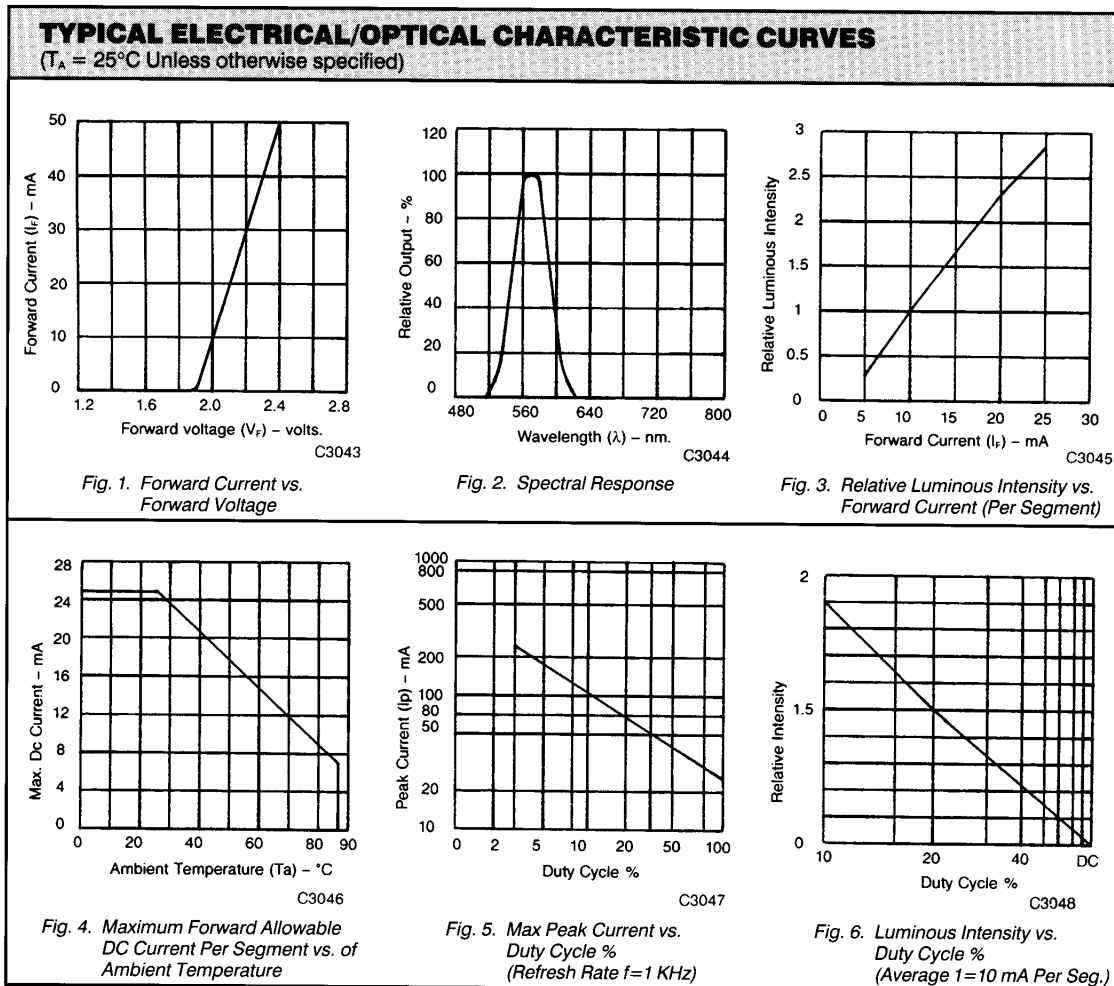

| PIN CONNECTION | | | | |
|-----------------------|------------------|-----------------|---------------------|-------------------|
| PIN NO. | GMA8X75C | GMC8X75C | GMC8675C | GMA8675C |
| 1 | Anode row 5 | Cathode row 5 | Cathode row 7 green | Anode row 7 green |
| 2 | Anode row 7 | Cathode row 7 | Cathode row 7 HER | Anode row 7 HER |
| 3 | Cathode column 2 | Anode column 2 | Anode column 1 | Cathode column 1 |
| 4 | Cathode column 3 | Anode column 3 | Anode column 2 | Cathode column 2 |
| 5 | Anode row 4 | Cathode row 4 | Anode column 3 | Cathode column 3 |
| 6 | Cathode column 5 | Anode column 5 | Anode column 4 | Cathode column 4 |
| 7 | Anode row 6 | Cathode row 6 | Anode column 5 | Cathode column 5 |
| 8 | Anode row 3 | Cathode row 3 | Cathode row 6 green | Anode row 6 green |
| 9 | Anode row 1 | Cathode row 1 | Cathode row 6 HER | Anode row 6 HER |
| 10 | Cathode column 4 | Anode column 4 | No connection | No connection |
| 11 | Cathode column 3 | Anode column 3 | Cathode row 5 green | Anode row 5 green |
| 12 | Anode row 4 | Cathode row 4 | Cathode row 5 HER | Anode row 5 HER |
| 13 | Cathode column 1 | Anode column 1 | Cathode row 4 green | Anode row 4 green |
| 14 | Anode row 2 | Cathode row 2 | Cathode row 4 HER | Anode row 4 HER |
| 15 | | | Cathode row 3 green | Anode row 3 green |
| 16 | | | Cathode row 3 HER | Anode row 3 HER |
| 17 | | | Cathode row 2 green | Anode row 2 green |
| 18 | | | Cathode row 2 HER | Anode row 2 HER |
| 19 | | | Cathode row 1 green | Anode row 1 green |
| 20 | | | Cathode row 1 HER | Anode row 1 HER |

INTERNAL CIRCUIT DIAGRAM

A. GMC8X75C

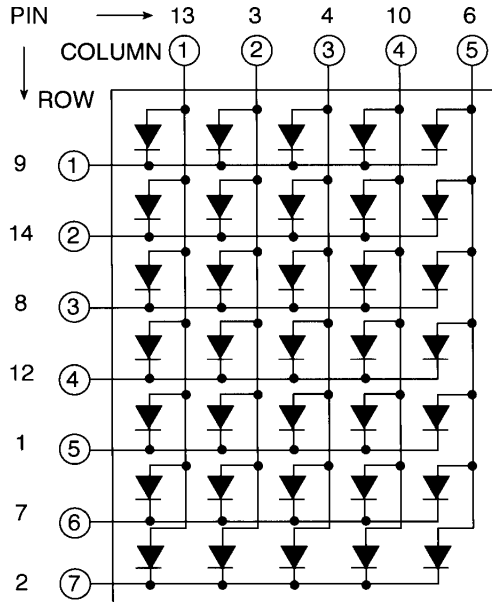

B. GMA8X75C

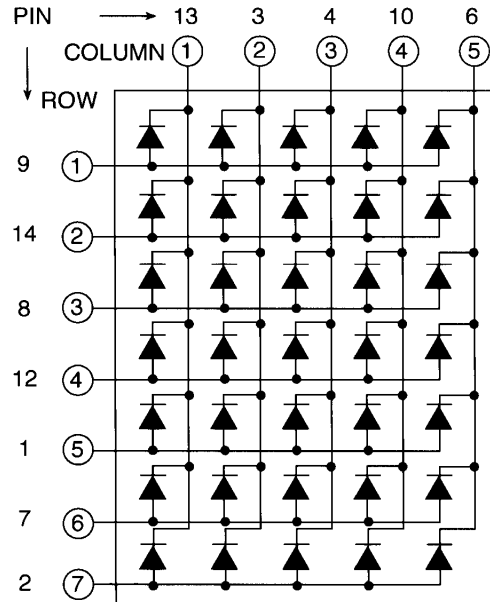

C. GMA8675C

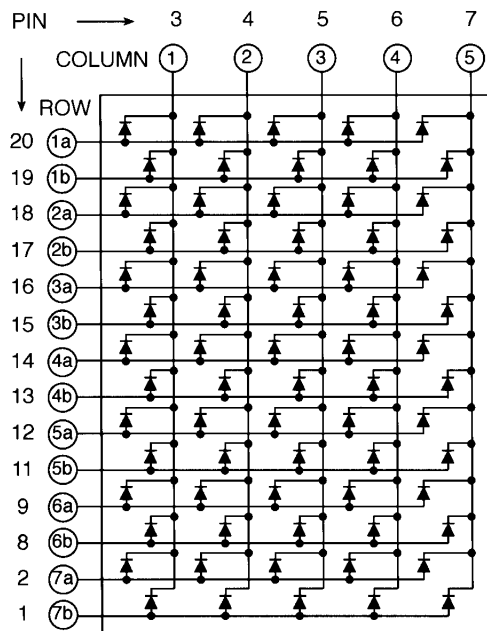

D. GMC8675C

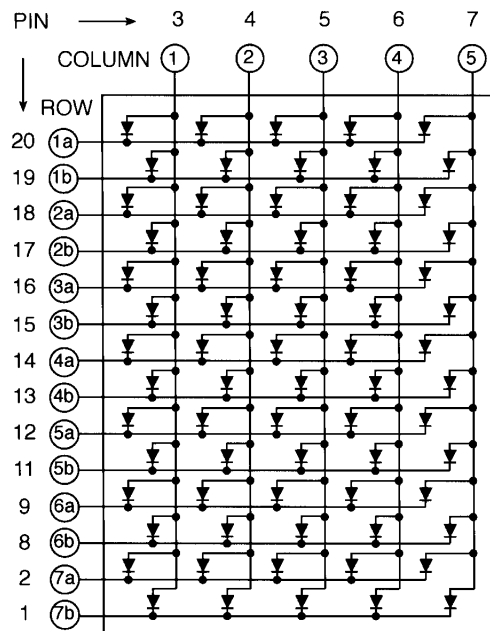



1.2" 5 X 7
DOT MATRIX DISPLAYS

DISCLAIMER

FAIRCHILD SEMICONDUCTOR RESERVES THE RIGHT TO MAKE CHANGES WITHOUT FURTHER NOTICE TO ANY PRODUCTS HEREIN TO IMPROVE RELIABILITY, FUNCTION OR DESIGN. FAIRCHILD DOES NOT ASSUME ANY LIABILITY ARISING OUT OF THE APPLICATION OR USE OF ANY PRODUCT OR CIRCUIT DESCRIBED HEREIN; NEITHER DOES IT CONVEY ANY LICENSE UNDER ITS PATENT RIGHTS, NOR THE RIGHTS OF OTHERS.

LIFE SUPPORT POLICY

FAIRCHILD'S PRODUCTS ARE NOT AUTHORIZED FOR USE AS CRITICAL COMPONENTS IN LIFE SUPPORT DEVICES OR SYSTEMS WITHOUT THE EXPRESS WRITTEN APPROVAL OF THE PRESIDENT OF FAIRCHILD SEMICONDUCTOR CORPORATION. As used herein:

1. Life support devices or systems are devices or systems which, (a) are intended for surgical implant into the body, or (b) support or sustain life, and (c) whose failure to perform when properly used in accordance with instructions for use provided in the labeling, can be reasonably expected to result in a significant injury of the user.
2. A critical component in any component of a life support device or system whose failure to perform can be reasonably expected to cause the failure of the life support device or system, or to affect its safety or effectiveness.