

MBR4035PT - MBR4060PT

Features

- Low power loss, high efficiency.
- High surge capacity.
- For use in low voltage, high frequency inverters, free wheeling, and polarity protection applications.
- Metal silicon junction, majority carrier conduction.
- High current capacity, low forward voltage drop.
- Guard ring for over voltage protection.



TO-3P/TO-247AD

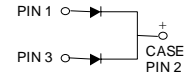

Schottky Rectifiers

Absolute Maximum Ratings*

$T_A = 25^\circ\text{C}$ unless otherwise noted

Symbol	Parameter	Value				Units
		4035PT	4045PT	4050PT	4060PT	
V_{RRM}	Maximum Repetitive Reverse Voltage	35	45	50	60	V
$I_{F(AV)}$	Average Rectified Forward Current .375" lead length @ $T_A = 125^\circ\text{C}$	40				A
I_{FSM}	Non-repetitive Peak Forward Surge Current 8.3 ms Single Half-Sine-Wave	400				A
T_{stg}	Storage Temperature Range	-65 to +175				$^\circ\text{C}$
T_J	Operating Junction Temperature	-65 to +150				$^\circ\text{C}$

*These ratings are limiting values above which the serviceability of any semiconductor device may be impaired.

Thermal Characteristics

Symbol	Parameter	Value	Units
P_D	Power Dissipation	3.0	W
$R_{\theta JL}$	Thermal Resistance, Junction to Lead	1.2	$^\circ\text{C/W}$

Electrical Characteristics

$T_A = 25^\circ\text{C}$ unless otherwise noted

Symbol	Parameter	Device				Units
		4035PT	4045PT	4050PT	4060PT	
V_F	Forward Voltage $I_F = 20\text{ A}, T_C = 25^\circ\text{C}$	0.70		0.72		V
	$I_F = 20\text{ A}, T_C = 125^\circ\text{C}$	0.60		0.62		V
	$I_F = 40\text{ A}, T_C = 25^\circ\text{C}$	0.80		-		V
	$I_F = 40\text{ A}, T_C = 125^\circ\text{C}$	0.75		-		V
I_R	Reverse Current @ rated V_R $T_A = 25^\circ\text{C}$	1.0				mA
	$T_A = 125^\circ\text{C}$	100				mA
I_{RRM}	Peak Repetitive Reverse Surge Current 2.0 us Pulse Width, $f = 1.0\text{ KHz}$	2.0		1.0		A

Typical Characteristics

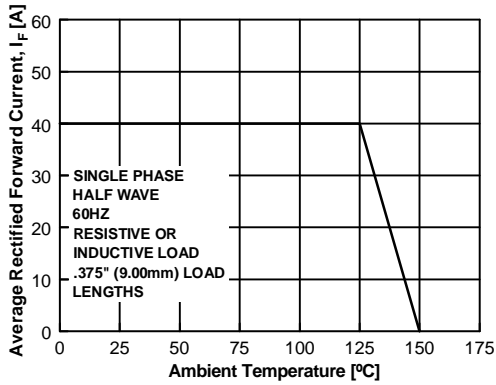

Figure 1. Forward Current Derating Curve

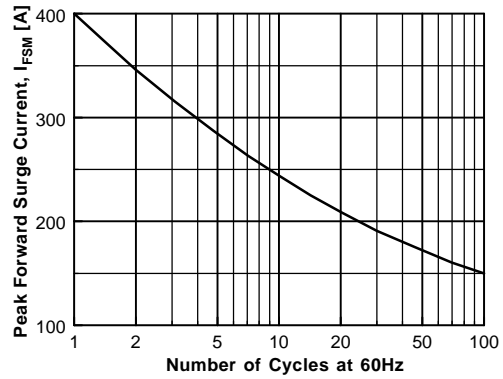

Figure 2. Non-Repetitive Surge Current

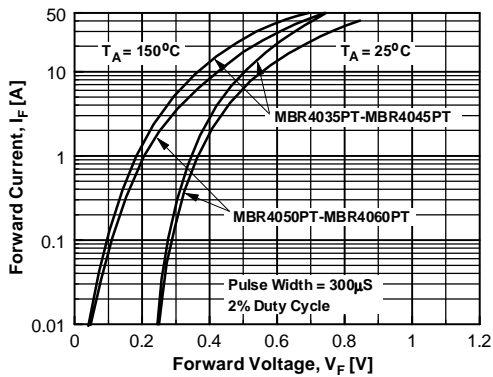

Figure 3. Forward Voltage Characteristics

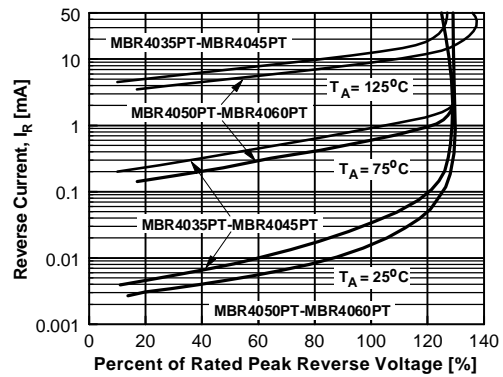

Figure 4. Reverse Current vs Reverse Voltage

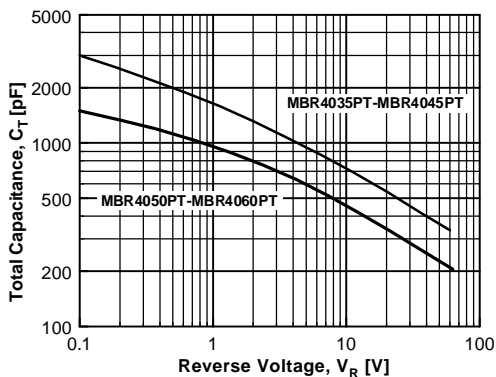

Figure 5. Total Capacitance

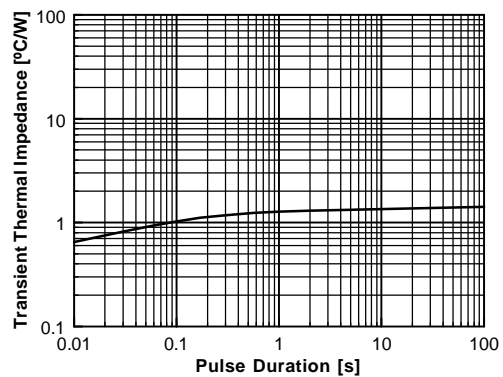

Figure 6. Thermal Impedance Characteristics

TRADEMARKS

The following are registered and unregistered trademarks Fairchild Semiconductor owns or is authorized to use and is not intended to be an exhaustive list of all such trademarks.

ACE _x TM	FAST [®]	OPTOLOGIC TM	SMART START TM	VCX TM
Bottomless TM	FAST _r TM	OPTOPLANAR TM	STAR*POWER TM	
CoolFET TM	FRFET TM	PACMAN TM	Stealth TM	
CROSSVOLT TM	GlobalOptoisolator TM	POPT TM	SuperSOT TM -3	
DenseTrench TM	GTO TM	Power247 TM	SuperSOT TM -6	
DOMET TM	HiSeC TM	PowerTrench [®]	SuperSOT TM -8	
EcoSPARK TM	ISOPLANAR TM	QFET TM	SyncFET TM	
E ² CMOS TM	LittleFET TM	QST TM	TinyLogic TM	
EnSigna TM	MicroFET TM	QT Optoelectronics TM	TruTranslation TM	
FACT TM	MicroPak TM	Quiet Series TM	UHC TM	
FACT Quiet Series TM	MICROWIRE TM	SILENT SWITCHER [®]	UltraFET [®]	

STAR*POWER is used under license

DISCLAIMER

FAIRCHILD SEMICONDUCTOR RESERVES THE RIGHT TO MAKE CHANGES WITHOUT FURTHER NOTICE TO ANY PRODUCTS HEREIN TO IMPROVE RELIABILITY, FUNCTION OR DESIGN. FAIRCHILD DOES NOT ASSUME ANY LIABILITY ARISING OUT OF THE APPLICATION OR USE OF ANY PRODUCT OR CIRCUIT DESCRIBED HEREIN; NEITHER DOES IT CONVEY ANY LICENSE UNDER ITS PATENT RIGHTS, NOR THE RIGHTS OF OTHERS.

LIFE SUPPORT POLICY

FAIRCHILD'S PRODUCTS ARE NOT AUTHORIZED FOR USE AS CRITICAL COMPONENTS IN LIFE SUPPORT DEVICES OR SYSTEMS WITHOUT THE EXPRESS WRITTEN APPROVAL OF FAIRCHILD SEMICONDUCTOR CORPORATION.

As used herein:

1. Life support devices or systems are devices or systems which, (a) are intended for surgical implant into the body, or (b) support or sustain life, or (c) whose failure to perform when properly used in accordance with instructions for use provided in the labeling, can be reasonably expected to result in significant injury to the user.
2. A critical component is any component of a life support device or system whose failure to perform can be reasonably expected to cause the failure of the life support device or system, or to affect its safety or effectiveness.

PRODUCT STATUS DEFINITIONS

Definition of Terms

Datasheet Identification	Product Status	Definition
Advance Information	Formative or In Design	This datasheet contains the design specifications for product development. Specifications may change in any manner without notice.
Preliminary	First Production	This datasheet contains preliminary data, and supplementary data will be published at a later date. Fairchild Semiconductor reserves the right to make changes at any time without notice in order to improve design.
No Identification Needed	Full Production	This datasheet contains final specifications. Fairchild Semiconductor reserves the right to make changes at any time without notice in order to improve design.
Obsolete	Not In Production	This datasheet contains specifications on a product that has been discontinued by Fairchild semiconductor. The datasheet is printed for reference information only.