

## ENERGIZER NO. EN92

## AAA

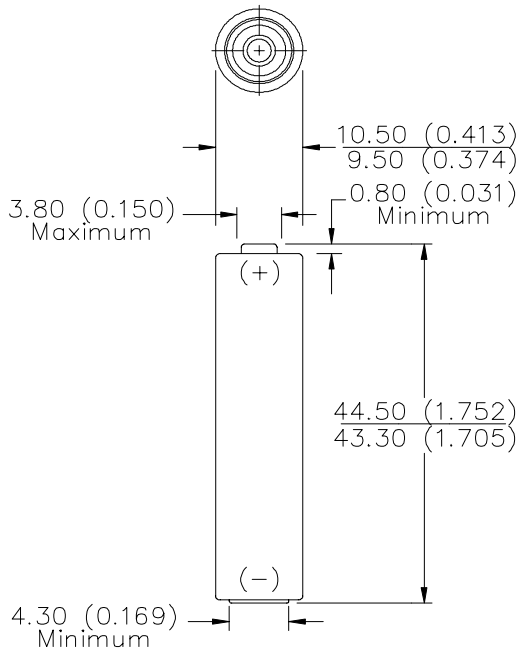

Industry Standard Dimensions in mm (inches)



### NOT INTENDED FOR RETAIL TRADE

<b>Chemical System:</b>	Alkaline Zinc-Manganese Dioxide (Zn/MnO <sub>2</sub> ) (No Added Mercury or Cadmium)
<b>Designation:</b>	ANSI-24A, IEC-LR03
<b>Battery Voltage:</b>	1.5 Volts
<b>Internal Resistance:</b>	205 Milliohms (Fresh)
<b>Operating Temp:</b>	-18°C to 55°C (0°F to 130°F)
<b>Average Capacity:</b>	1,250 mAh (to 0.8 volts) (Rated capacity at 25 mA continuous drain)
<b>Average Weight:</b>	11.5 grams (0.4 oz.)
<b>Volume:</b>	3.8 cubic centimeters (0.2 cubic inch)
<b>Cell:</b>	One No. 3-312 (size 'AAA')
<b>Jacket:</b>	Plastic Label
<b>Shelf Life:</b>	7 years (80% of rated capacity)

### TEMPERATURE EFFECTS

#### Typical Service to 0.8 Volts

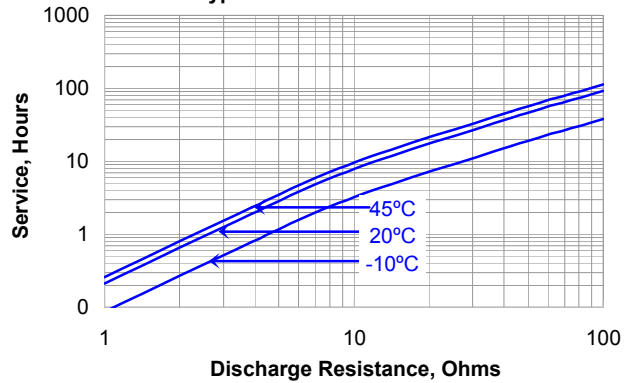

### CONSTANT RESISTANCE PERFORMANCE

#### Typical Service

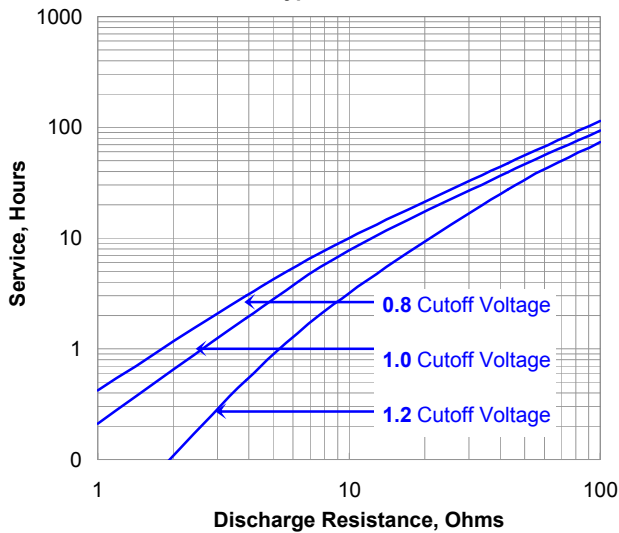

### CONSTANT CURRENT DISCHARGE

#### Typical Service

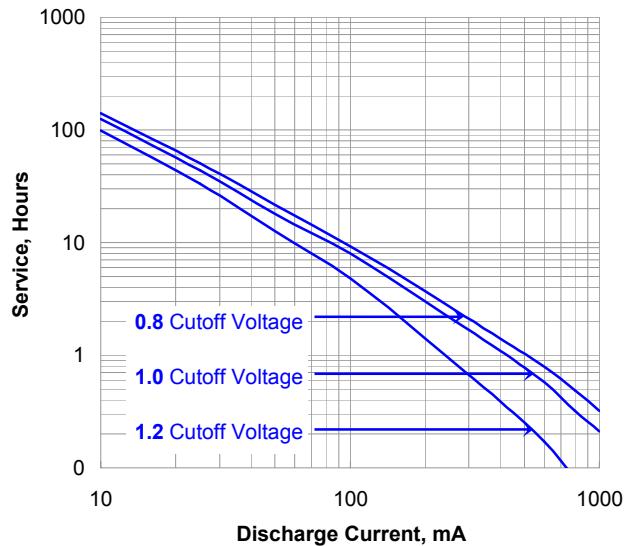

### Important Notice

This data sheet contains information specific to batteries manufactured at the time of its publication.

**Contents herein do not constitute a warranty.**

Copyright © Eveready Battery Co. - All rights reserved

**ENERGIZER NO. EN92**

**CONSTANT POWER DISCHARGE  
Typical Service**

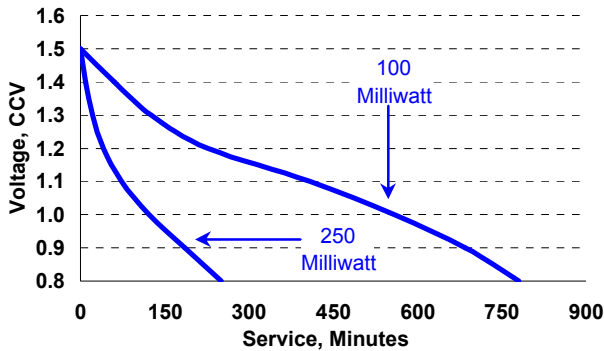

**CONSTANT POWER DISCHARGE  
Typical Service**

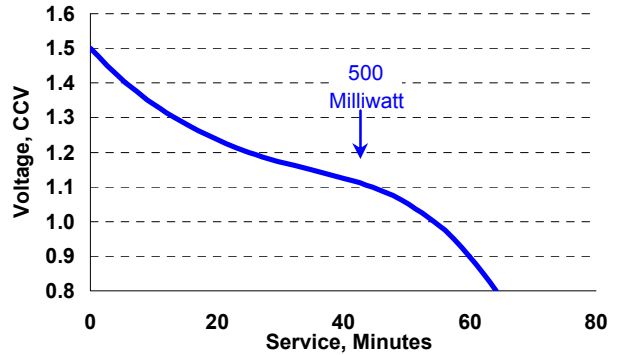

**Industry Standard Tests @ 20° C**

**LIGHTING  
5.1 ohm - 4 min/hr 8 hr/day**

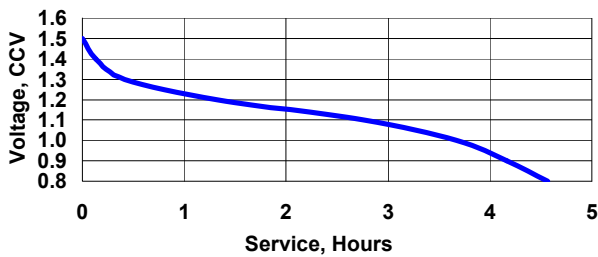

**PHOTOFLASH  
600 mA - 10 sec/min 1 hr/day**

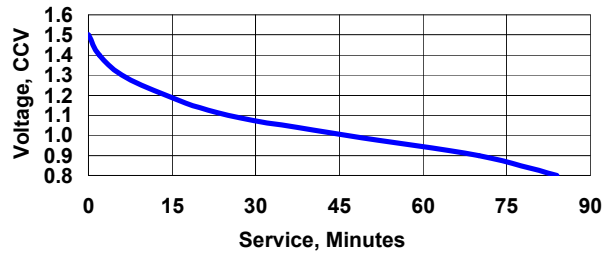

**REMOTE  
24 ohm - 15 spm - 8 hr/day**

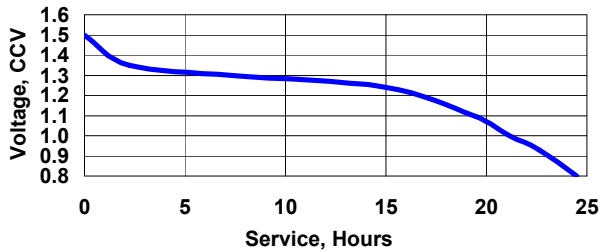

**TAPE - ELECTRONIC GAMES-DIGITAL AUDIO  
100 mA - 1 hr/day**

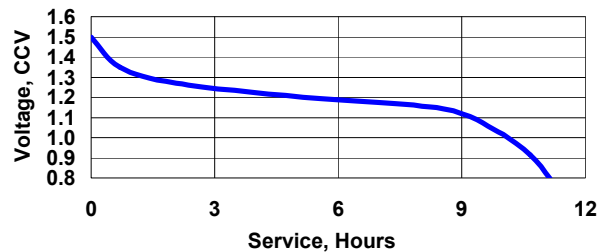

**Important Notice**

This data sheet contains information specific to batteries manufactured at the time of its publication.

**Contents herein do not constitute a warranty.**

Copyright © Eveready Battery Co. - All rights reserved