

SERIES OF ADJUSTABLE MICROPOWER VOLTAGE REGULATOR

The KIA2951P/F are micropower voltage regulators with very low quiescent current ($75\mu\text{A}$ Typ.) and very low dropout voltage (Typ. 40mV at light loads and 380mV at 100mA). They are ideally suited for use in battery-powered systems. Furthermore, the quiescent current of the KIA2951P/F increases only slightly in dropout, prolonging battery life. One such feature is an error flag output which warns of a low output voltage, often due to falling batteries on the input. It may be used for a power-on reset. A second feature is the logic-compatible shutdown input which enables the regulator to be switched on and off. Also the part may be pin-strapped for a 5V , 3V , or 3.3V output (depending on the version), or programmed from 1.24V to 10V with an external pair of resistors.

Careful design of the KIA2951P/F has minimized all contributions to the error budget. This includes a tight initial tolerance (5% typ.), extremely good load and line regulation (0.05% typ.) and a very low output voltage temperature coefficient, marking the part useful as a low-power voltage reference.

FEATURES

- 5V , 3V and 3.3V versions available.
- High accuracy output voltage.
- Guaranteed 100mA output current.
- Extremely tight load and line regulation.
- Very low temperature coefficient.
- Use as Regulator or Reference.
- Needs minimum capacitance for stability.
- Current and Thermal Limiting.
- Stable with low-ESR output dropout.
- Error flag warns of output dropout.
- Logic-controlled electronic shutdown.
- Output programmable from 1.24 to 10V .

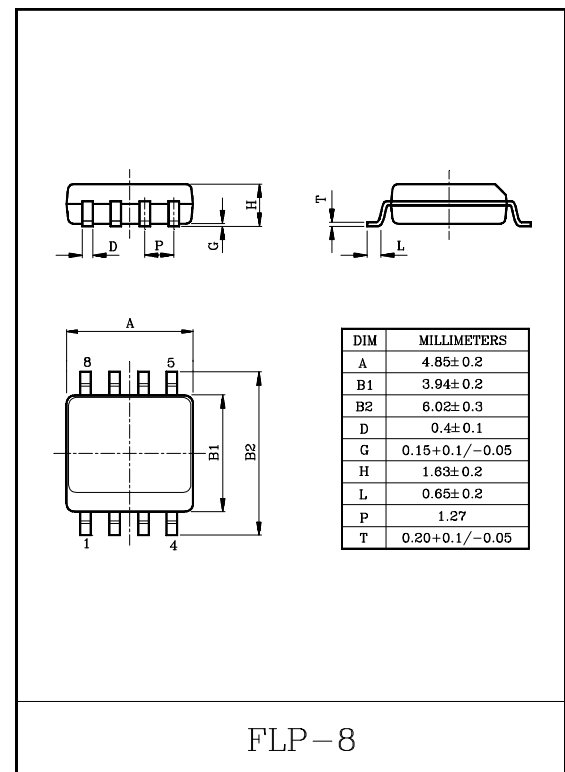
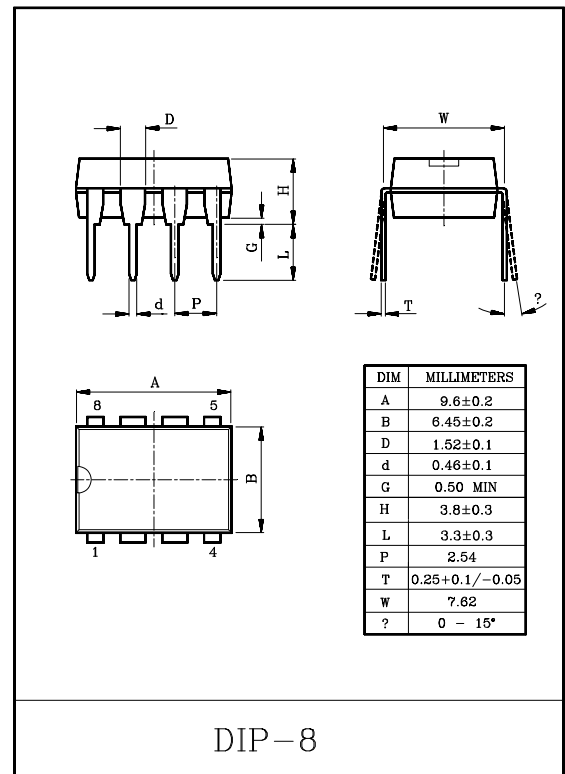

KIA2951P/F

MAXIMUM RATINGS (Ta=25°C)

CHARACTERISTIC		SYMBOL	RATING	UNIT
Input Supply Voltage		V_{IN}	-0.3 ~ 30	V
Shutdown Input Voltage		V_{SD}	-1.5 ~ 30	V
Error Comparator Output Voltage		V_{EC}	-1.5 ~ 30	V
FeedBack Input Voltage		V_{FB}	-1.5 ~ 30	V
Power Dissipation	P	P_D	500	W
	F		240	
Junction Temperature		T_j	150	°C
Operating Junction Temperature		T_{opr}	-55 ~ 150	°C
Storage Junction Temperature		T_{stg}	-65 ~ 150	°C

BLOCK DIAGRAM

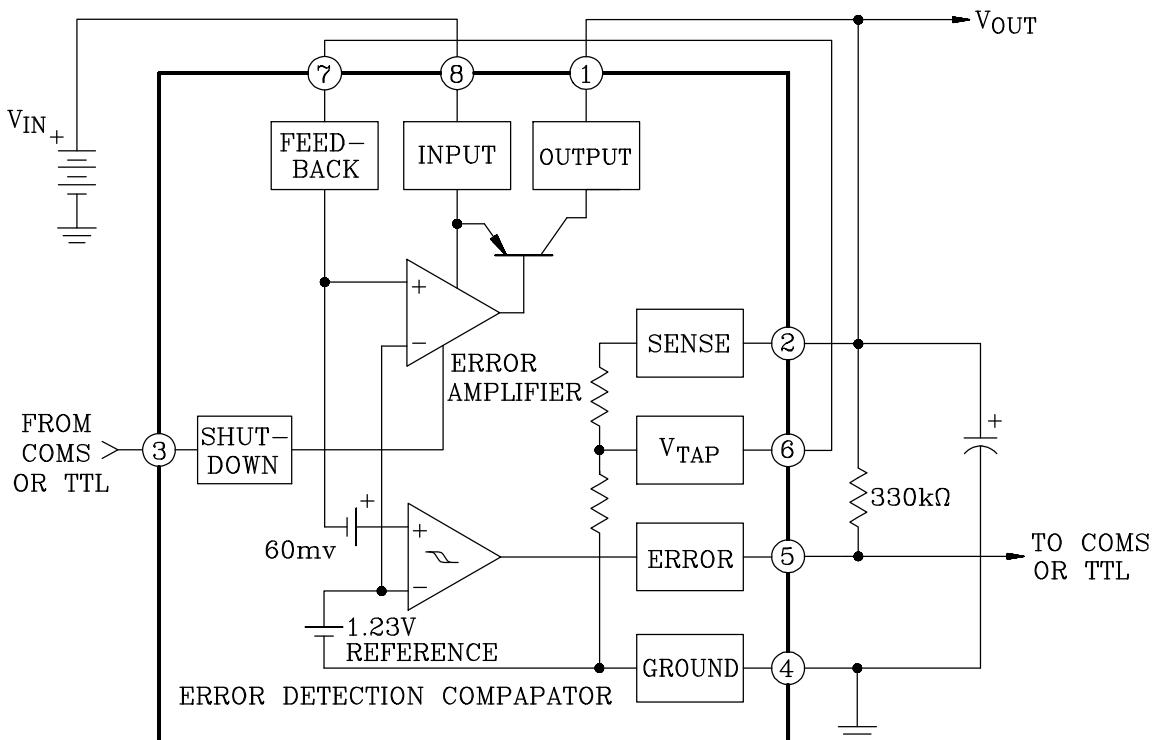

KIA2951P/F

ELECTRICAL CHARACTERISTICS

3V CONDITION

(Unless otherwise Specified : $V_{IN}=V_{O(TYP)}+1$, $I_{OUT}=100\mu A$, $C_{OUT}=2.2\mu F$)

CHARACTERISTIC	SYMBOL	TEST CONDITION	MIN.	TYP.	MAX.	UNIT
Output Voltage	V_{OUT1}	$T_J=25^\circ C$	2.985	3.0	3.015	V
	V_{OUT2}	$-25^\circ C \leq T_J \leq 85^\circ C$	-	3.0	-	V
	V_{OUT3}	Full Operating Temperature Range	2.964	3.0	3.036	V
Output Voltage	V_{OUT4}	$100\mu A \leq I_{OUT} \leq 100mA$, $T_J \leq T_{J(MAX)}$	2.955	3.0	3.045	V

3.3V CONDITION

(Unless otherwise Specified : $V_{IN}=V_{O(TYP)}+1$, $I_{OUT}=100\mu A$, $C_{OUT}=2.2\mu F$)

CHARACTERISTIC	SYMBOL	TEST CONDITION	MIN.	TYP.	MAX.	UNIT
Output Voltage	V_{OUT1}	$T_J=25^\circ C$	3.284	3.3	3.317	V
	V_{OUT2}	$-25^\circ C \leq T_J \leq 85^\circ C$	-	3.3	-	V
	V_{OUT3}	Full Operating Temperature Range	3.260	3.3	3.340	V
Output Voltage	V_{OUT4}	$100\mu A \leq I_{OUT} \leq 100mA$, $T_J \leq T_{J(MAX)}$	3.251	3.3	3.350	V

5V CONDITION

(Unless otherwise Specified : $V_{IN}=V_{O(TYP)}+1$, $I_{OUT}=100\mu A$, $C_{OUT}=1\mu F$)

CHARACTERISTIC	SYMBOL	TEST CONDITION	MIN.	TYP.	MAX.	UNIT
Output Voltage	V_{OUT1}	$T_J=25^\circ C$	4.975	5.0	5.025	V
	V_{OUT2}	$-25^\circ C \leq T_J \leq 85^\circ C$	-	5.0	-	V
	V_{OUT3}	Full Operating Temperature Range	4.940	5.0	5.060	V
Output Voltage	V_{OUT4}	$100\mu A \leq I_{OUT} \leq 100mA$, $T_J \leq T_{J(MAX)}$	4.925	5.0	5.075	V

KIA2951P/F

ALL VOLTAGE CONDITION

(Unless otherwise Specified : $V_{IN}=V_{O(TYP)}+1$, $I_{OUT}=100\mu A$)

CHARACTERISTIC	SYMBOL	TEST CONDITION	MIN.	TYP.	MAX.	UNIT
Output Voltage Temperature Coefficient	TCV_O		-	20	120	ppm/°C
Line Regulation	Reg line	$V_{O(TYP)}+1 \leq V_{IN} \leq 30V$	-	0.03	0.1	%
Load Regulation	Reg load	$100\mu A \leq I_{OUT} \leq 100mA$	-	0.04	0.1	%
Dropout Voltage	V_{D1}	$I_{OUT}=100\mu A$	-	50	80	mV
	V_{D2}	$I_{OUT}=100mA$	-	380	450	mV
Quiescent Current	I_{Q1}	$I_{OUT}=100\mu A$	-	75	120	μA
	I_{Q2}	$V_{IN}=V_{O(TYP)}-0.5$, $I_{OUT}=100\mu A$	-	110	170	μA
	I_{Q3}	$I_{OUT}=100mA$	-	8	12	mA
Current Limit	I_{LIMIT}	$V_{OUT}=0$	-	160	200	mA
Output Noise Voltage	V_{NO1}	$C_{OUT}=1\mu F$ (5V Only), BW=10Hz~100kHz	-	430	-	μV_{RMS}
	V_{NO2}	$C_{OUT}=220\mu F$, BW=10Hz~100kHz	-	160	-	μV_{RMS}
	V_{NO3}	$C_{OUT}=3.3\mu F$, (Bypass=0.01 μF , Pin 7 to 1) BW=10Hz~100kHz	-	100	-	μV_{RMS}

REFERENCE PART

(Unless otherwise Specified : $V_{IN}=V_{O(TYP)}+1$, $I_{OUT}=100\mu A$)

CHARACTERISTIC	SYMBOL	TEST CONDITION	MIN.	TYP.	MAX.	UNIT
Reference Voltage	V_{REF1}		1.22	1.235	1.25	V
	V_{REF2}	(Note 1)	1.19	-	1.27	V
Feed Back Pin Bias Current	I_{FB}		-	20	40	nA
Reference Voltage Temperature Coefficient	TCV_O		-	20	-	ppm/°C
Feed Back Pin Bias Current Temperature Coefficient	TCl_O		-	0.1	-	nA/°C

ERROR COMPARATOR PART

CHARACTERISTIC	SYMBOL	TEST CONDITION	MIN.	TYP.	MAX.	UNIT
Output Leakage Current	I_{OH}	$V_{OH}=30V$	-	0.01	1	μA
Output Low Voltage	V_{OL}	$V_{IN}=V_{O(TYP)}-0.5$, $I_{OUT}=400\mu A$	-	150	250	mV
Upper Threshold Voltage	$V_{TH(UPPER)}$		40	60	-	mV
Lower Threshold Voltage	$V_{TH(LOWER)}$		-	75	95	mV
Hysteresis	ΔV_{TH}		-	15	-	mV

KIA2951P/F

SHUTDOWN INPUT PART

CHARACTERISTIC	SYMBOL	TEST CONDITION	MIN.	TYP.	MAX.	UNIT
Input Logic Voltage	V_H	Low (Regulator ON)	-	-	0.6	V
	V_L	Low (Regulator OFF)	2.0	-	-	V
Shutdown Pin Input Current	I_{SH1}	$V_{SHUTDOWN}=2.4V$	-	30	50	μA
	I_{SH2}	$V_{SHUTDOWN}=30V$	-	450	600	μA
Regulator Output Current in Shutdown	I_{OUT}	(Note 2)	-	3	10	μA

Note1) $V_{REF} \leq V_{OUT} \leq V_{IN}-1$, $2.3 \leq V_{IN} \leq 30V$, $100\mu A \leq I_{OUT} \leq 100mA$, $T_J \leq T_{J(MAX)}$

Note2) $V_{SHUTDOWN} \leq 2V$, $V_{IN} \leq 30V$, $V_{OUT}=0$, Feed Back Pin to V_{TAB}

KIA2951P/F

QUIESCENT CURRENT

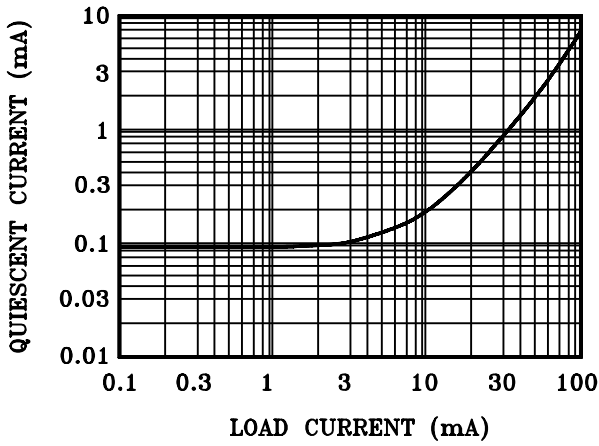

DROPOUT CHARACTERISTICS

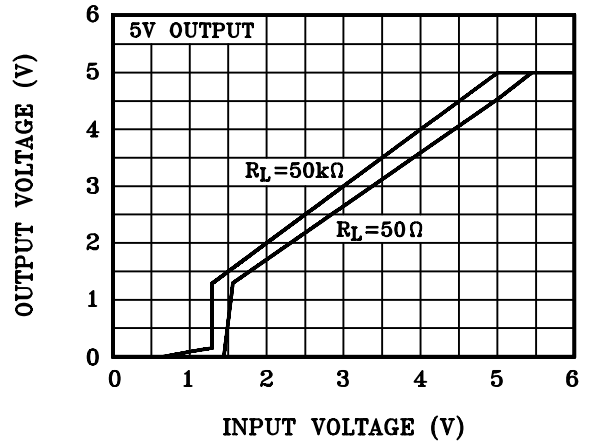

INPUT CURRENT

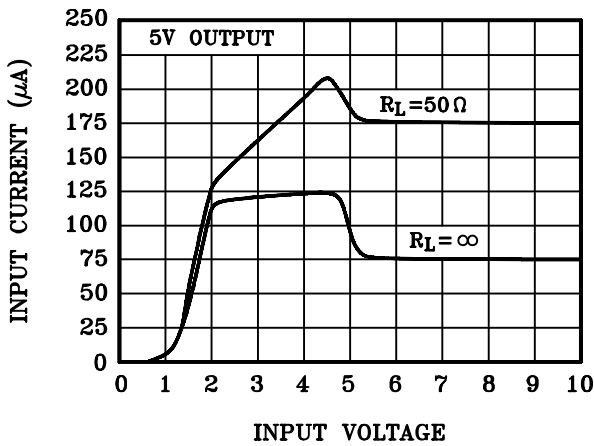

INPUT CURRENT

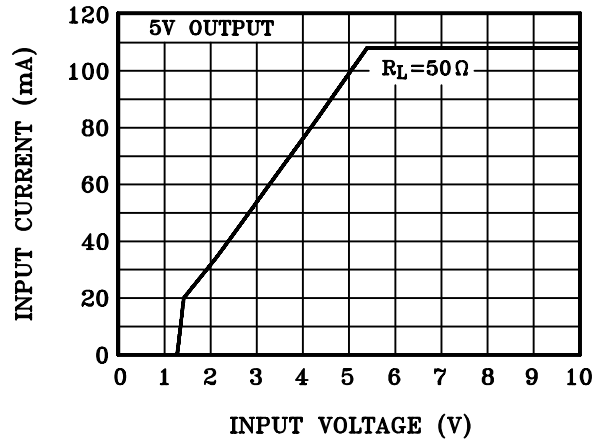

OUTPUT VOLTAGE VS. TEMPERATURE OF 3 REPRESENTATIVE UNITS

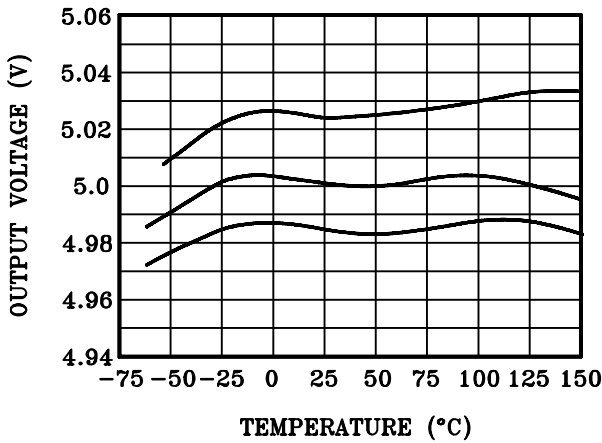

QUIESCENT CURRENT

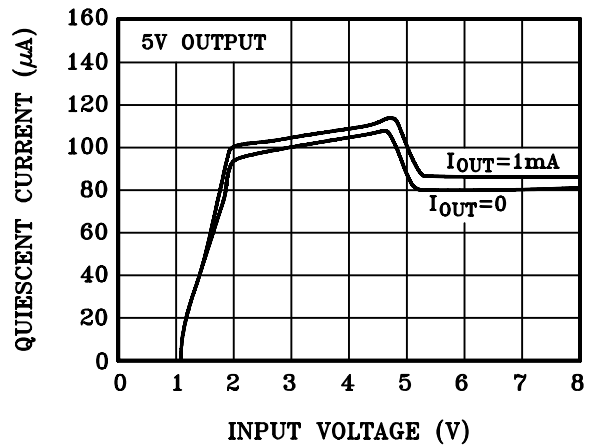

KIA2951P/F

QUIESCENT CURRENT

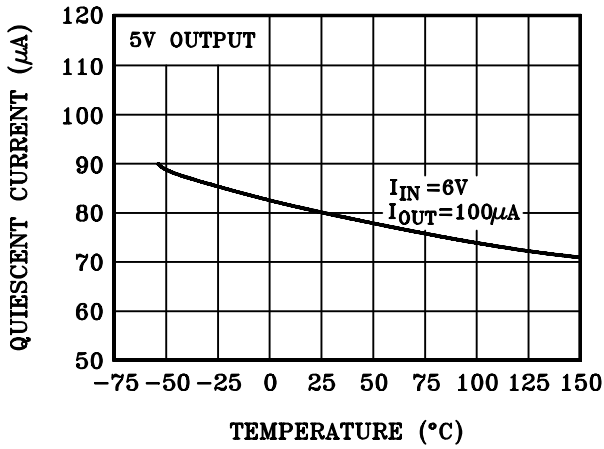

QUIESCENT CURRENT

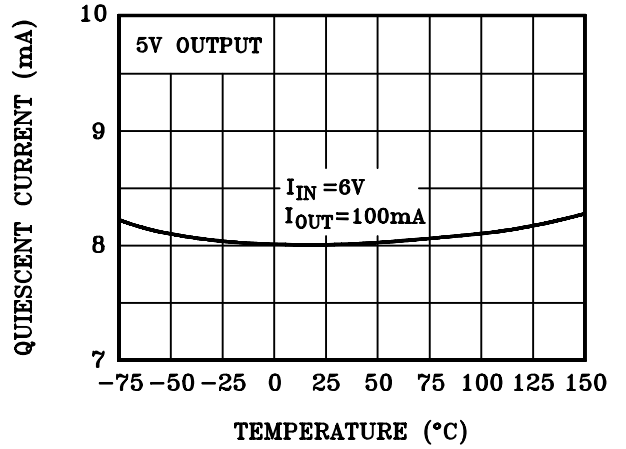

QUIESCENT CURRENT

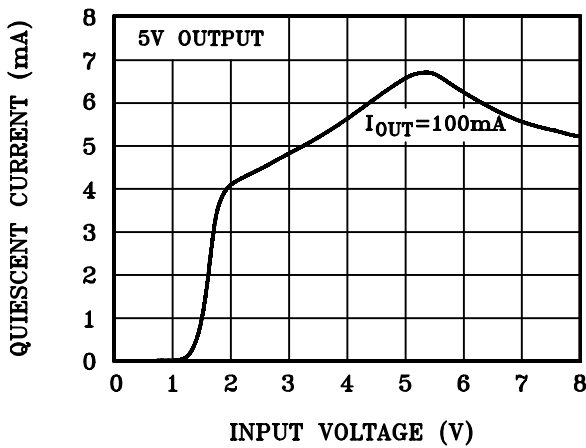

SHORT CIRCUIT CURRENT

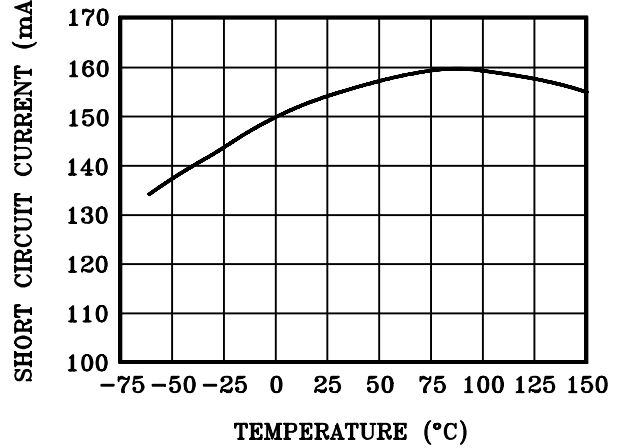

DROPOUT VOLTAGE

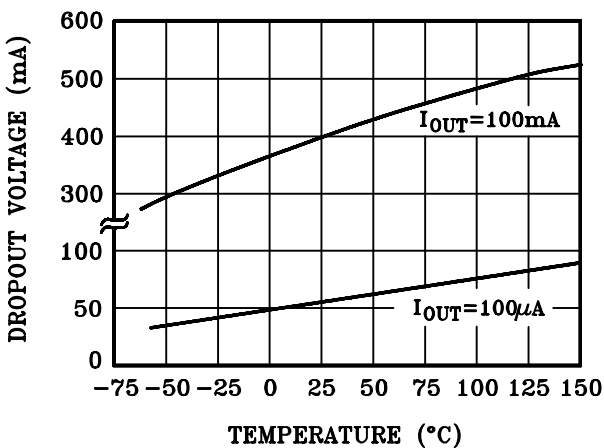

DROPOUT VOLTAGE

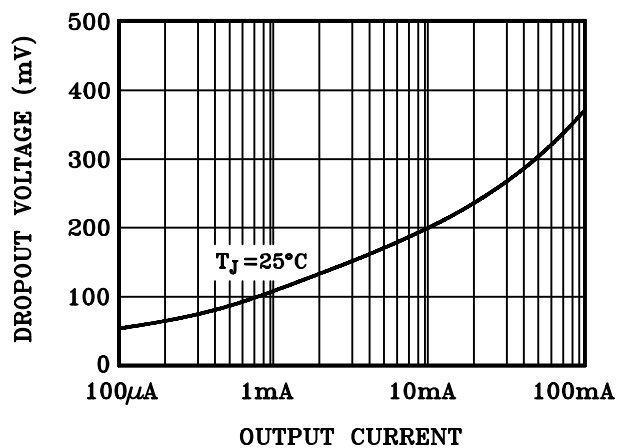

KIA2951P/F

MINIMUM OPERATING VOLTAGE

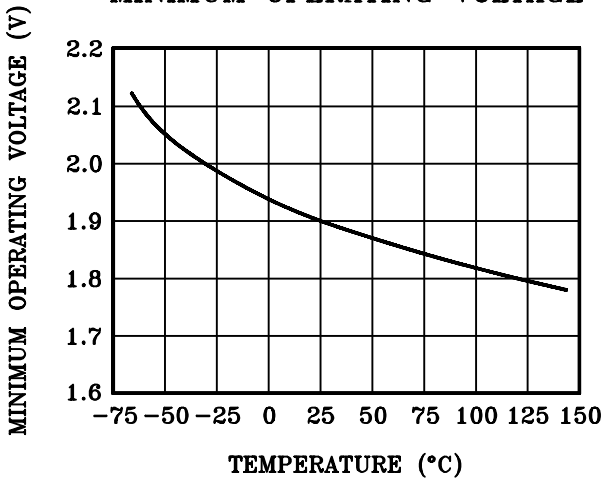

FEEDBACK BIAS CURRENT

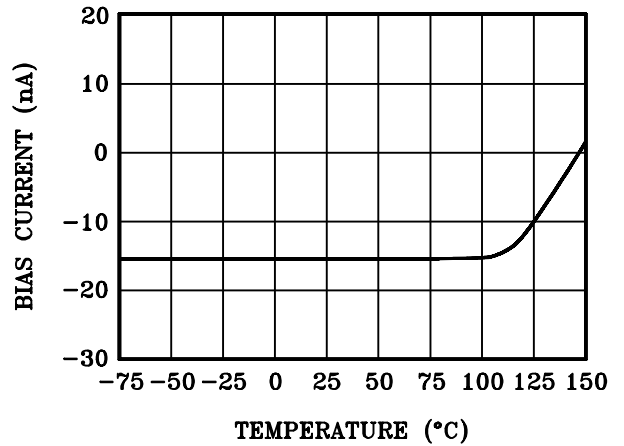

FEEDBACK PIN CURRENT

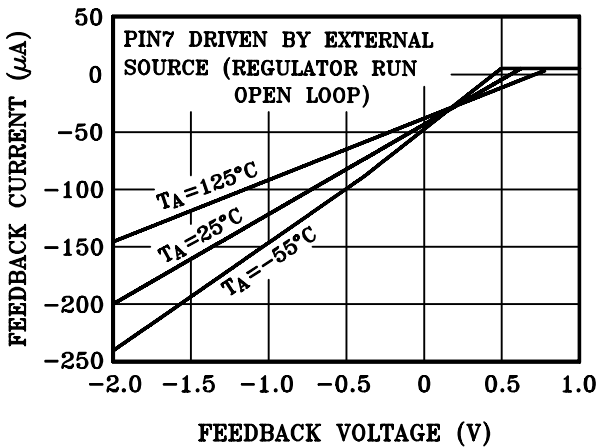

ERROR COMPARATOR OUTPUT

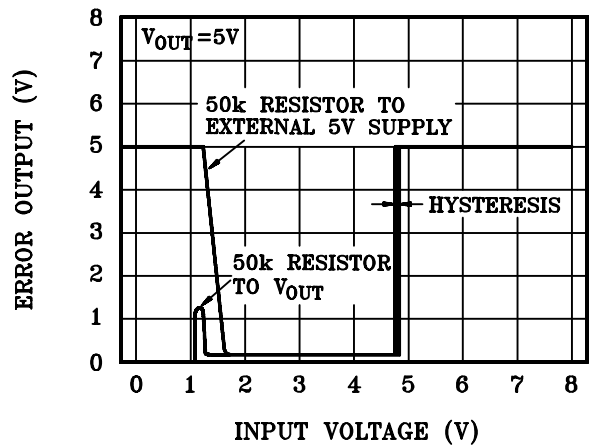

COMPARATOR SINK CURRENT

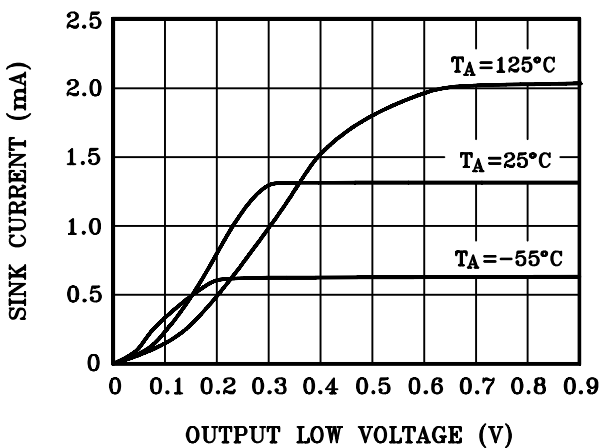

LINE TRANSIENT RESPONSE

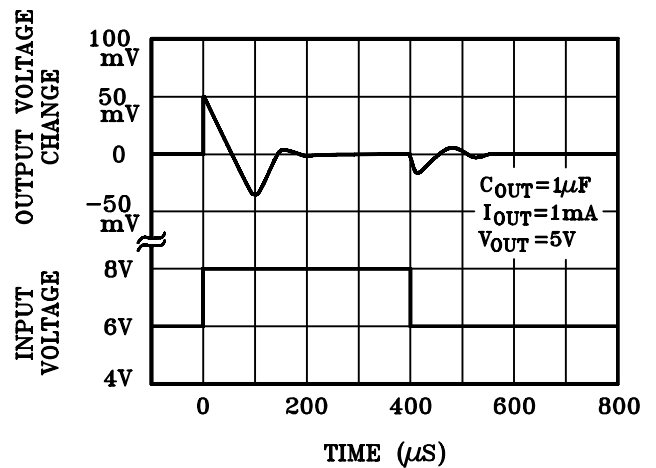

KIA2951P/F

LOAD TRANSIENT RESPONSE

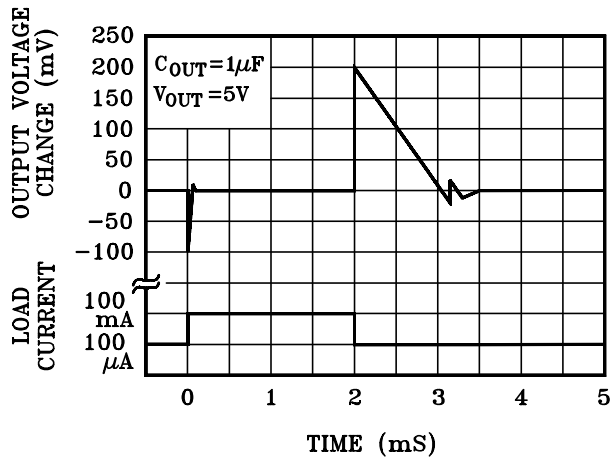

LOAD TRANSIENT RESPONSE

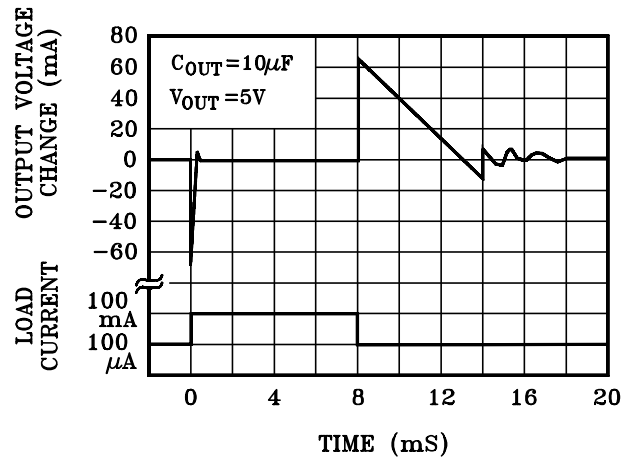

ENABLE TRANSIENT

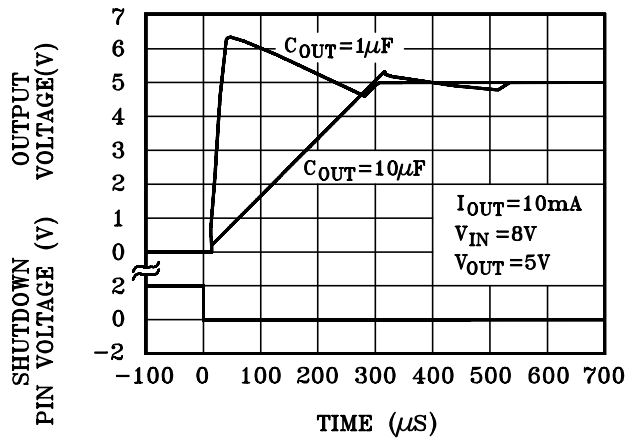

OUTPUT IMPEDANCE

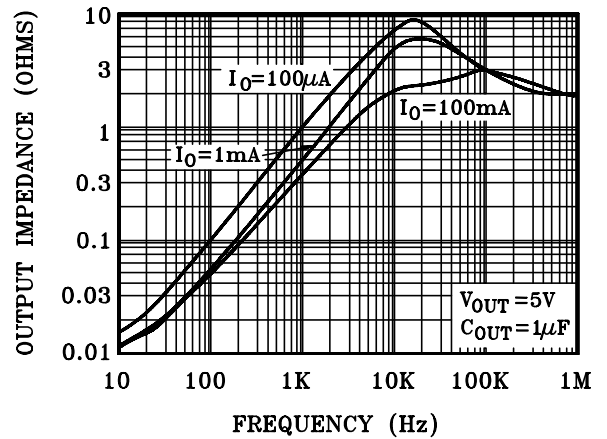

RIPPLE REJECTION

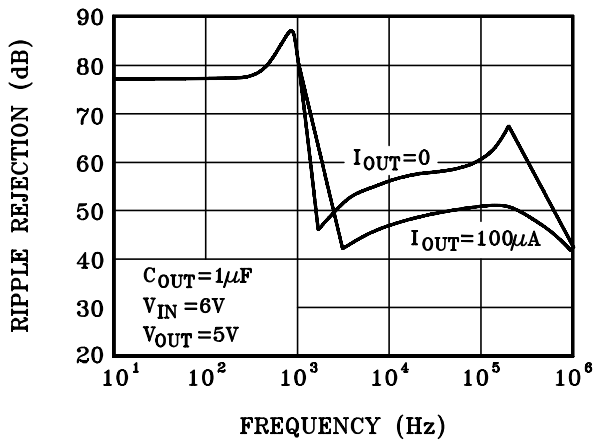

RIPPLE REJECTION

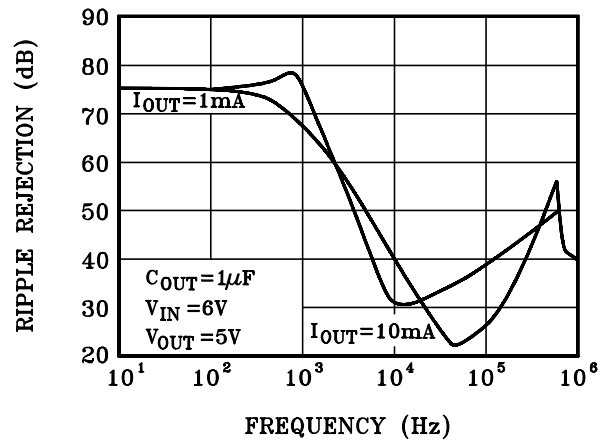

KIA2951P/F

RIPPLE REJECTION

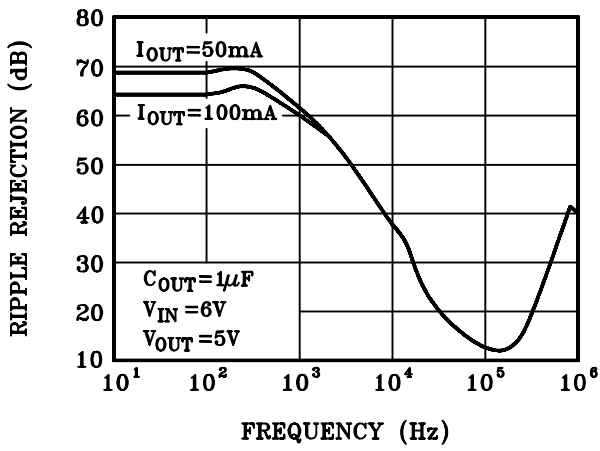

OUTPUT NOISE

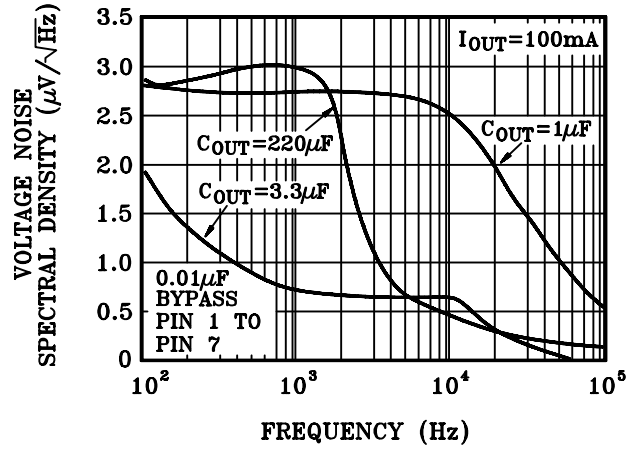

DIVIDER RESISTANCE

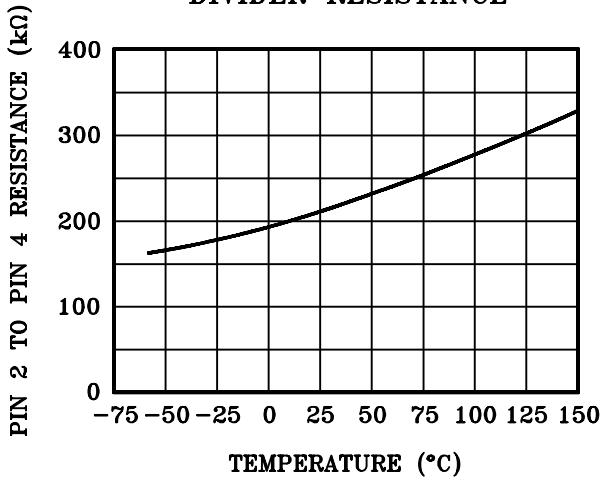

SHUTDOWN THRESHOLD VOLTAGE

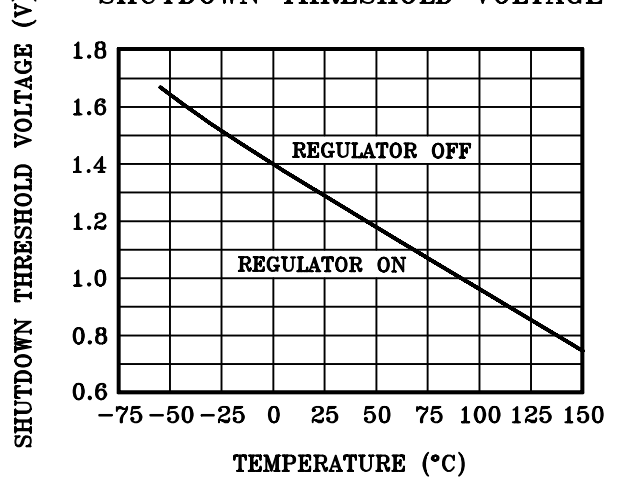

LINE REGULATION

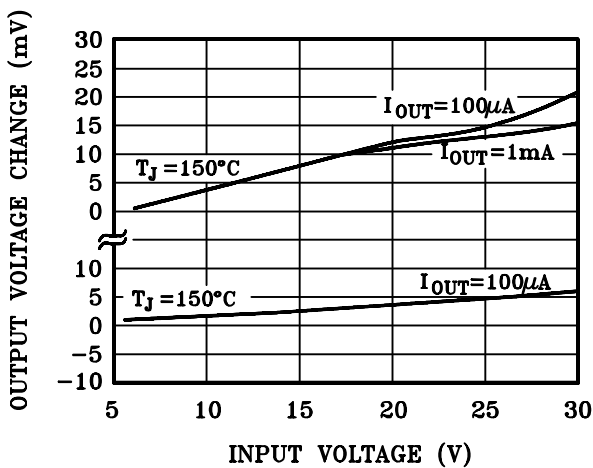

MAXIMUM RATED OUTPUT CURRENT

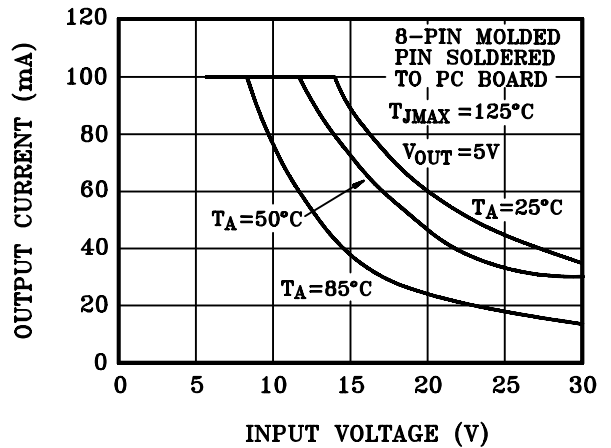

KIA2951P/F

