

## Technical Data Sheet

### 2.75 ×5.25mm Silicon PIN Photodiode

---

#### **PD638B**

#### Features

- Fast response times
- High photo sensitivity
- Small junction capacitance
- Pb free

#### Descriptions

PD638B is a high speed and sensitive PIN photodiode in a flat side view plastic package. The epoxy package itself is an IR filter , spectrally matched to IR emitter.



#### Applications

- High speed photo detector
- Camera
- Optoelectronic switch
- VCRs , Video camera

#### Device Selection Guide

LED Part No.	Chip	Lens Color
	Material	
PD	Silicon	Black

**Package Dimensions**

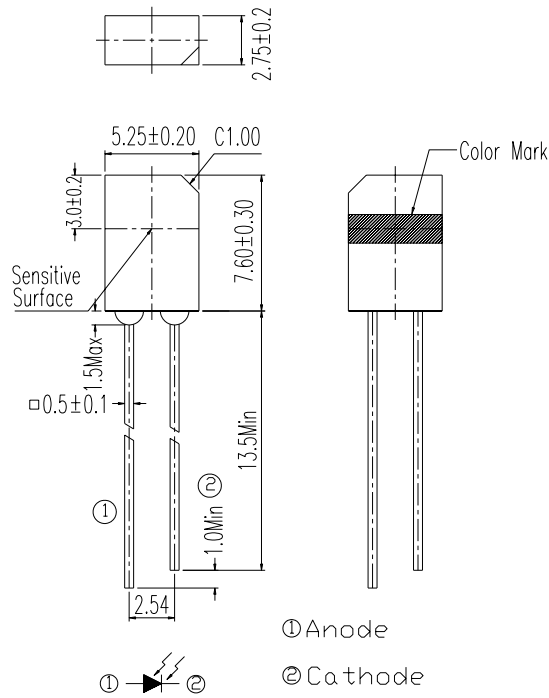

- Notes:** 1.All dimensions are in millimeters  
 2.Tolerances unless dimensions ±0.25mm

**Absolute Maximum Ratings (Ta=25°C)**

Parameter	Symbol	Rating	Units
Reverse Voltage	V <sub>R</sub>	32	V
Power Dissipation	P <sub>d</sub>	150	mW
Lead Soldering Temperature	T <sub>sol</sub>	260	°C
Operating Temperature	T <sub>opr</sub>	-40 ~ +85	°C
Storage Temperature	T <sub>stg</sub>	-40 ~ +85	°C

**Notes:** \*1:Soldering time ≤ 5 seconds.

**Electro-Optical Characteristics (Ta=25°C)**

Parameter	Symbol	Condition	Min.	Typ.	Max.	Units
Rang of Spectral Bandwidth	$\lambda_{0.5}$	-----	840	---	1100	nm
Wavelength of Peak Sensitivity	$\lambda_p$	-----	---	940	---	nm
Open-Circuit Voltage	$V_{OC}$	Ee=5m W/cm <sup>2</sup> $\lambda_p=940nm$	---	0.35	---	V
Short- Circuit Current	$I_{SC}$	Ee=1m W/cm <sup>2</sup> $\lambda_p=940nm$	---	18	---	$\mu A$
Reverse Light Current	$I_L$	Ee=1m W/cm <sup>2</sup> $\lambda_p=940nm$ $V_R=5V$	10.2	18	---	
Dark Current	$I_d$	Ee=0m W/cm <sup>2</sup> $V_R=10V$	---	5	30	nA
Reverse Breakdown	$BV_R$	Ee=0m W/cm <sup>2</sup> $I_R=100 \mu A$	32	170	---	V
Total Capacitance	$C_t$	Ee=0m W/cm <sup>2</sup> $V_R=3V$ $f=1MHZ$	---	25	---	pF
Rise/Fall Time	$t_r/t_f$	$V_R=10V$ $R_L=1K \Omega$	---	50/50	---	nS

**Typical Electro-Optical Characteristics Curves**

Fig.1 Power Dissipation vs. Ambient Temperature

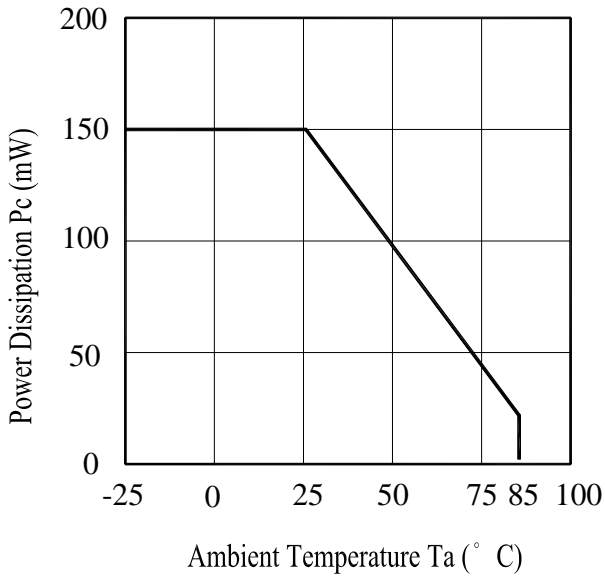

Fig.2 Spectral Sensitivity

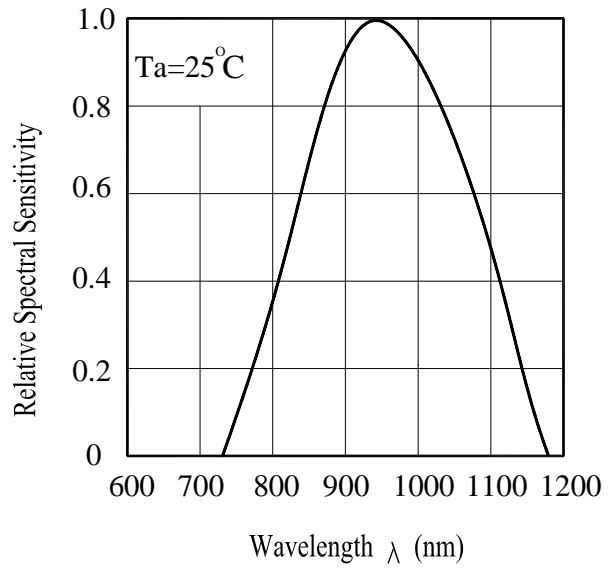

Fig.3 Dark Current vs. Ambient Temperature

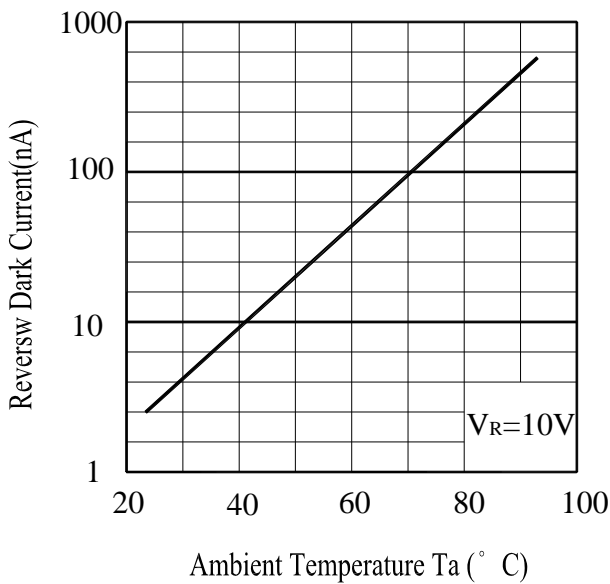
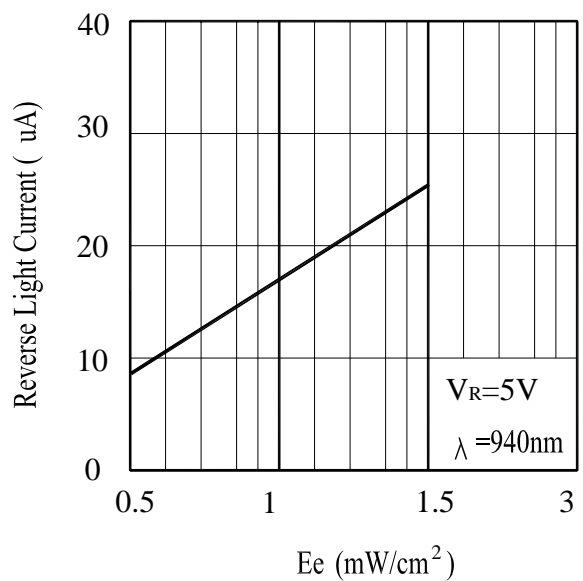

Fig. 4 Reverse Light Current vs. Ee



**Typical Electro-Optical Characteristics Curves**

Fig.5 Terminal Capacitance vs. Reverse Voltage

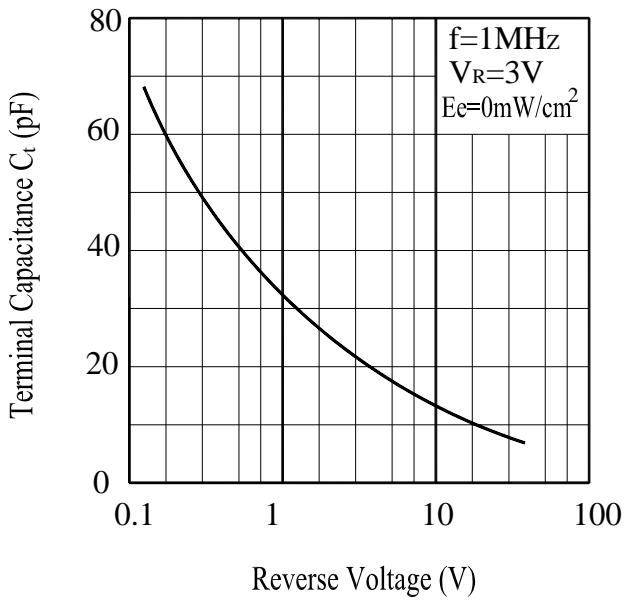
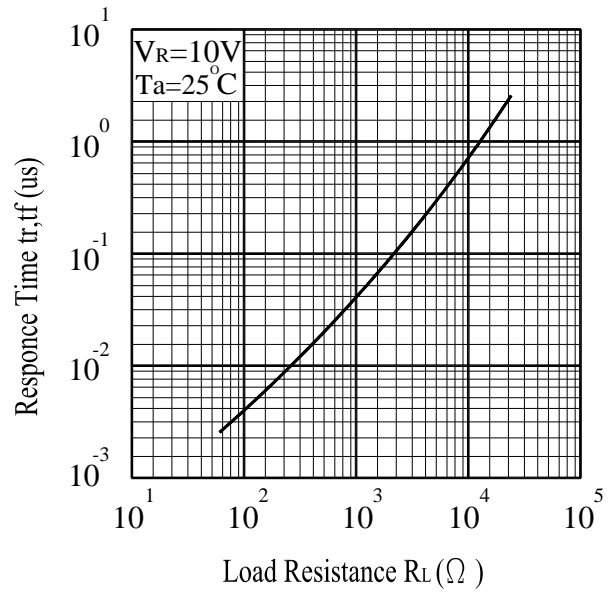

Fig.6 Response Time vs. Load Resistance



**Reliability Test Item And Condition**

The reliability of products shall be satisfied with items listed below.

Confidence level : 90%

LTPD : 10%

NO.	Item	Test Conditions	Test Hours/ Cycles	Sample Sizes	Failure Judgement Criteria	Ac/R e
1	Solder heat	TEMP. : 260°C±5°C	10secs	22pcs	$I_L \leq L \times 0.8$  L : Lower  Specification Limit	0/1
2	Temperature Cycle	H : +100°C    15mins ↑ 5mins ↓ L : -40°C    15mins	50Cycles	22pcs		0/1
3	Thermal Shock	H : +100°C    5mins ↑ 10secs ↓ L : -10°C    5mins	50Cycles	22pcs		0/1
4	High Temperature Storage	TEMP. : +100°C	1000hrs	22pcs		0/1
5	Low Temperature Storage	TEMP. : -40°C	1000hrs	22pcs		0/1
6	DC Operating Life	$V_R=5V$	1000hrs	22pcs		0/1
7	High Temperature/ High Humidity	85°C / 85% R.H	1000hrs	22pcs		0/1



**PD638B**

## Packing Quantity Specification

1.500PCS/1Bag , 6Bags/1Box

2.10Boxes/1Carton

## Label Form Specification

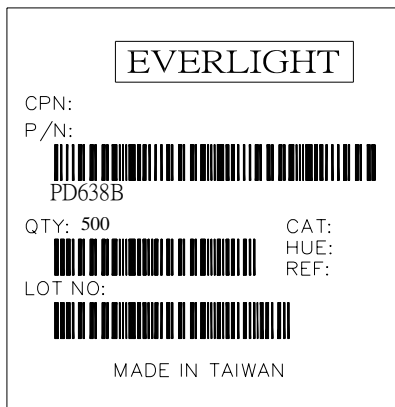

CPN: Customer's Production Number

P/N : Production Number

QTY: Packing Quantity

CAT: Ranks

HUE: Peak Wavelength

REF: Reference

LOT No: Lot Number

MADE IN TAIWAN: Production Place

## Notes

1. Above specification may be changed without notice. EVERLIGHT will reserve authority on material change for above specification.
2. When using this product, please observe the absolute maximum ratings and the instructions for using outlined in these specification sheets. EVERLIGHT assumes no responsibility for any damage resulting from use of the product which does not comply with the absolute maximum ratings and the instructions included in these specification sheets.
3. These specification sheets include materials protected under copyright of EVERLIGHT corporation. Please don't reproduce or cause anyone to reproduce them without EVERLIGHT's consent.

**EVERLIGHT ELECTRONICS CO., LTD.**

Office: No 25, Lane 76, Sec 3, Chung Yang Rd,  
Tucheng, Taipei 236, Taiwan, R.O.C

Tel: 886-2-2267-2000, 2267-9936

Fax: 886-2267-6244, 2267-6189, 2267-6306

<http://www.everlight.com>