



**ML8204
ML8205**

ADVANCE DATA

TONE RINGER

- DESIGNED FOR TELEPHONE BELL REPLACEMENT
- LOW CURRENT DRAIN
- SMALL SIZE "MINIDIP" PACKAGE
- ADJUSTABLE 2-FREQUENCY TONE
- ADJUSTABLE WARBLING RATE
- BUILT-IN HYSTERESIS PREVENTS FALSE TRIGGERING AND ROTARY DIAL "CHIRPS"
- EXTERNAL TRIGGERING OR RINGER DISABLE (ML8204)
- ADJUSTABLE FOR REDUCED SUPPLY INITIATION CURRENT (ML8205)
- TELEPHONE SET TONE RINGERS
- EXTENSION TONE RINGER MODULES
- ALARMS OR OTHER ALERTING DEVICES

The circuit. The oscillator frequencies can be adjusted over a wide range by selection of external components. One oscillator, normally operated at a low frequency (f_L), causes the second oscillator to alternate between its nominal frequency (f_{H1}), and a related higher frequency (f_{H2}). The resulting output is a distinctive "warbling" tone. The output amplifier will drive either a transformer coupled loudspeaker or a piezo-ceramic transducer. The device can be powered from a telephone line or a fixed d.c. supply. The power supply control circuit has built-in hysteresis to prevent false triggering and rotary dial "chirps". The ML8204 can be triggered externally under logic control. The ML8205 has provision for adjustment of the power supply initiation current.

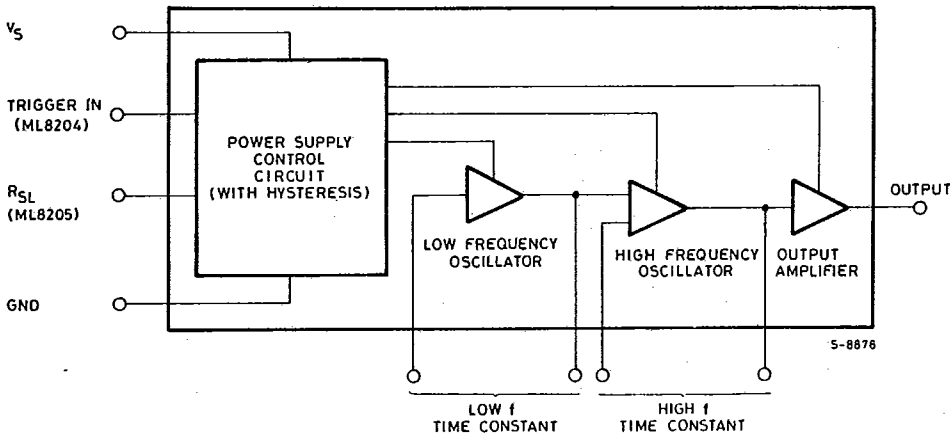


Minidip Plastic

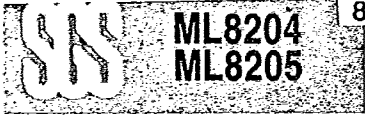
ORDERING NUMBERS: ML8204AE
ML8205AE

The ML8204/ML8205 tone ringers are monolithic devices, each incorporating two oscillators, an output amplifier and a power supply control

BLOCK DIAGRAM



This is advanced information on a new product now in development or undergoing evaluation. Details are subject to change without notice.

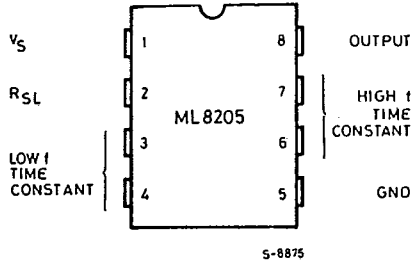
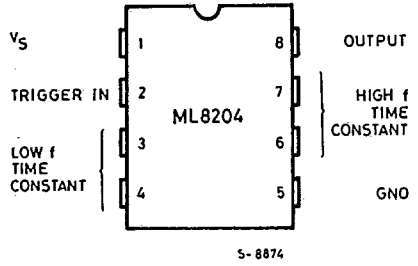


ABSOLUTE MAXIMUM RATINGS *

V_s	Supply voltage - GND	30	V
T_{op}	Operating temperature	-45 to 65	°C
T_{stg}	Storage temperature (E package)	-65 to 150	°C
P_{tot}	Total power dissipation (E package) *	400	mW

* Exceeding these ratings may cause permanent damage. Functional operation under these conditions is not implied.
 • Derate 6.3mW/°C above 25°C. All leads soldered to PC board.

CONNECTION DIAGRAMS
(Top view)



THERMAL DATA

$R_{th-jamb}$	Thermal resistance junction-ambient	max	6.3	mW/°C
---------------	-------------------------------------	-----	-----	-------



ELECTRICAL CHARACTERISTICS (All voltages referenced to GND unless otherwise noted
 $T_{amb} = 25^{\circ}C$)

Parameter	Test Conditions	Min.	Typ.	Max.	Unit	
V_S	Operating supply voltage			29	V	
V_{SI}	Supply initiation voltage (1)	Trigger in open circuit (ML8204)	17	19	21	V
V_{SUS}	Sustaining voltage (2)		9.7	11	12	V
I_{SI}	Supply initiation current	No load $V_S = V_{SI}$ $R_{SL} = 6.8K\Omega$ (ML8205)	1.4	2.5	4.2	mA
I_{SUS}	Sustaining current	No load $V_S = V_{SUS}$	0.7	1.2		mA
V_{TR}	Trigger voltage (3)		10.5	11		V
I_{TR}	Trigger current (3)		10	20	1000 (5)	μA
V_{DIS}	Disable voltage (4)			0.4	0.8	V
I_{DIS}	Disable current (4)		-40	-50		μA
V_O	Output voltage	No load $V_S = 21V$	17	19	21	V
f_o	Oscillator frequency tolerance	Component tolerance excluded			± 7	%

- Notes: (1) V_{SI} is the value of supply voltage which must be exceeded to trigger oscillation.
 (2) V_{SUS} is the value of supply voltage required to maintain oscillation.
 (3) V_{TR} and I_{TR} are the conditions applied to Trigger In to start oscillation for $V_{SUS} \leq V_S \leq V_{SI}$.
 (4) V_{DIS} and I_{DIS} are the conditions applied to Trigger In to inhibit oscillation for $V_{SI} < V_S$.
 (5) Trigger Current must be limited to this value externally.

Fig. 1a - Supply current vs. supply voltage (No load)

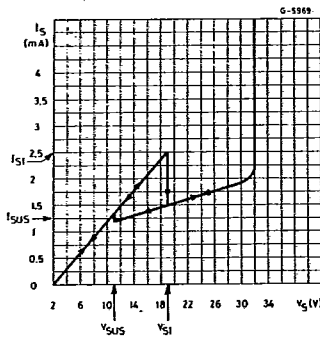
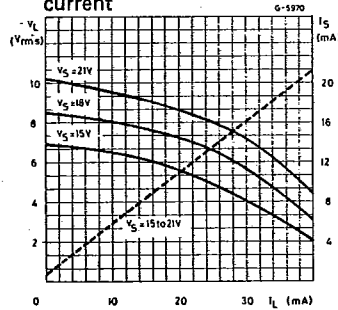


Fig. 1b - Load voltage and supply current vs. load current



ML8204
ML8205

81C 19602 D T-75-07-11

FUNCTIONAL DESCRIPTION

The M8204/ML8205 Tone Ringers are primarily intended for use as replacements for the mechanical bell in telephone sets. Each incorporates two oscillators, an output amplifier and a power supply control circuit. The devices can be powered directly from the telephone line using the a.c. ringing voltage, or they may be powered from a separate d.c. supply. The output amplifier is capable of driving a wide range of load impedances when powered from a low impedance supply. The power supply control circuit provides the hysteresis required to ensure positive triggering of the device and to prevent transient triggering due to dial pulsing.

As the power supply voltage to the ML8204/ML8205 is increased up to the supply initiation voltage (V_{SI}), the supply current also increases up to I_{SI} . When V_{SI} is exceeded, oscillation begins and the static power supply current decreases (see Fig. 2a). The low frequency oscillator (LFO) oscillates at a rate (f_L) controlled by an external resistor and capacitor. The frequency can be determined using the relation $f_L = 1/(1.234RC)$ where R is the value of the resistor connected between pins 3 and 4, and C is the value of the capacitor connected between pin 3 and ground.

The output of the LFO is internally connected to the switching threshold circuitry of the high frequency oscillator (HFO). When the output of the LFO is high, the HFO oscillates at its nominal rate (f_{H1}), described by the relation $f_{H1} = 1/(1.515RC)$ where R is the value of the resistor connected between pins 6 and 7, and C is the value of the capacitor connected between pin 6 and ground. When the output of the LFO is low, the HFO oscillates at a higher rate (f_{H2}) described by the relation $f_{H2} = 1.25f_{H1}$. Thus the LFO sets the warbling rate: the rate at which the HFO switches between the two tone frequencies f_{H1} and f_{H2} . Oscillation continues until the supply voltage decreases below the sustaining voltage (V_{SUS}). At this point, the power supply current undergoes a step increase (from I_{SUS}), and then ramps down in accordance with the supply voltage.

In normal applications, Trigger in (pin 2) of the ML8204 is left open circuit. This pin allows external triggering of oscillation of the ML8204 at

supply voltages in the range $V_{SUS} \leq V_S \leq V_{SI}$. To do so, a voltage at least equal to the minimum trigger voltage (V_{TR}) must be applied to pin 2.

Triggering the device is accomplished by sourcing a minimum current (I_{TR}) into pin 2. This current must be limited to prevent damage to the triggering circuit. Tone ringer oscillation may also be inhibited at supply voltages in the range $V_{SI} < V_S \leq V_{S(max)}$ by applying a maximum disable voltage (V_{DIS}) to pin 2. Disabling is accomplished by sinking a minimum current (I_{DIS}) out of pin 2. (See Applications Section for details on the operation and use of the Trigger in pin.)

The ML8205 requires the connection of a resistor, R_{SL} , to program the slope of its supply current versus supply voltage characteristic prior to triggering ($V_S \leq V_{SI}$). This in turn determines the maximum supply initiation current (I_{SI} drawn at the initiation voltage (V_{SI})). Programming is accomplished by connecting a slope determining resistor, R_{SL} , between pin 2 and ground. The value of I_{SI} varies inversely with the value of R_{SL} . This feature can be used to control effective impedance presented to the telephone line by the ringer circuit. (See Applications section for detailed description on the operation and use of the R_{SL} pin.)

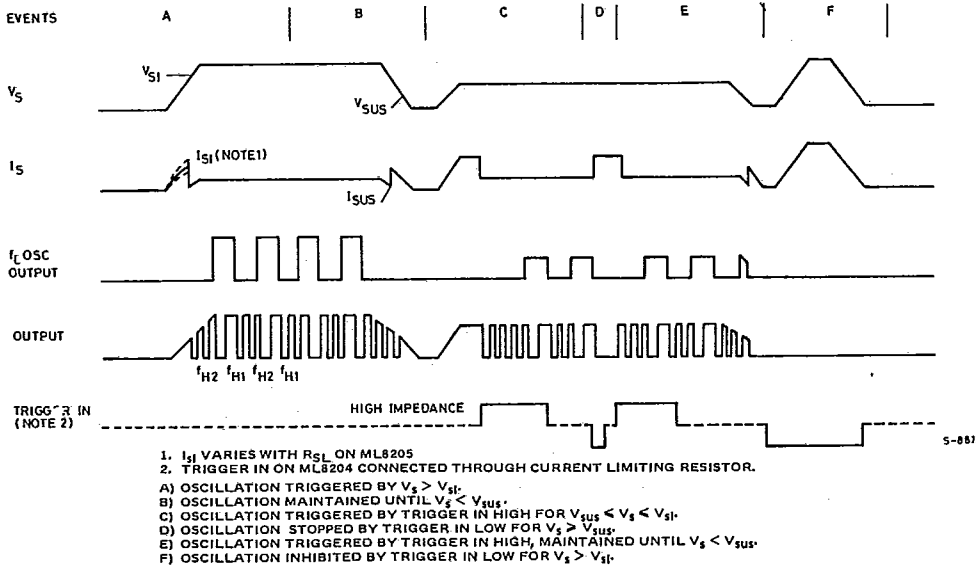
The output amplifier of the ML8204/ML8205 is capable of driving a wide range of load impedances when driven from a low source impedance power supply. When the device is powered from a telephone line, load impedance should be kept fairly high (800Ω or greater) to prevent power supply regulation problems. A transformer is thus required for driving loudspeakers as is an output coupling capacitor. Piezo-ceramic transducers may be driven directly. However, the tone frequencies f_{H1} and f_{H2} must normally be set higher (around 2KHz) to ensure that the transducer delivers sufficient acoustic power. (Suitable piezo-ceramic transducers typically have maximum efficiency around 2KHz). It is also necessary to connect a zener diode in parallel with the transducer to limit voltage surges generated by the transducer during mechanical shocks.

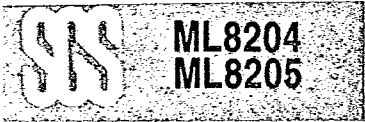


TABLE 1

PIN	PIN FUNCTION	DESCRIPTION
1	V _{SS}	Positive power supply.
2	Trigger in	ML8204 - Oscillator external trigger/inhibit pin (Must be connected through a current limiting resistor when used.)
	R _{SL}	ML8205 - Initiation Current (I _{SI}) programming pin. (Must be connected.)
3	Low f Time Constant	Low Frequency Time Constant adjustment pins. Used to set frequency at which high frequency oscillator switches f1 (by connection of appropriate resistor and capacitor. See Fig. 3)
5	GND	Negative power supply.
6	High f Time Constant	High Frequency Time Constant adjustment pins. Used to set nominal tone output frequency (f _{H1}) (by connection of appropriate resistor and capacitor. See Fig. 3)
8	Output	Tone Output. (Must be capacitively coupled for transformer coupled or resistive loads.)

Fig. 2 - ML8204/ML8205 timing diagram





APPLICATIONS

Typical Telephone or Extension Tone Ringer Circuit

The circuit shown in Fig. 3 illustrates the use of the ML8204/8205 devices in a typical telephone or extension tone ringer application. The a.c. ringing voltage appears across the TIP and RING inputs of the circuit and is attenuated by capacitor C₁ and resistor R₁. C₁ also provides isolation from d.c. voltages on the line. After full wave rectification by the diode bridge BR₁, the waveform is filtered by capacitor C₄ to provide a d.c. supply for the tone ringer chip. As this voltage exceeds the initiation voltage, V_{SI}, oscillation starts. With the components shown, the output frequency chops between 512Hz (f_{H1}) and 640Hz (f_{H2}) at a 10Hz (f_L) rate. The loud-speaker load is coupled through a 1300Ω to 8Ω transformer. While the output impedance of the ML8204 is quite low, the load impedance must be kept fairly high. This is to prevent d.c. power supply regulation problems due to high source impedance of the telephone line and coupling components C₁ and R₁. The output coupling

capacitor C₅ is required with transformer coupled loads. The value shown (0.22μF) presents a high enough impedance at the nominal ringing frequency to allow connection of fairly low impedance loads without upsetting the supply regulation. If the load impedance is large enough, then the value of this capacitor can be increased to couple more power to the load without upsetting the power supply to the ML8204. Potentiometer P₁, is used to adjust the audio amplitude and resistor R₄ is a current limiting resistor. Resistor R₅ is a quenching resistor used to limit back emf generated by the inductive load when ringing stops. When driving a piezo-ceramic transducer type load, the coupling capacitor C₅ is not required. However, a current limiting resistor is required as is a 29V zener diode in parallel with the transducer. This diode limits the voltage transients than can generated by mechanical shocking of a piezo-ceramic transducer. The electrical characteristics shown in Table 2 indicate typical performance of this circuit. The incoming ringing voltage and frequency are determined by the telephone system.

Fig. 3 - Typical tone ringer circuit

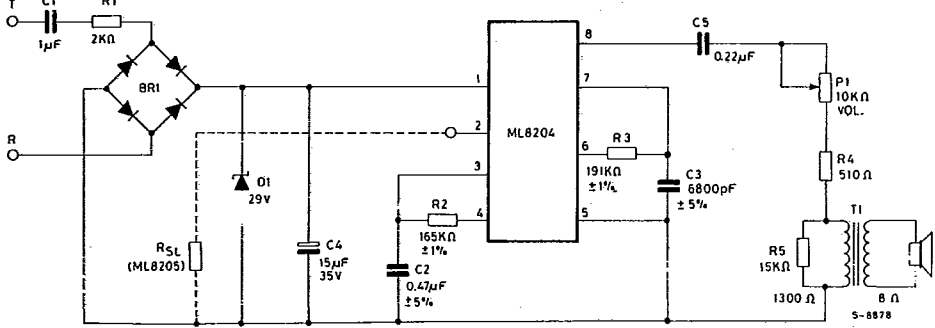
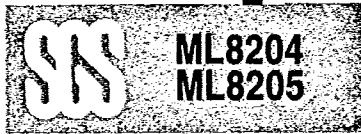


TABLE 2 - TYPICAL ELECTRICAL CHARACTERISTICS OF TONE RINGER CIRCUIT (FIG. 3)

Parameters	Min.	Typ.	Max.	Unit	Parameters	Min.	Typ.	Max.	Unit
Input voltage	75	88	120	V _{rms}	Output frequencies				
Input Frequency	16	20	60	Hz	f _L	9	10	11	Hz
Input Current (when ringing)	-	8	11	mArms	f _{H1}	461	512	563	Hz
Output Power (into 8 transformer coupled load)	-	40	-	mW	f _{H2}	576	640	704	Hz
					Output Voltage (Pin 8 'O' loop)	-	25	-	V _{PP}
					Output Sound Pressure	80	85	90	dBA



Use of Trigger In (Pin 2 ML8204)

Pin 2 of the ML8204 may be used to a) externally trigger oscillation for voltages in the range $V_{sus} \leq V_s \leq V_{sl}$, or b) disable ringer operation. The equivalent circuit at pin 2 is shown in Fig. 5. The ringer circuit can only oscillate when Q_1 is conducting. Normally when supply voltage V_s exceeds the supply initiation voltage (V_{sl}), base current flows into Q_1 , via D_2 and D_1 causing Q_1 to conduct. This continues until V_s is taken below the minimum sustaining voltage (V_{sus}).

The ML8204 can be made to oscillate when powered from supply voltages in the range $V_{sus} \leq V_s \leq V_{sl}$. Oscillation is ensured by forcing a

current I_{TR} ($10\mu A \leq I_{TR} \leq 1mA$) into pin 2 to provide base current to Q_1 . This requires the voltage applied to pin 2 to exceed V_{TR} where V_{TR} is the sum of the zener voltage of D_3 , the forward voltage drop of D_2 and the V_{BE} of Q_1 (typically 11V). The required current drive can be provided by connecting a resistor R_E between pin 1 and V_s (Fig. 5a); where: $20K\Omega \leq R_E \leq (V_s - 11)/10M\Omega$. To operate the ML8204 from a d.c. 12V supply, R_E should be typically 50K Ω . This mode of operation can also be used to reduce the effective value of the V_{sl} , by inserting a zener diode in series with R_E (Fig. 5b). This modifies the initiating voltage to $V_{sl(Eff)} = V_{TR} + V_Z + 10R_E$ (R_E is in M Ω).

Fig. 4 - Pin 2 input equivalent circuit

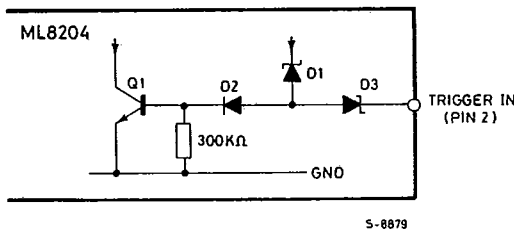


Fig. 5a - Enabling oscillation of the ML8204 for supply voltages less than V_{sl}

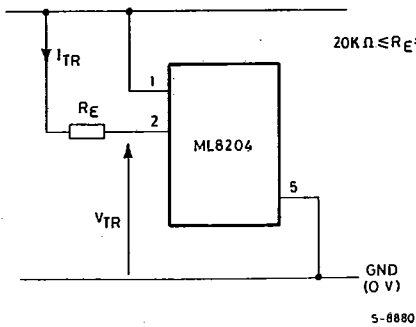
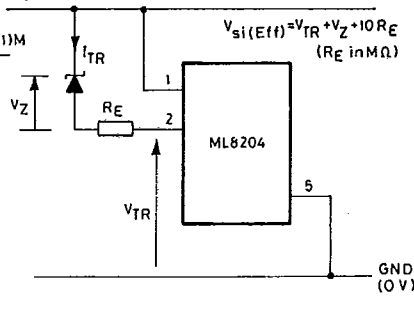
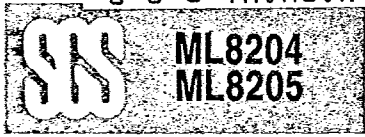


Fig. 5b - Reducing the effective value of V_{sl} for the ML8204





Oscillation of the ML8204 may be inhibited for voltages in the range $V_{s1} < V_s \leq V_{s(max)}$ by sinking the current from D_1 , starving Q_1 of base current. This is achieved by either a) grounding pin 2 (Fig. 6a), or b) applying a voltage V_{INH} via a resistor R_1 to pin 2 (Fig. 6b) to ensure that: $V_{DIS} \leq 0.8V$, and $I_{DIS} = \frac{V_{DIS} - V_{INH}}{R_1} \geq 40\mu A$.

When driven from a fixed d.c. supply, oscillation of the ML8204 may be gated on or off by CMOS or TTL logic as shown in Fig. 7a and Fig. 7b respectively.

Fig. 6 - Inhibiting oscillation of the ML8204

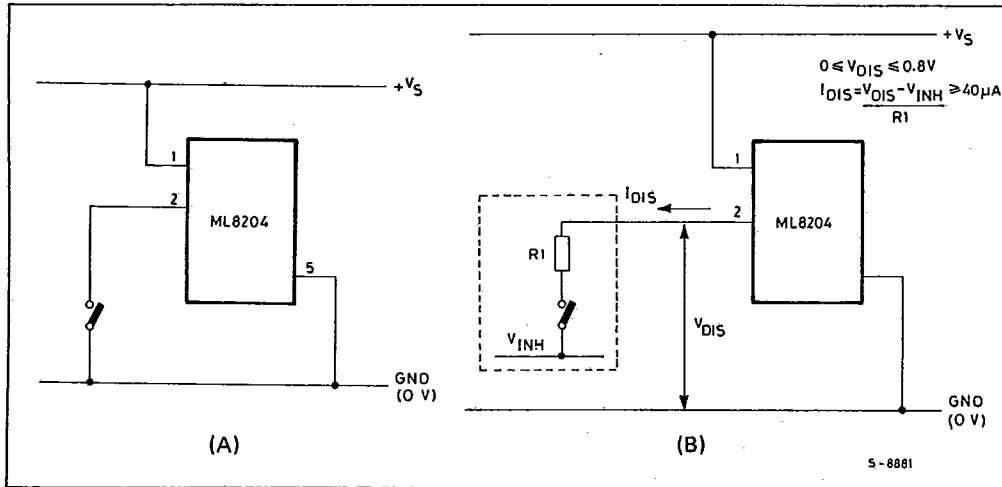
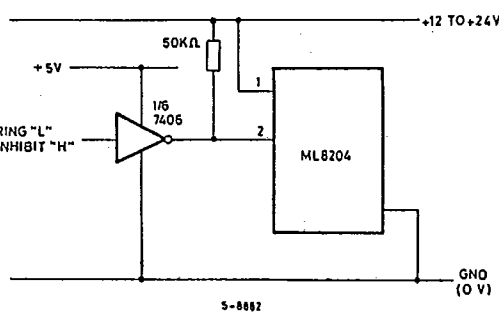
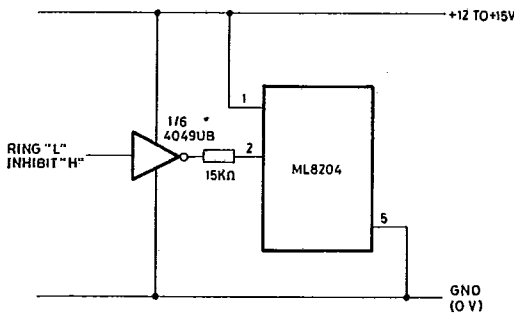
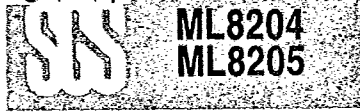


Fig. 7a - Gating the ML8204 from CMOS

Fig. 7b - Gating the ML8204 from TTL





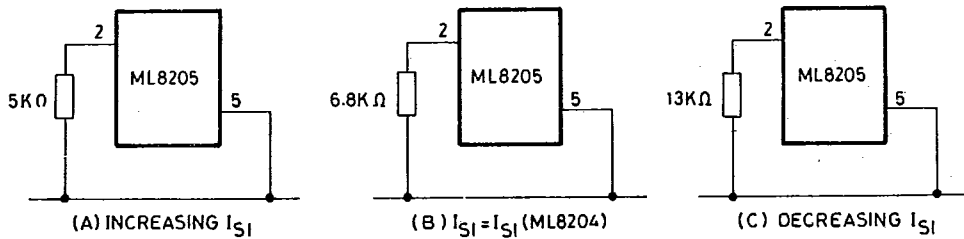
Programming the ML8205 initiation Current

Pin 2 of the ML8205 requires connection of an external resistor R_{SL} (Fig. 8), which is used to program the slope of the supply current vs. supply voltage characteristic, and hence the supply current up to the initiation voltage (V_{SI}). This initiation voltage remains constant independent of R_{SL} . The supply initiation current (I_{SI}) varies inversely with R_{SL} , decreasing for increasing values of resistance. Thus, increasing the value of R_{SL} will decrease the amount of a.c. ringing current required to trigger the device. As such, longer subscriber loops are possible since less voltage is dropped per unit length of loop wire due to the lower current level. R_{SL} can also be used to compensate for smaller a.c. line coupling capacitors (providing higher impedance)

which can be used alter the ringer equivalence number of a tone ringer circuit.

The graph in Fig. 9a illustrates the variation of supply current with supply voltage of the ML8205. Three curves are drawn to show the change in the slope of the I-V characteristic with R_{SL} . Curve B ($R_{SL} = 6.8K\Omega$) shows the I-V characteristic for the ML8204 tone ringer. Curve A is a plot with $R_{SL} = 5.0K\Omega$ and shows an increase in the current drawn up to the initiation voltage V_{SI} . The I-V characteristic after initiation remains unchanged. Curve C illustrates the effect of increasing R_{SL} to $13.0K\Omega$. Initiation current decreases but again current after triggering is unchanged. The variation of I_{SI} , with R_{SL} is illustrated in Fig. 9b.

Fig. 8 - Adjusting I_{SI} by varying R_{SL}



S-8883

Fig. 9a - I-V slope change due to R_{SL}

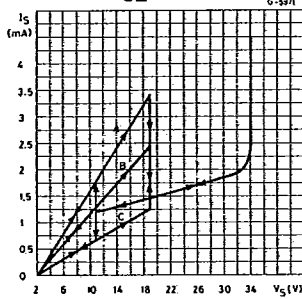
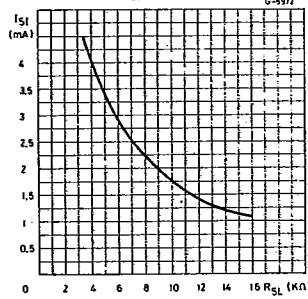
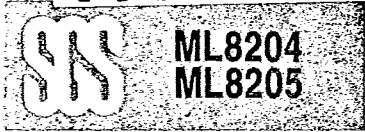


Fig. 9b - Supply initiation current (I_{SI}) vs. R_{SL}





Mitel F.C.C. Approved Tone Ringer Module Using ML8205

The Mitel tone ringer module (CM3215) using the Mitel ML8205 tone ringer chip in the circuit below (Fig. 10) has been approved by the F.C.C. (F.C.C. Reg. Number BN285B673550TN). The circuit has been given a ringer equivalence of 0.7 B. This is accomplished by increasing the value of R_{SL} to $13K\Omega$ which reduces the supply initiation current (I_{SI}). This reduction in I_{SI} allows the use of higher line coupling components ($R_1 = 8.2K\Omega$) while ensuring sufficient voltage drop between pins 1 and 5 of the ML8205 for triggering. The 5.1V zener diode D_1 presents a high impedance to low level signals on the telephone

line while allowing tone ringer powering from high level rigging voltages.

Transient Overvoltage Testing of the ML8204 Tone Ringer

The following tests were performed to investigate the ability of the ML8204 to withstand transients on its power supply rails. All tests were performed using the circuit shown in Fig. 11 with transient voltage pulses of the form shown in Fig. 12. After each application of a transient pulse, functionality of the device was checked by switching S_1 , S_2 , and S_3 to the configuration shown in Fig. 11.

Fig. 10 - F.C.C. approved tone ringer circuit

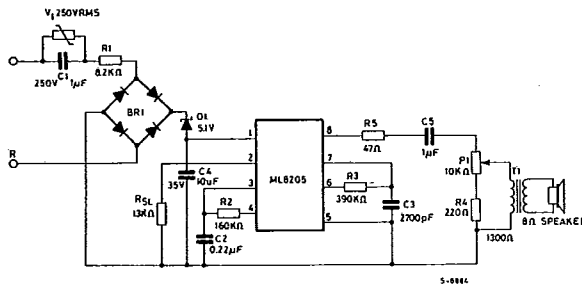
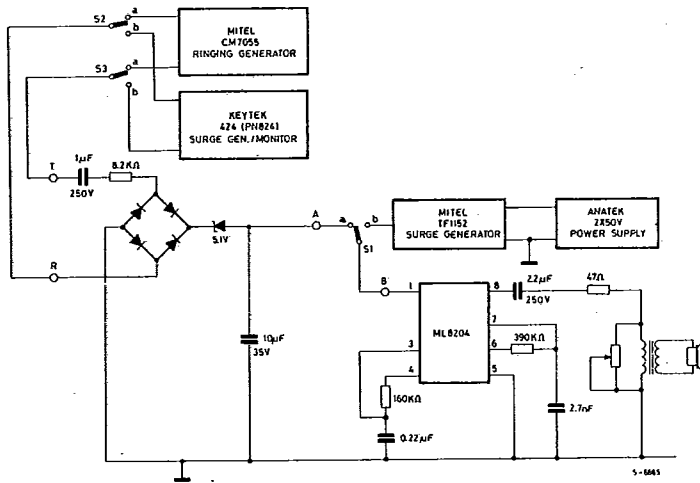
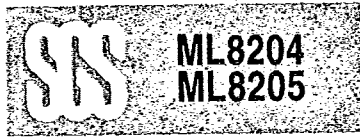


Fig. 11 - ML8204 test circuit (Power supply transients)





The device was tested in two ways by applying pulses: 1) directly into the ML8204 power supply pins, and 2) to the complete ringer circuit TIP and RING inputs. In the first case with S_1 in position "b", a series of pulses with magnitudes (V) from 30V upwards applied from the TF152 until the ML8204 failed to operate. This was repeated for 10 devices. The unloaded value of V at which the devices ceased to operate varied from 84 to 88V (V_{BK}). Subsequently a number of devices were tested by applying 70V pulses to each device. Instability was noted in some devices after 100 pulse applications. All devices ceased to function after 172 to 203 pulse applications. A further set of devices were tested with 64V pulses. All devices withstood 300 pulse applications without any sign of degradation. In the second test, with switches S_2 and S_3 in position "b" and S_1 in position "a", 800 and 1500V pulses were repeatedly applied to the TIP and RING inputs of the circuit. No degradation of the devices' operation was observed.

Single Tone Operation of the ML8204/ML8205

The ML8204/ML8205 can be made to oscillate at one or the other of its output tone frequencies f_{H1} or f_{H2} . To do so, the tone frequency determining components are connected to pins 6 and 7 as normally done. Pin 3 is used as a control input. When pin 3 is connected to V_s , the output (pin 6) will oscillate at the f_{H1} frequency. Conversely, when pin 3 is at ground, the output will oscillate at the f_{H2} frequency. The output can thus be switched between f_{H1} and f_{H2} externally by applying a control signal to pin 3. The low frequency oscillator may also be used separately by connecting the frequency determining components between pins 3 and 4 as normally done. The output is taken from pin 4. However, this is a fairly high impedance output.

Fig. 12 - Typical transient test waveform

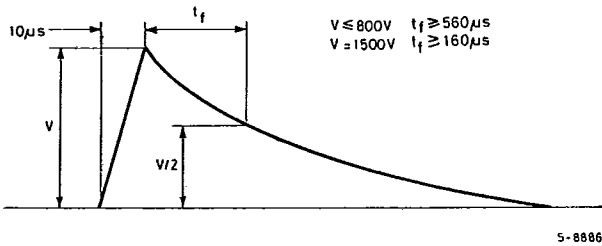
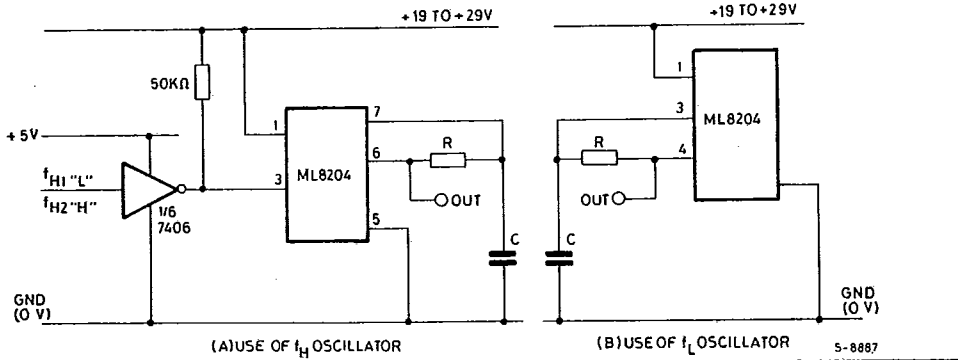
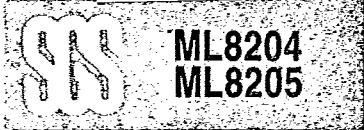


Fig. 13 - Single tone operating of ML8204/ML8205





Typical Application Circuits for use with a Piezo-electric Transducer

Feedback from a piezo-electric transducer can cause spurious oscillations on the output of a ML8204/5 tone ringer. These oscillations corrupt the normal two-tone output and change as the ringer switches off.

The oscillations occur because the piezo electric transducer resonates at its characteristic frequency. If the resonant amplitude is sufficient to pull pin 8 one bipolar threshold below pin 5 then the tone ringer may give a short spurious pulse.

This effect can be eliminated by using a bypass capacitor across the transducer as shown in Fig. 14. The size of this capacitor is obviously dependent on the piezo-electric transducer used, but a value of $0.1\mu\text{F}$ is usually sufficient.

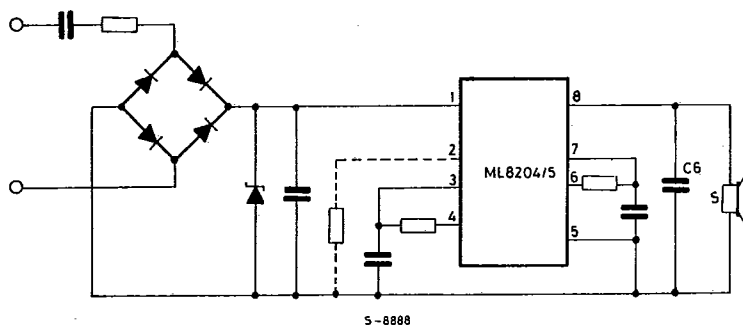
It is possible under specific conditions for a ML8204/5 tone ringer with a piezo-electric load to continue oscillating after the ringing voltage stops.

The ringer can be powered by the smoothing capacitor which is across pins 1 and 5 (see Fig. 14). This causes the device to switch off slowly and since the output frequencies shift by about a musical semitone before oscillation stops, the output can have an unpleasant tail-off.

To eliminate this, a simple monitor can be used which switches the output off when ringing stops. Fig. 16 shows a circuit which works with an ML8204. When ringing voltage is applied from the line, pin 2 is held between 2 and 10V and the device functions normally. When ringing stops, pin 2 is pulled to ground and the ML8204 switches off.

There is no enable on the ML8205 corresponding to pin 2 on the ML8204. Fig. 16 shows a circuit which does not require the enable pin. The output is switched through an NPN transistor instead. During ringing the base of the transistor is forward biased and the load is enabled. When ringing stops the transistor switches off and deactivates the load.

Fig. 14 - Typical application circuit for use with a piezo-electric transducer



$C6 = 0.1\mu\text{F}$
 S = PIEZO-ELECTRIC TRANSDUCER
 OTHER COMPONENTS SAME AS FIGURE 3

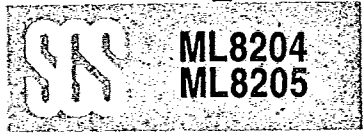
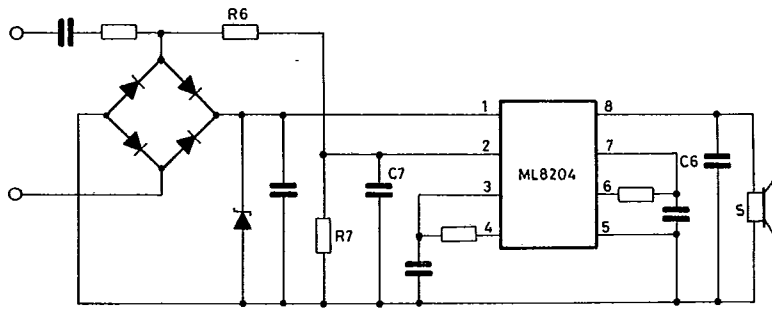
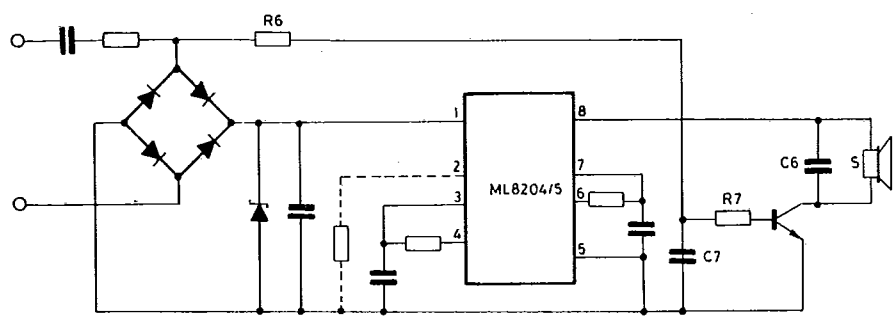


Fig. 15 - ML8204 circuit to eliminate tail-off



5-8889
C6 = 0.1μF
C7 = 4.7μF
R6 = 51KΩ
R7 = 22KΩ
S = PIEZO-ELECTRIC TRANSDUCER
OTHER COMPONENTS SAME AS FIG. 3

Fig. 16 - ML8204/5 circuit to eliminate tail-off



5-8890
C6 = 0.1μF
C7 = 4.7μF
R6 = 51KΩ
R7 = 22KΩ
S = PIEZO-ELECTRIC TRANSDUCER
OTHER COMPONENTS SAME AS FIG. 3