



## TPS4100

### FOUR CHANNEL BRIDGED OUTPUT POWER STAGE

Revision 2.5 - February 2005

#### GENERAL DESCRIPTION

The TPS4100 is a 4 channel bridged (16 power transistors) output power stage. The TPS4100 accepts 5V CMOS logic signals from a Class-T processor, such as TCD6001, to create a high fidelity 4 channel audio amplifier. The TPS4100 has been designed specifically for automotive head unit applications operating on a single 10-26V supply.

#### APPLICATIONS

- Automotive Head Units and Trunk Amplifiers
- DVD Receivers
- Multimedia Speaker Systems

#### BENEFITS

- 4-channel output stage – with integrated driver and FETs - in a single 32-pin SSIP package
- Low external component count
- Single-supply operation

#### FEATURES

- Four H-Bridge outputs
- High Efficiency
- High Power @25.0V
  - 100W<sub>sat. sq. wave</sub> @ 4Ω
- High Efficiency
  - 88% @ 100W 4Ω
- AM “Low EMI” mode with connection to appropriate Class-T controller
- Mates seamlessly with TCD6001 Digital Input Class-T controller
- Mute and Stand-By function
- Protection Modes:
  - Output Short to VPP and Ground
  - Output Short across Load
  - Load Dump Protection
  - Over-/Under-Voltage Protection
  - Over-current Protection
  - Over-temperature Protection
  - Fortuitous Open Ground



**Absolute Maximum Ratings** (Notes 1, 2)

SYMBOL	PARAMETER	Value	UNITS
V <sub>PP</sub>	Supply Voltage (V <sub>PP</sub> )	33	V
V <sub>PP</sub> <sub>MAX</sub>	Peak Supply Voltage (t <sub>≤</sub> 50ms)	60	V
V <sub>IN</sub> <sub>RANGE</sub>	Voltage Range for Input Section Pins (Note 2) Inputs (Pins 1-11)	-0.5 to 5.5	V
T <sub>STORE</sub>	Storage Temperature Range	-55 to +150	°C
I <sub>R</sub>	Repetitive Peak Output Current	12	A
T <sub>J</sub>	Maximum Junction Temperature	150	°C
P <sub>D</sub>	Total Power Dissipation (T <sub>case</sub> = 70°C)	80	W
ESD	ESD Susceptibility - Human Body Model (Note 3)	2k	V
ESD	ESD Susceptibility – Machine Model (Note 4)	200	V

Note 1: Absolute Maximum Ratings indicate limits beyond which damage to the device may occur.

See the table below for Operating Conditions.

Note 2: The input section pins (pins 1-11) should not be connected to voltages over 5.5V with respect to pins 13 and 14 (AGND). Please note that pin 12 is an output and can be damaged if a voltage is forced externally.

Note 3: Human body model, 100pF discharged through a 1.5KΩ resistor.

Note 4: Machine model, 220pF – 240pF discharged through all pins.

**Operating Conditions** (Note 5)

SYMBOL	PARAMETER	MIN.	TYP.	MAX.	UNITS
V <sub>PP</sub>	Supply Voltage (Note 5)	10	14.4	26	V
T <sub>A</sub>	Operating Free Air Temperature Range	-40	25	85	°C

Note 5: Recommended Operating Conditions indicate conditions for which the device is functional.

See Electrical Characteristics for guaranteed specific performance limits.

**Thermal Characteristics**

SYMBOL	PARAMETER	Value	UNITS
θ <sub>JC</sub>	Junction-to-case Thermal Resistance	1.0	°C/W
θ <sub>JA</sub>	Junction-to-ambient Thermal Resistance (still air)	20	°C/W

**Electrical Characteristics** (Note 6)

$T_A = 25\text{ }^\circ\text{C}$ . Unless otherwise noted, the supply voltage is  $V_{PP}=14.4\text{V}$ . See Application/Test Circuit.

SYMBOL	PARAMETER	Conditions	MIN.	TYP.	MAX.	UNITS
$I_{STBY}$	Stand-By Current	$V_{SLEEPB} < 0.15\text{V}$		100	200	$\mu\text{A}$
$V_{IL}$	Stand-By On Threshold Voltage	SLEEPB Low (amp off)			0.6	V
$V_{IH}$	Stand-By Off Threshold Voltage	SLEEPB High (amp on)	2.3			V
$V_{IL}$	Mute-On Threshold Voltage	MUTE Low			1	V
$V_{IH}$	Mute-Off Threshold Voltage	MUTE High	2.3			V
$V_{IL}$	Yn/YnB Low Threshold Voltage				0.6	V
$V_{IH}$	Yn/YnB High Threshold Voltage		2.3			V
$V_{OH}$	Fault Reporting Logic Output High Voltage	Open Drain Output	3.5			V
$V_{OL}$	Fault Reporting Logic Output Low Voltage	$R_{FAULT} = 51\text{K}\Omega$			1	V
$V_{IH}$	AM Mode On Threshold Voltage		2.3			V
$V_{IL}$	AM Mode Off Threshold Voltage				1	V
$I_{AM}$	AM Mode Pin Input Current				1	$\mu\text{A}$

Note 6: Minimum and maximum limits are guaranteed but may not be 100% tested.

**Performance Characteristics** (Note 6)

$T_A = 25\text{ }^\circ\text{C}$ . Unless otherwise noted,  $R_L = 4\Omega$ . Measurement Bandwidth = 20kHz. All specifications shown are applicable only when the TPS4100 is used in conjunction with the TCD6001 Class-T Controller. See Application/Test Circuit of TCD6001 data sheet for additional information.

SYMBOL	PARAMETER	CONDITIONS	MIN.	TYP.	MAX.	UNITS				
$P_{OUT}$	Output Power (Continuous power/ channel)	VPP=25V saturated sq. wave	95	112		W				
		VPP=25V THD+N=10%		80		W				
		VPP=25V THD+N=1%		65		W				
		VPP=20V saturated sq. wave		VPP=20V THD+N=10%	65	74		W		
				VPP=20V THD+N=1%		51		W		
				VPP=20V THD+N=1%		40		W		
				VPP=14.4V sat. sq. wave, $R_L = 2\Omega$		63		W		
				VPP=14.4V THD+N=10%, $R_L = 2\Omega$		42		W		
				VPP=14.4V THD+N=1%, $R_L = 2\Omega$		33		W		
				VPP=14.4V saturated sq. wave		35		39		W
				VPP=14.4V THD+N=10%				26		W
				VPP=14.4V THD+N=1%				21		W
$\eta$	Power Efficiency	VPP=25V, 4 x 100W sat sq wave	84	88		%				

**AM Mode** (Note 6)

$T_A = 25\text{ }^\circ\text{C}$ . Unless otherwise noted, the supply voltage is  $V_{PP}=14.4\text{V}$ ,  $R_L = 4\Omega$ . Measurement Bandwidth = 20kHz. See Application/Test Circuit.

SYMBOL	PARAMETER	CONDITIONS	MIN.	TYP.	MAX.	UNITS
$I_{OCD}$	Over-current detect		5.5			A
$P_{out}$	Output Power (Note 7)	VPP=16V, THD+N=10%	13	20		W
		VPP=14.4V, THD+N=10%		16		W

Note 7: The TPS4100 heat sinking in AM Mode must be increased (as compared to Class-T mode) to sustain the typical output numbers. This is due to the lower efficiency of Class B output stage operation.

**Protection Circuits** (Note 5)

T<sub>A</sub> = 25 °C. Unless otherwise noted, the supply voltage is V<sub>PP</sub>=14.4V.

SYMBOL	PARAMETER	CONDITIONS	MIN.	TYP.	MAX.	UNITS
OV <sub>ON</sub>	Over-voltage Threshold	Over-voltage turn on (amp muted)	27.0	30	32.5	V
OV <sub>OFF</sub>	Over-voltage Reset	Over-voltage turn off (mute off)	26.0	28.0		V
UV <sub>OFF</sub>	Under-voltage Reset	Under-voltage turn off (mute off)		9.5	10.0	V
UV <sub>ON</sub>	Under-voltage Threshold	Under-voltage turn on (amp muted)	7.8	8.1	8.6	V
OT <sub>ON</sub>	Over-Temperature Threshold	Over-temperature turn on (amp muted)	150	160	170	°C
OT <sub>OFF</sub>	Over-Temperature Reset	Over-temperature turn off (mute off)	120	130	140	°C
I <sub>OC</sub>	Over-Current Detect	Single cycle, 1kHz input ramp	8.0	9.5		A
VP <sub>MAX</sub>	Load Dump Voltage Withstand	Test conditions, t <sub>r</sub> > 2.5ms, t <sub>pulse</sub> < 50mS	60			V

**TPS4100 Pinout**

32-pin SSIP Package  
(Top view)

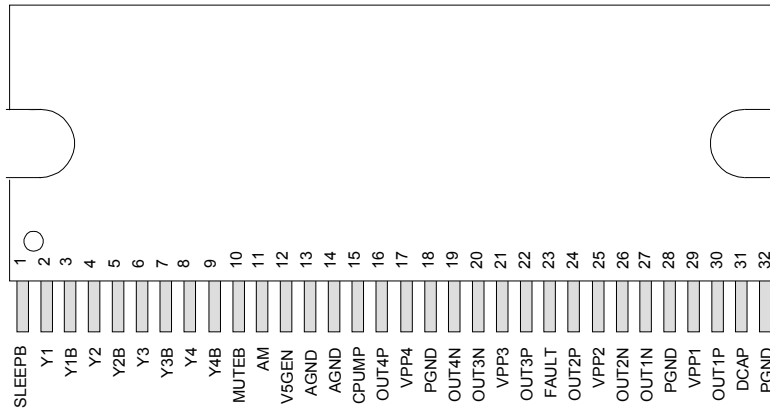

Note: The heat slug of the TPS4100 is connected to PGND.

## TPS4100 Pinout

PIN	NAME/FUNCTION	TYPE	DESCRIPTION
1	SLEEPB	INPUT (L)	Logic input, ACTIVE LOW. Setting SLEEP to low puts the TPS4100 in sleep mode. Input range is 0 to 5V with 3.3V compliant inputs.
2, 4, 6, 8	Y1, Y2, Y3, Y4	INPUT (L)	Non-inverted switching modulator inputs.
3, 5, 7, 9	Y1B, Y2B, Y3B, Y4B	INPUT (L)	Inverted switching modulator inputs.
10	MUTEB	INPUT (L)	Logic Input, ACTIVE LOW. Setting MUTE to low puts the device in mute mode. Typically driven by external power supply or microcontroller. Input range is 0 to 5V with 3.3V compliant inputs.
11	AM	INPUT (L)	Logic input, ACTIVE HIGH. Enables Analog Mode operation. Typically driven by Tripath controller. Input range is 0 to 5V with 3.3V compliant inputs.
12	5VGEN	OUTPUT	On chip 5V regulator bypass capacitor connection
12	HMUTEB	OUTPUT (L)	Logic output, ACTIVE LOW. HMUTEB low indicates TPS4100 is in mute mode
13, 14	AGND	GND	Analog ground
15	CPUMP	OUTPUT	Charge pump output capacitor
16	OUT4P	OUTPUT	Positive Output Channel 4
17	VPP4	POWER	Positive Supply Voltage Channel 4
18	PGND	GND	Power Ground for Outputs 3 and 4
19	OUT4N	OUTPUT	Negative Output Channel 4
20	OUT3N	OUTPUT	Negative Output Channel 3
21	VPP3	POWER	Positive Supply Voltage Channel 3
22	OUT3P	OUTPUT	Positive Output Channel 3
23	FAULT	OUTPUT (L)	Open Drain Logic Output, ACTIVE HIGH. FAULT high indicates fault condition.
24	OUT2P	OUTPUT	Positive Output Channel 2
25	VPP2	POWER	Positive Supply Voltage Channel 2
26	OUT2N	OUTPUT	Negative Output Channel 2
27	OUT1N	OUTPUT	Negative Output Channel 1
28	PGND	GND	Power Ground for Outputs 1 and 2
29	VPP1	POWER	Positive Supply Voltage Channel 1
30	OUT1P	OUTPUT	Positive Output Channel 1
31	DCAP	OUTPUT	Oscillator output for driving external charge pump circuit
32	PGND	GND	Power Ground

TPS4100 Connection Diagram

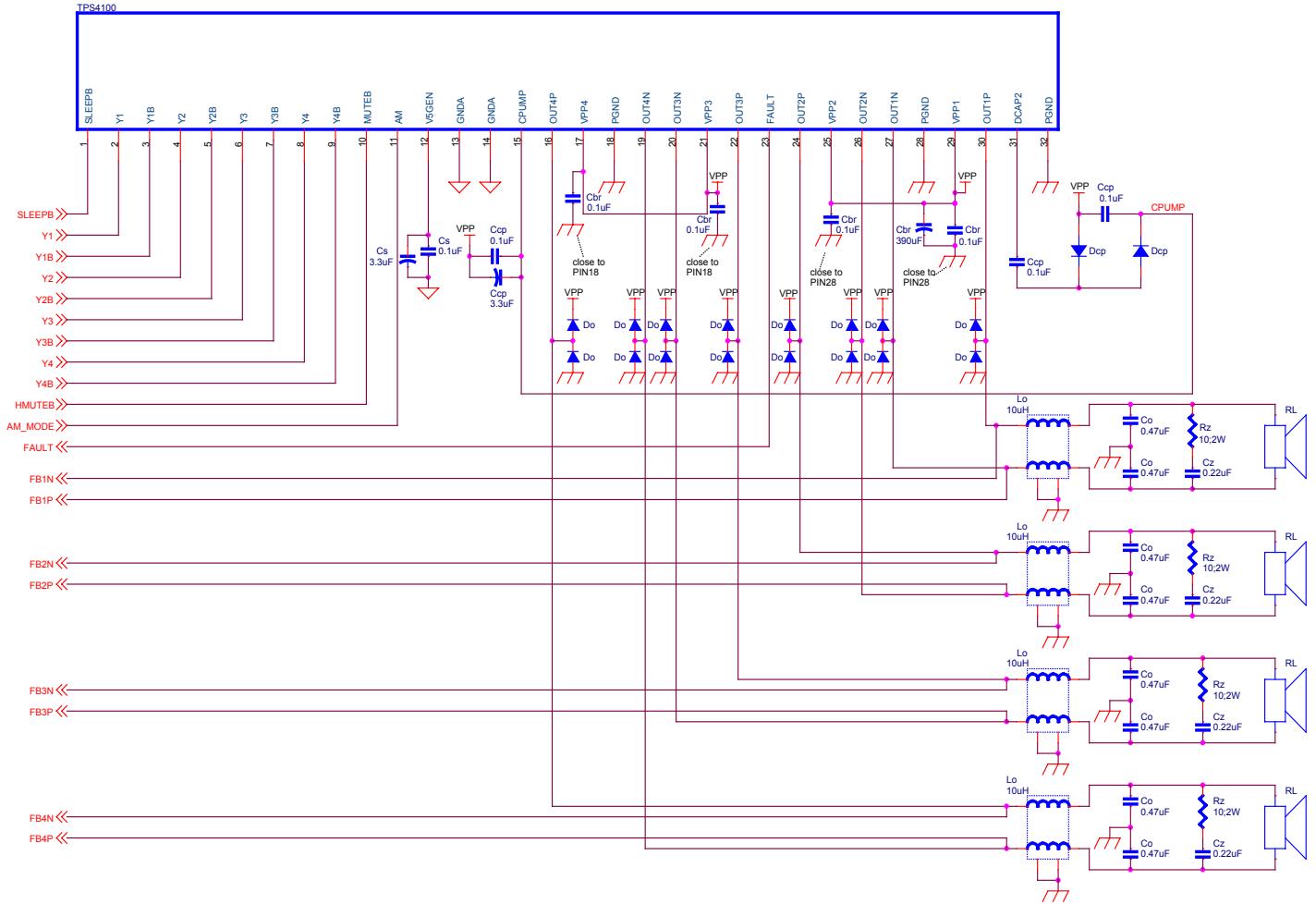

**External Components Description** (Refer to the Connection Diagram)

Components	Description
C <sub>S</sub>	Supply decoupling for the power supply pins. For optimum performance, these components should be located close to the TAA4100 and returned to their respective “ground” as shown in the Application/Test Circuit.
C <sub>BR</sub>	Supply decoupling for the high current full-bridge supply pins. These components must be located as close to the power supply pins as possible to minimize output ringing which causes power supply overshoot. By reducing overshoot, these capacitors maximize the TAA4100 reliability. These capacitors should have good high frequency performance including low ESR and low ESL.
C <sub>CP</sub>	Supply decoupling for the charge pump (high side gate drive supply) circuitry. These components must be located as close to the TAA4100 as possible.
D <sub>O</sub>	Output diode, which is used to minimize output overshoots/undershoots on the output nodes. These devices clamp the output to the low impedance node formed by the close connection of C <sub>BR</sub> . Note the connection shown in the Application/Test Circuit. The “high side” diode protects the bottom side device from excessive BV <sub>DSS</sub> due to overshoots on the output node. The “bottom side” diode protects the top side device from excessive BV <sub>DSS</sub> due to undershoots on the output node. This device must be an ultra fast rectifier capable of sustaining the entire supply range and high peak currents.
C <sub>Z</sub>	Zobel capacitor, which in conjunction with R <sub>Z</sub> , terminates the output filter at high frequencies. Use a high quality film capacitor capable of sustaining the ripple current caused by the switching outputs.
R <sub>Z</sub>	Zobel resistor, which in conjunction with C <sub>Z</sub> , terminates the output filter at high frequencies. The combination of R <sub>Z</sub> and C <sub>Z</sub> minimizes peaking of the output filter under both no load conditions or with real world loads, including loudspeakers, which usually exhibit a rising impedance with increasing frequency. Depending on the program material, the power rating of R <sub>Z</sub> may need to be adjusted. If the system requires full power operation at 20kHz then the power rating for R <sub>Z</sub> will likely need to be increased.
L <sub>O</sub>	Output inductor, which in conjunction with C <sub>O</sub> and C <sub>DO</sub> , demodulates (filters) the switching waveform into an audio signal. Forms a second order filter with a cutoff frequency of $f_c = 1 / (2\pi \sqrt{L_o C_{TOT}})$ and a quality factor of $Q = R_L C_{TOT} / 2\sqrt{L_o C_{TOT}}$ where $C_{TOT} = C_o    2 * C_{DO}$ .
C <sub>O</sub>	Output capacitor, which, in conjunction with L <sub>O</sub> , demodulates (filters) the switching waveform into an audio signal. Use a high quality film capacitor capable of sustaining the ripple current caused by the switching outputs.
C <sub>DO</sub>	Differential Output Capacitor. Differential noise decoupling for reduction of conducted emissions. Must be located near chassis exit point for maximum effectiveness.
R <sub>FAULT</sub>	Pull-up resistor for the open drain FAULT pin output. Recommended resistor value is 51kΩ.
D <sub>CP</sub>	Charge pump diodes. Used to generate floating supply for driving high side circuitry. Small signal diodes such as 1N4148 are recommended for these components.

## Typical Performance

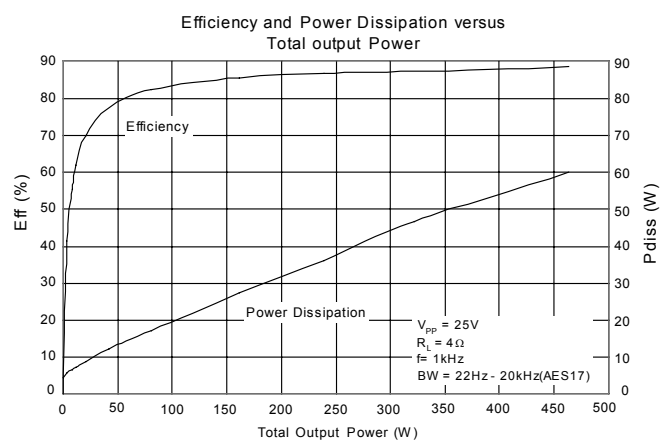
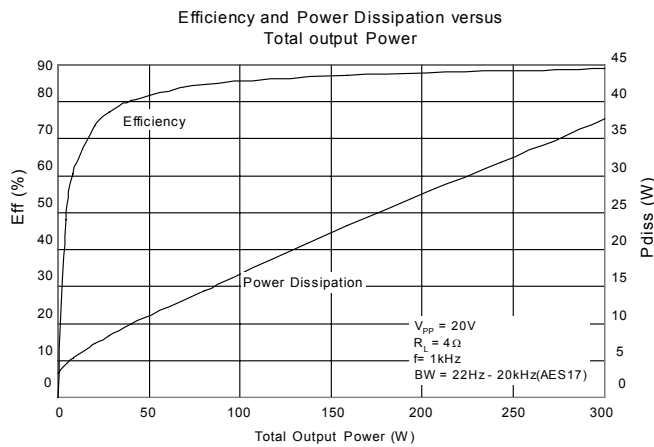
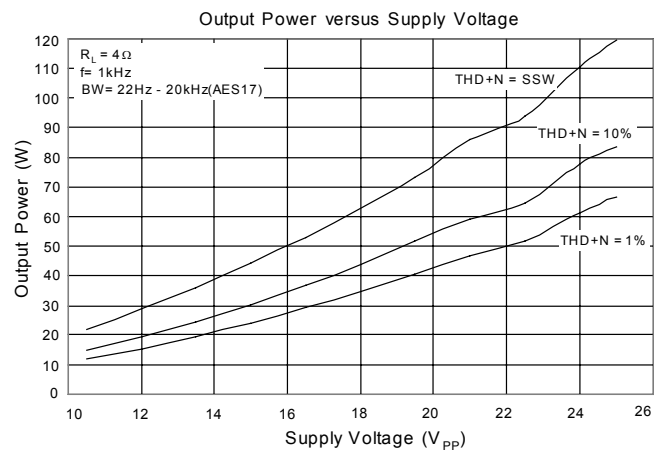
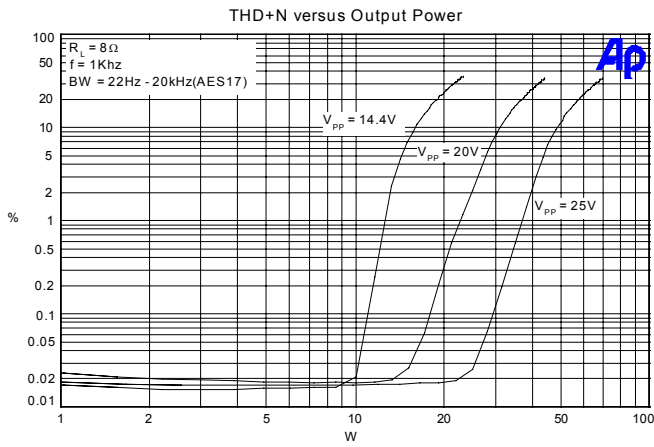
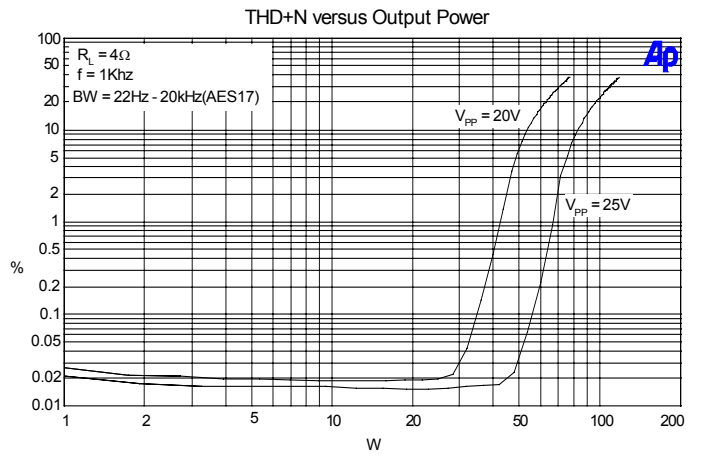
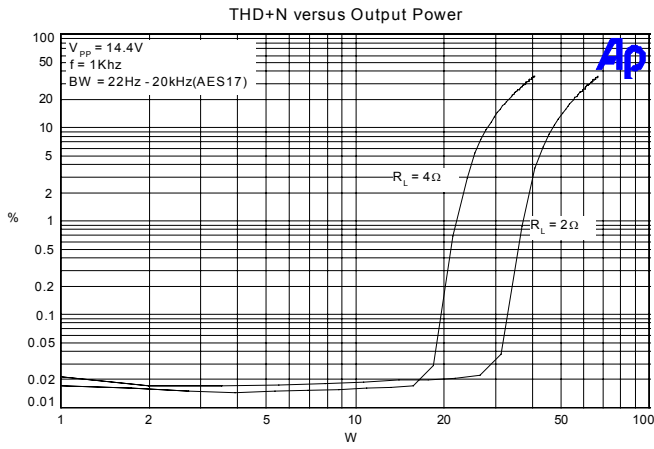



## Typical Performance AM Mode

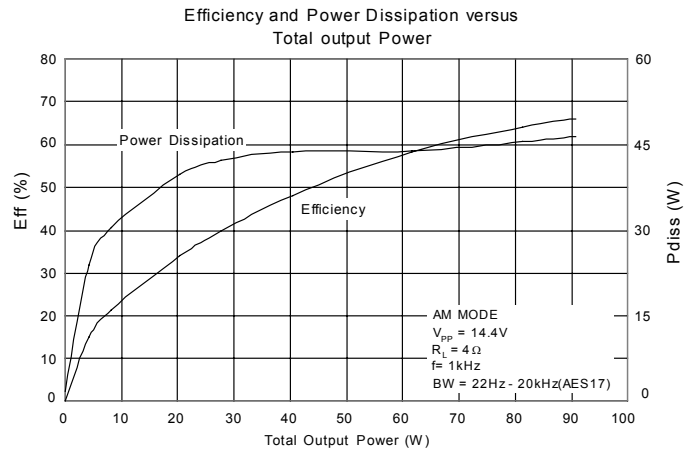
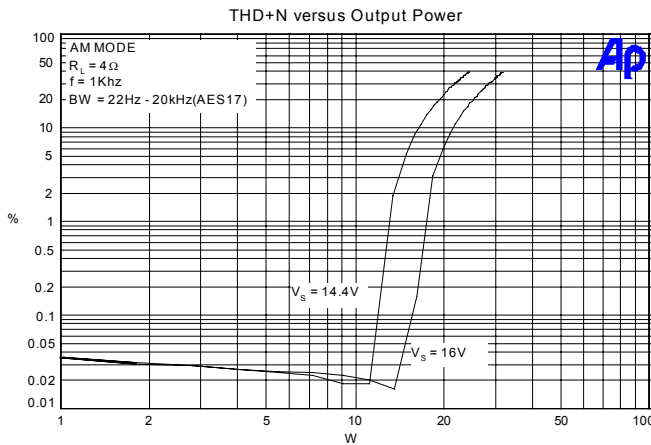

## Application Information

### GENERAL DESCRIPTION

The TPS4100 is a 4-channel BTL (Bridge Tied Load) audio amplifier power stage that operates on a single supply voltage ranging from 10-26V. The device is targeted specifically to meet the demands of OEM and aftermarket automobile in-dash head units. With a single supply voltage of 25V, the device delivers four 100 Watt (saturated square wave) channels into 4 ohm. Since the TPS4100 is a switching amplifier, the average dissipation at low to medium output power is far superior to best in class AB amplifiers specifically designed for in-dash head units.

### POWER SUPPLY REQUIREMENTS

The device is configured to operate from a single supply voltage of 10-26V. This allows the device to operate from an automobile battery under various conditions including: battery voltage with the engine off, alternator voltage with engine running and boosted voltage operation up to 26V using a DC-DC converter or voltage booster. The sleep pin must be driven from a microcontroller or external 3.3V or 5.0V power supply.

### AM MODE

When used in conjunction with a Class-T controller, such as TCD6001, the TPS4100 is configured as a high power, high efficiency, four channel switching amplifier. The TPS4100 also has an additional amplifier mode named “AM Mode.” By pulling the AM pin to a logic high level, the amplifier is configured as a Class B amplifier as opposed to the normal, Class-T amplifier.

AM mode significantly reduces EMI generation since the output amplifiers are now operated in linear mode. Operating in Class B mode also reduces the TPS4100 efficiency especially at low to medium output powers. Due to this increased power dissipation, it is recommended that the AM mode is used for applications such as AM radio playback where the average output level is minimal and a switching amplifier would most effect radio reception.

## **PROTECTION CIRCUITS**

The TPS4100 is guarded against over-current, over/under voltage, and over-temperature conditions. If the device goes into one of the various protection states, the FAULT pin goes to a logic HIGH state indicating a fault condition. When this occurs, all amplifier outputs are TRI-STATED and will float to VDD.

### **OVER-CURRENT PROTECTION**

An over-current fault occurs if more than approximately 9.5 amps (typical) of current flows from any of the amplifier output pins. This can occur if the speaker wires are shorted together, if one side of the speaker is shorted to ground, or if an output is connected to VPP.

### **OVER AND UNDER VOLTAGE PROTECTION**

An over-voltage fault occurs if the supply voltage is increased above 28.0 volts (typical), 26.0 volts (minimum). This fault puts the amplifier into mute and resets automatically once the supply voltage is reduced below the hysteresis band. The TPS4100 also has built-in load dump protection. This circuit puts the amplifier into sleep mode if the supply voltage is increased above 30V. The TPS4100 is able to survive power supply spikes to 60V if the duration is less than 50mS.

The TPS4100 is also equipped with under voltage protection. This circuit is activated if the supply voltage goes below 8.1 volts (typical) and causes the output to mute. Increasing the supply voltage above the hysteresis band (typically 9.5V) will bring the amplifier out of mute mode.

### **OVER-TEMPERATURE PROTECTION**

An over-temperature FAULT occurs if the junction temperature of the part exceeds 160°C (typical). The thermal hysteresis is approximately 30°C, therefore the fault will automatically clear when the junction temperature drops below 130°C.

### **SLEEP PIN (ACTIVE LOW)**

The SLEEPB ( $\overline{\text{SLEEP}}$ ) pin is a logic input that when pulled low puts the TPS4100 into a low quiescent current mode. This pin must be pulled up to an external 3.3V or 5V supply to activate (disable sleep mode) the TPS4100. The sleep pin cannot be pulled up to VPP due to internal circuitry limitations. The amplifier takes approximately 500mS to come out of sleep. This period of time allows the input capacitor to charge fully assuming a value of 0.47 $\mu$ F. If the input capacitor size is increased, then additional time will be required to allow for the input capacitor to fully charge. To ensure that turn on is pop-free, the input capacitor must be fully charged before MUTE $\overline{\text{B}}$  is pulled high.

### **MUTE $\overline{\text{B}}$ PIN**

The MUTE $\overline{\text{B}}$  pin is a logic input that mutes the TPS4100. Pulling this pin low activates the mute circuitry. Pulling the pin high enables output switching and amplification. Please note that the input stage is still biased at approximately 2.5V, even when MUTE $\overline{\text{B}}$  pin is low. This keeps the BIASCAP, C $\subscript{B}$  and input coupling capacitors, C $\subscript{i}$ , completely charged. This allows for a clean transition from mute to on, and vice-versa, which eliminates turn-on/off pops. Please note that DC calibration is done every time MUTE $\overline{\text{B}}$  transitions from low to high. The DC calibration takes approximately 6mS.

**FAULT PIN**

The FAULT pin is a logic output that indicates various fault conditions within the device. These conditions include: over-voltage, under-voltage, over-current at any output, low charge pump voltage, low 5V regulator voltage, and over-temperature (junction temperature greater than approximately 160°C).

The FAULT pin is an open drain output. The recommended pull-up to an external 3.3V or 5V supply is 51kΩ. Alternatively, this pin can be pulled up to VPP through a 51kΩ resistor. A logic high on this pin indicates a fault condition. This pin has a 1mA maximum sink current capability.

**CIRCUIT BOARD LAYOUT**

When used in conjunction with a Class T controller the TPS4100 is a power (high current) amplifier that operates at relatively high switching frequencies. Therefore, amplifier outputs switch between the supply voltage and ground at high speeds while driving high currents. This high-frequency digital signal is passed through an LC low-pass filter to recover the amplified audio signal. Since the amplifier must drive the inductive LC output filter and speaker loads, the amplifier outputs can be pulled above the supply voltage and below ground by the energy in the output inductance. To avoid subjecting the TPS4100 to potentially damaging voltage stress, it is critical to have a good printed circuit board layout. It is recommended that Tripath's layout and application circuit be used for all applications and only be deviated from after careful analysis of the effects of any changes. Please refer to the TPS4100 evaluation board document, EB-TPS4100, available on the Tripath website, at [www.tripath.com](http://www.tripath.com).

The following components are important to place near either their associated TPS4100 pins. The recommendations are ranked in order of layout importance, either for proper device operation or performance considerations.

- The capacitors,  $C_{BR}$ , provide high frequency bypassing of the amplifier power supplies and will serve to reduce spikes and modulation of the power supply rails. Please note that bypassing requires a combination of capacitors for adequate stabilization.
- The output diodes,  $D_O$ , are used to minimize overshoots/undershoots on the output node. Improper routing of these diodes will render them useless due to PCB trace inductance. Thus, these components must be located very close to the output pins with the "other side of the diode" routed directly to the appropriate VPP or PGND pin.

The capacitors,  $C_S$ , provide high frequency bypassing of the amplifier power supplies. Please note that bypassing requires a combination of capacitors for adequate stabilization.

**OUTPUT FILTER DESIGN**

One advantage of Tripath amplifiers over PWM solutions is the ability to use higher-cutoff-frequency filters. This means any load-dependent peaking/droop in the 20kHz audio band potentially caused by the filter can be made negligible. This is especially important for applications where the user may select a 4Ω or 8Ω speaker. Furthermore, speakers are not purely resistive loads and the impedance they present changes over frequency and from speaker model to speaker model.

The core material of the output filter inductor has an effect on the distortion levels produced by a TPS4100 amplifier. Tripath recommends low-mu type-2 iron powder cores because of their low loss and high linearity or high current capability bobbin types that will not saturate at peak currents below 9A.

Recently, there have been a number of dual inductors designed specifically for bridged output switching amplifiers. These dual inductors are two inductors shielded by a common ferrite shield. They may be

manufactured as common mode chokes with the windings wound in the same direction or as differential mode chokes with the windings wound in opposite directions. Since the ferrite reduces the energy storage capability of the inductor, it is important to ensure that the shielded dual inductor does not saturate at the maximum currents attainable by the TPS4100. Dual inductors wound as common mode inductors may aid in reducing common mode noise to the load. They also may result in lower than initial inductances due to electric field cancellation effects.

Tripath also recommends that an RC damper be used after the LC low-pass filter. No-load operation of a TPS4100 amplifier can create significant peaking in the LC filter, which produces strong resonant currents that can overheat the integrated MOSFETs and/or other components. The RC dampens the peaking and prevents problems.

It is highly recommended that the design process for a TPS4100 amplifier include an analysis of the interaction of intended speaker(s) with the LC filter and RC damper to ensure the desired frequency response is attained. Component values for the LC filter and RC damper may need to be altered from the Tripath suggestions to achieve the required response.

## Package Information

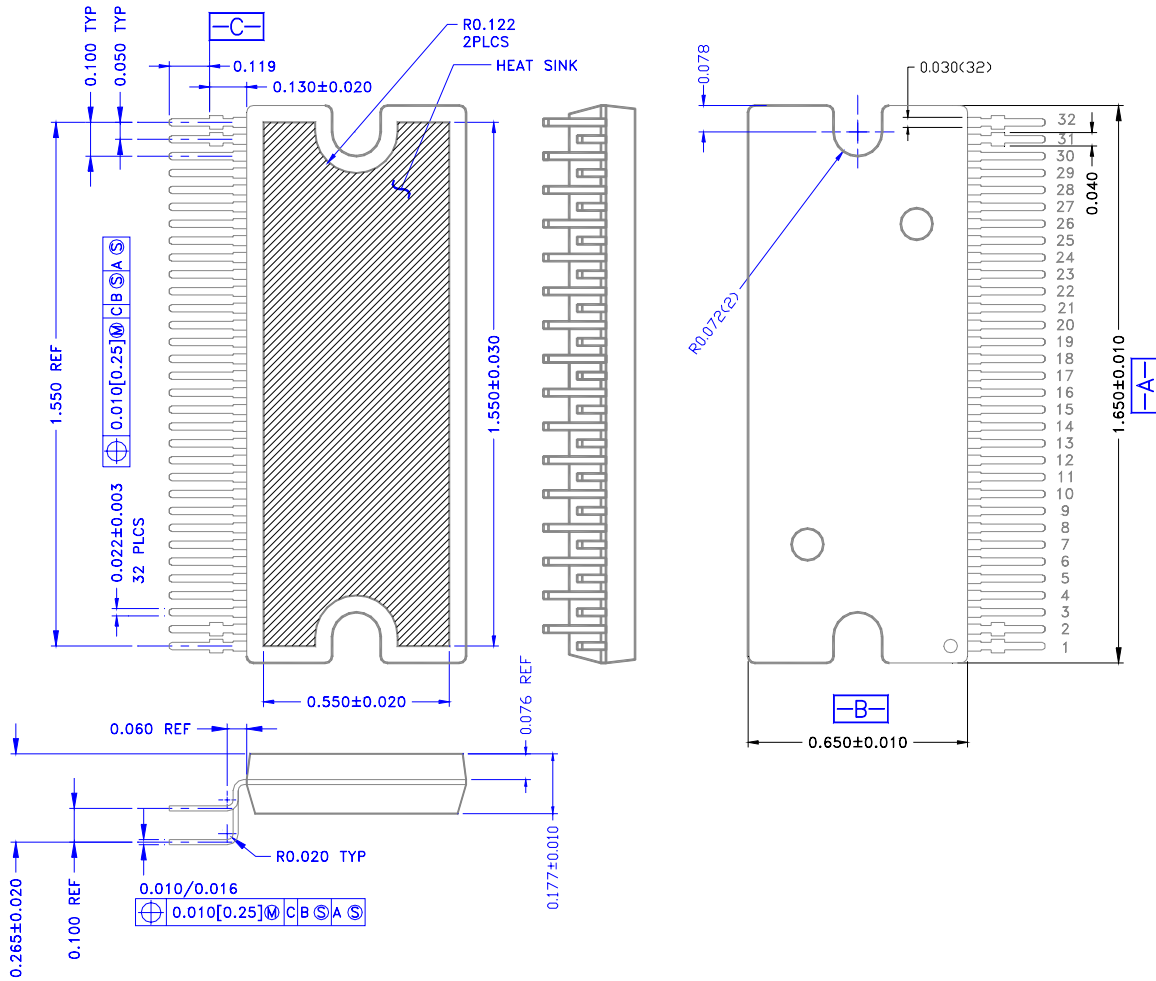

Tripath Technology Inc. reserves the right to make changes without further notice to any products herein to improve reliability, function or design. Tripath does not assume any liability arising out of the application or use of any product or circuit described herein; neither does it convey any license under its patent rights, nor the rights of others.

TRIPATH'S PRODUCTS ARE NOT AUTHORIZED FOR USE AS CRITICAL COMPONENTS IN LIFE SUPPORT DEVICES OR SYSTEMS WITHOUT THE EXPRESS WRITTEN CONSENT OF THE PRESIDENT OF TRIPATH TECHNOLOGY INC.

As used herein:

1. Life support devices or systems are devices or systems which, (a) are intended for surgical implant into the body, or (b) support or sustain life, and whose failure to perform, when properly used in accordance with instructions for use provided in this labeling, can be reasonably expected to result in significant injury to the user.
2. A critical component is any component of a life support device or system whose failure to perform can be reasonably expected to cause the failure of the life support device or system, or to affect its safety or effectiveness.

## Contact Information

### **TRIPATH TECHNOLOGY, INC**

2560 Orchard Parkway, San Jose, CA 95131

408.750.3000 - P

408.750.3001 - F

For more Sales Information, please visit us @ [www.tripath.com/contact.htm](http://www.tripath.com/contact.htm)

For more Technical Information, please visit us @ [www.tripath.com/data.htm](http://www.tripath.com/data.htm)