

DATA SHEET

83C754/87C754

80C51 8-bit microcontroller family

4K/256 OTP/ROM, DAC, comparator, UART, reference

Preliminary specification
Supersedes data of 1997 Dec 03
IC20 Data Handbook

1998 Apr 23

80C51 8-bit microcontroller family

4K/256 OTP/ROM, DAC, comparator, UART, reference

83C754/87C754

DESCRIPTION

The Philips 83C754/87C754 offers many of the advantages of the 80C51 architecture in a small package and at low cost.

The 8XC754 Microcontroller is fabricated with Philips high-density CMOS technology. Philips epitaxial substrate minimizes CMOS latch-up sensitivity.

The 8XC754 contains a 4k × 8 ROM (83C754) EPROM (87C754), a single module PCA, a 256 × 8 RAM, 11 I/O lines, two 16-bit counter/timers, a two-priority level interrupt structure, a full duplex serial channel, an on-chip oscillator, and an 8-bit D/A converter.

The EPROM version of this device, the 87C754, is available in plastic one-time programmable (OTP) packages. Once the array has been programmed, it is functionally equivalent to the masked ROM 83C754. Thus, unless explicitly stated otherwise, all references made to the 87C754 apply equally to the 83C754.

The 8XC754 supports two power reduction modes of operation referred to as the idle mode and the power-down mode.

FEATURES

- Available in erasable quartz lid or One-Time Programmable plastic packages
- 80C51-based architecture
- Small package sizes – 28-pin SSOP
- Wide oscillator frequency range
- Power control modes:
 - Idle mode
 - Power-down mode
- 4k × 8 ROM (83C754)
EPROM (87C754)
- 256 × 8 RAM
- Two 16-bit auto reloadable counter/timers
- Single module PCA counter/timer
- Full duplex serial channel
- Boolean processor
- CMOS and TTL compatible

PIN CONFIGURATION

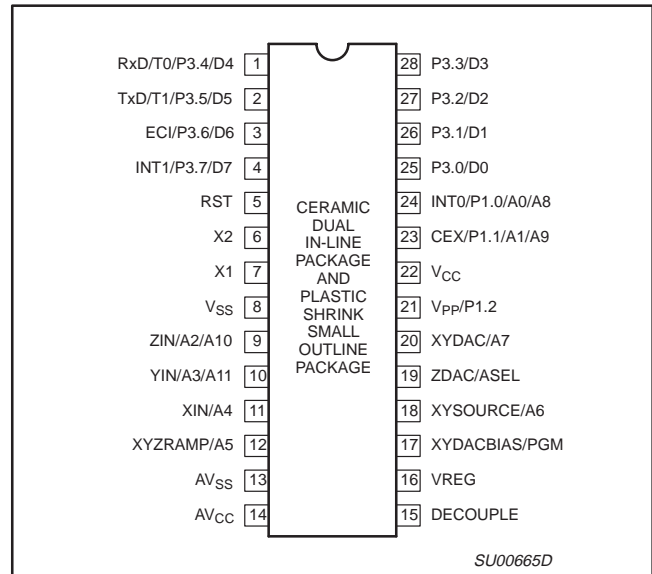

PART NUMBER SELECTION

ROM	EPROM ¹	TEMPERATURE RANGE °C AND PACKAGE	FREQUENCY	DRAWING NUMBER	
P83C754EBD DB	P87C754EBD DB	OTP	0 to +70, 28-pin Shrink Small Outline Package	3.5 to 16MHz	SOT341-1

NOTE:

1. OTP = One Time Programmable EPROM. UV = UV Erasable EPROM.

80C51 8-bit microcontroller family

4K/256 OTP/ROM, DAC, comparator, UART, reference

83C754/87C754

BLOCK DIAGRAM

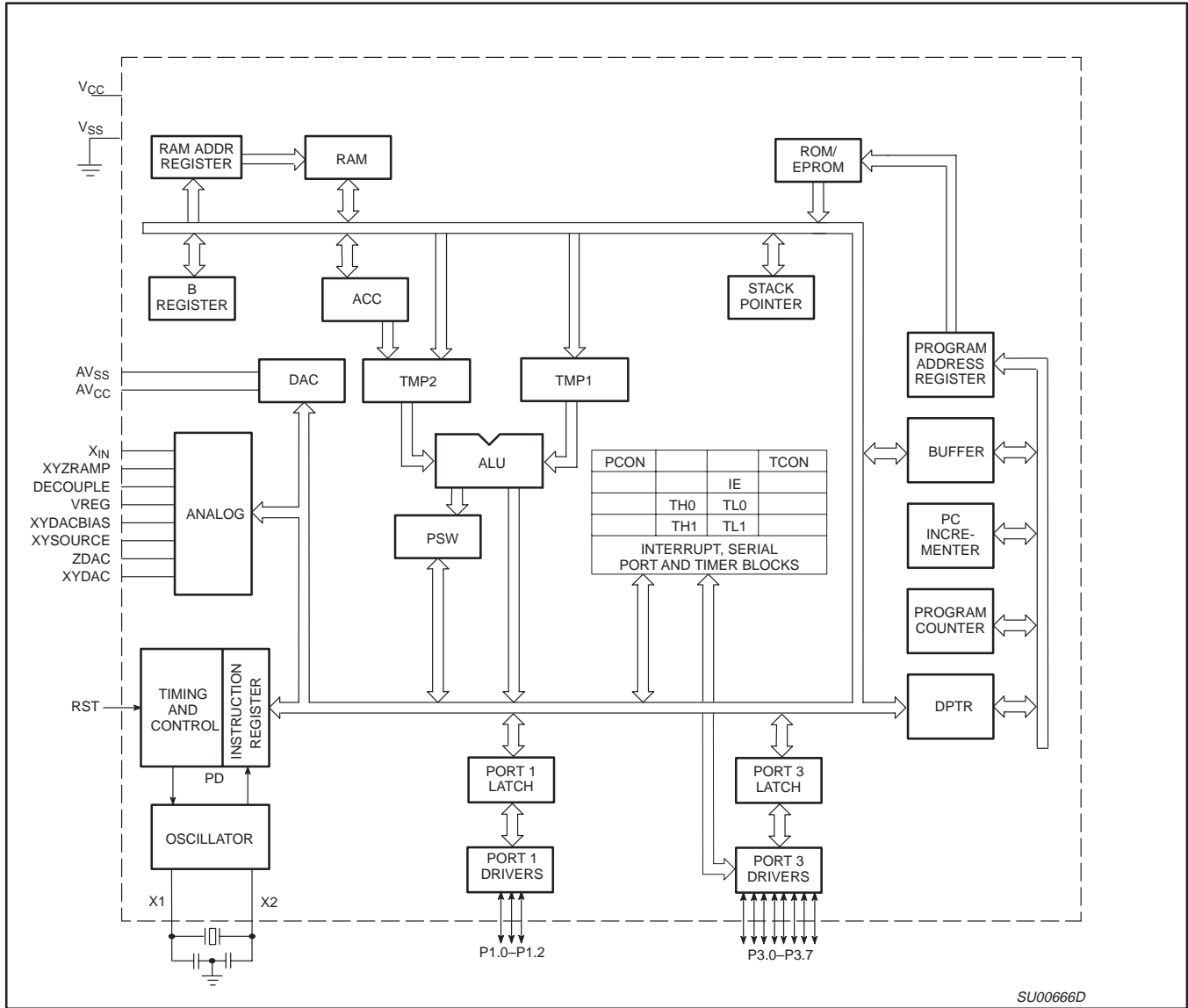

80C51 8-bit microcontroller family

4K/256 OTP/ROM, DAC, comparator, UART, reference

83C754/87C754

PIN DESCRIPTION

MNEMONIC	DIP PIN NO.	TYPE	NAME AND FUNCTION
V _{SS}	8	I	Circuit Ground Potential.
V _{CC}	22	I	Supply voltage during normal, idle, and power-down operation.
P1.0–P1.2	21, 23, 24	I/O	Port 1: Port 1 is a 3-bit bidirectional I/O port with internal pull-ups on P1.0 and P1.1. Port 1 pins that have 1s written to them can be used as inputs. As inputs, port 1 pins that are externally pulled low will source current because of the internal pull-ups (P1.0, P1.1). (See DC Electrical Characteristics: I _{IL}). Port 1 also serves the special function features listed below (Note: P1.0 does not have the strong pullup that is on for 2 oscillator periods.):
	24	I	INT0 (P1.0): External interrupt 0.
	23	O	CEX (P1.1): PCA clock output.
	21	I	V_{PP} (P1.2): Programming voltage input (open drain).
P3.0–P3.7	1–4, 25–28	I/O	Port 3: Port 3 is an 8-bit bidirectional I/O port with internal pull-ups. Port 3 pins that have 1s written to them are pulled high by the internal pull-ups and can be used as inputs. As inputs, port 3 pins that are externally being pulled low will source current because of the pull-ups. (See DC Electrical Characteristics: I _{IL}). Port 3 also functions as the data input for the EPROM memory location to be programmed (or verified). (Note: P3.5 does not have the strong pullup that is on for 2 oscillator periods.)
			Port 3 also serves the special function as listed below:
	3	I	ECI (P3.6): External PCA clock input.
	1	I	RxD/T0 (P3.4): Serial port receiver data input. Timer 0 external clock input.
	4	I	INT1: External interrupt 1.
	2	I	TxD/T1 (P3.5): Serial port transmitter data. Timer 1 external clock input.
RST	5	I	Reset: A high on this pin for two machine cycles while the oscillator is running resets the device. After the device is reset, a 10-bit serial sequence, sent LSB first, applied to RESET, places the device in the programming state allowing programming address, data and V _{PP} to be applied for programming or verification purposes. The RESET serial sequence must be synchronized with the X1 input. (Note: The 83/87C754 does not have an internal reset resistor.)
X1	7	I	Crystal 1: Input to the inverting oscillator amplifier and input to the internal clock generator circuits. X1 also serves as the clock to strobe in a serial bit stream into RESET to place the device in the programming state.
X2	6	O	Crystal 2: Output from the inverting oscillator amplifier.
AV _{CC} ¹	14	I	Analog supply voltage and reference input.
AV _{SS} ¹	13	I	Analog supply and reference ground.
ZIN	9	I	ZIN: Input to analog multiplexer.
YIN	10	I	YIN: Input to analog multiplexer.
XIN	11	I	XIN: Input to analog multiplexer.
XYZRAMP	12	O	XYZRAMP: Provides a low impedance pulldown to V _{SS} under S/W control.
DECOUPLE	15	O	Decouple: Output from regulated supply for connection of decoupling capacitors.
VREG	16	O	VREG: Provides regulated analog supply output.
XYDACBIAS	17	O	XYDACBIAS: Provides source voltage for bias of external circuitry. – Input which specifies verify mode (output enable) or the program mode. /PGM = 1 output enabled (verify mode). /PGM = 0 program mode.
XYSOURCE	18	O	XYSOURCE: Provides source voltage from regulated analog supply.
ZDAC	19	O	ZDAC: Switchable outp from the internal DAC. ASEL (P0.0) – Input which indicates which bits of the EPROM address are applied to port 3. ASEL = 0 low address byte available on port 3. ASEL = 1 high address byte available on port 3 (only the three least significant bits are used).
XYDAC	20	O	XYDAC: Non-switchable output from the internal DAC.

NOTE:

1. AV_{SS} (reference ground) must be connected to 0V (ground). AV_{CC} (reference input) cannot differ from V_{CC} by more than ±0.2V, and must be in the range 4.5V to 5.5V.

80C51 8-bit microcontroller family

4K/256 OTP/ROM, DAC, comparator, UART, reference

83C754/87C754

OSCILLATOR CHARACTERISTICS

X1 and X2 are the input and output, respectively, of an inverting amplifier which can be configured for use as an on-chip oscillator.

To drive the device from an external clock source, X1 should be driven while X2 is left unconnected. There are no requirements on the duty cycle of the external clock signal, because the input to the internal clock circuitry is through a divide-by-two flip-flop. However, minimum and maximum high and low times specified in the data sheet must be observed.

IDLE MODE

The 8XC754 includes the 80C51 power-down and idle mode features. In idle mode, the CPU puts itself to sleep while all of the on-chip peripherals stay active. The instruction to invoke the idle mode is the last instruction executed in the normal operating mode before the idle mode is activated. The CPU contents, the on-chip RAM, and all of the special function registers remain intact during this mode. The idle mode can be terminated either by any enabled interrupt (at which time the process is picked up at the interrupt service routine and continued), or by a hardware reset which starts the processor in the same manner as a power-on reset. Upon powering-up the circuit, or exiting from idle mode, sufficient time must be allowed for stabilization of the internal analog reference voltages before a D/A conversion is started.

Special Function Registers

The special function registers (directly addressable only) contain all of the 8XC754 registers except the program counter and the four register banks. Most of the special function registers are used to control the on-chip peripheral hardware. Other registers include arithmetic registers (ACC, B, PSW), stack pointer (SP) and data pointer registers (DPH, DPL). Twelve of the SFRs are bit addressable.

Data Pointer

The data pointer (DPTR) consists of a high byte (DPH) and a low byte (DPL). In the 80C51 this register allows the access of external data memory using the MOVX instruction. Since the 83C754 does not support MOVX or external memory accesses, this register is generally used as a 16-bit offset pointer of the accumulator in a MOVC instruction. DPTR may also be manipulated as two independent 8-bit registers.

POWER-DOWN MODE

In the power-down mode, the oscillator is stopped and the instruction to invoke power-down is the last instruction executed. Only the contents of the on-chip RAM are preserved. A hardware reset is the only way to terminate the power-down mode. The control bits for the reduced power modes are in the special function register PCON.

Table 1. External Pin Status During Idle and Power-Down Modes

MODE	Port 1	Port 3
Idle	Data	Data
Power-down	Data	Data

STANDARD SERIAL INTERFACE

The serial port is full duplex, meaning it can transmit and receive simultaneously. It is also receive-buffered, meaning it can commence reception of a second byte before a previously received byte has been read from the register. (However, if the first byte still has not been read by the time reception of the second byte is complete, one of the bytes will be lost.) The serial port receive and transmit registers are both accessed at Special Function Register SBUF. Writing to SBUF loads the transmit register, and reading SBUF accesses a physically separate receive register.

The serial port can operate in 4 modes:

- Mode 0:** Serial data enters and exits through RxD. TxD outputs the shift clock. 8 bits are transmitted/received (LSB first). The baud rate is fixed at 1/12 the oscillator frequency.
- Mode 1:** 10 bits are transmitted (through TxD) or received (through RxD): a start bit (0), 8 data bits (LSB first), and a stop bit (1). On Receive, the stop bit goes into RB8 in Special Function Register SCON. The baud rate is variable.
- Mode 2:** 11 bits are transmitted (through TxD) or received (through RxD): a start bit (0), 8 data bits (LSB first), a programmable 9th data bit, and a stop bit (1). On Transmit, the 9th data bit (TB8 in SCON) can be assigned the value of 0 or 1. Or, for example, the parity bit (P, in the PSW) could be moved into TB8. On Receive, the 9th data bit goes into RB8 in Special Function Register SCON, while the stop bit is ignored. The baud rate is programmable to either 1/32 or 1/64 the oscillator frequency.
- Mode 3:** 11 bits are transmitted (through TxD) or received (through RxD): a start bit (0), 8 data bits (LSB first), a programmable 9th data bit, and a stop bit (1). In fact, Mode 3 is the same as Mode 2 in all respects except baud rate. the baud rate in Mode 3 is variable.

In all four modes, transmission is initiated by any instruction that uses SBUF as a destination register. Reception is initiated in Mode 0 by the condition RI = 0 and REN = 1. Reception is initiated in the other modes by the incoming start bit if REN = 1.

Multiprocessor Communications

Modes 2 and 3 have a special provision for multiprocessor communications. In these modes, 9 data bits are received. The 9th one goes into RB8. Then comes a stop bit. The port can be programmed such that when the stop bit is received, the serial port interrupt will be activated only if RB8 = 1. This feature is enabled by setting bit SM2 in SCON. A way to use this feature in multiprocessor systems is as follows:

When the master processor wants to transmit a block of data to one of several slaves, it first sends out an address byte which identifies the target slave. An address byte differs from a data byte in that the 9th bit is 1 in an address byte and 0 in a data byte. With SM2 = 1, no slave will be interrupted by a data byte. An address byte, however, will interrupt all slaves, so that each slave can examine the received byte and see if it is being addressed. The addressed slave will clear its SM2 bit and prepare to receive the data bytes that will be coming. The slaves that were not being addressed leave their SM2s set, and go on about their business, ignoring the coming data bytes.

SM2 has no effect in Mode 0, and in Mode 1 can be used to check the validity of the stop bit. In a Mode 1 reception, if SM2 = 1, the receive interrupt will not be activated unless a valid stop bit is received.

80C51 8-bit microcontroller family

4K/256 OTP/ROM, DAC, comparator, UART, reference

83C754/87C754

Serial Port Control Register

The serial port control and status register is the Special Function Register SCON, shown in Figure 1. This register contains not only the mode selection bits, but also the 9th data bit for transmit and receive (TB8 and RB8), and the serial port interrupt bits (TI and RI).

Baud Rates

The baud rate in Mode 0 is fixed: Mode 0 Baud Rate = Oscillator Frequency / 12. The baud rate in Mode 2 depends on the value of bit SMOD in Special function Register PCON. If SMOD = 0 (which is the value on reset), the baud rate is 1/64 the oscillator frequency. If SMOD = 1, the baud rate is 1/32 the oscillator frequency.

$$\text{Mode 2 Baud Rate} = \frac{2^{\text{SMOD}}}{64} \times (\text{Oscillator Frequency})$$

In the 8XC754, the baud rates in Modes 1 and 3 are determined by the Timer 1 overflow rate.

Using Timer 1 to Generate Baud Rates

When Timer 1 is used as the baud rate generator, the baud rates in Modes 1 and 3 are determined by the Timer 1 overflow rate and the value of SMOD as follows:

$$\text{Mode 1, 3 Baud Rate} = \frac{2^{\text{SMOD}}}{32} \times (\text{Timer 1 Overflow Rate})$$

The Timer 1 interrupt should be disabled in this application. The Timer itself can be configured for either "timer" or "counter" operation, and in any of its 3 running modes. In the most typical applications, it is configured for "timer" operation, in the auto-reload mode (high nibble of TMOD = 0010B). In that case the baud rate is given by the formula:

$$\text{Mode 1, 3 Baud Rate} = \frac{2^{\text{SMOD}}}{32} \times \frac{\text{Oscillator Frequency}}{12 \times [256 - (\text{TH1})]}$$

One can achieve very low baud rates with Timer 1 by leaving the Timer 1 interrupt enabled, and configuring the Timer to run as a 16-bit timer (high nibble of TMOD = 0001B), and using the Timer 1 interrupt to do a 16-bit software reload. Figure 2 lists various commonly used baud rates and how they can be obtained from Timer 1.

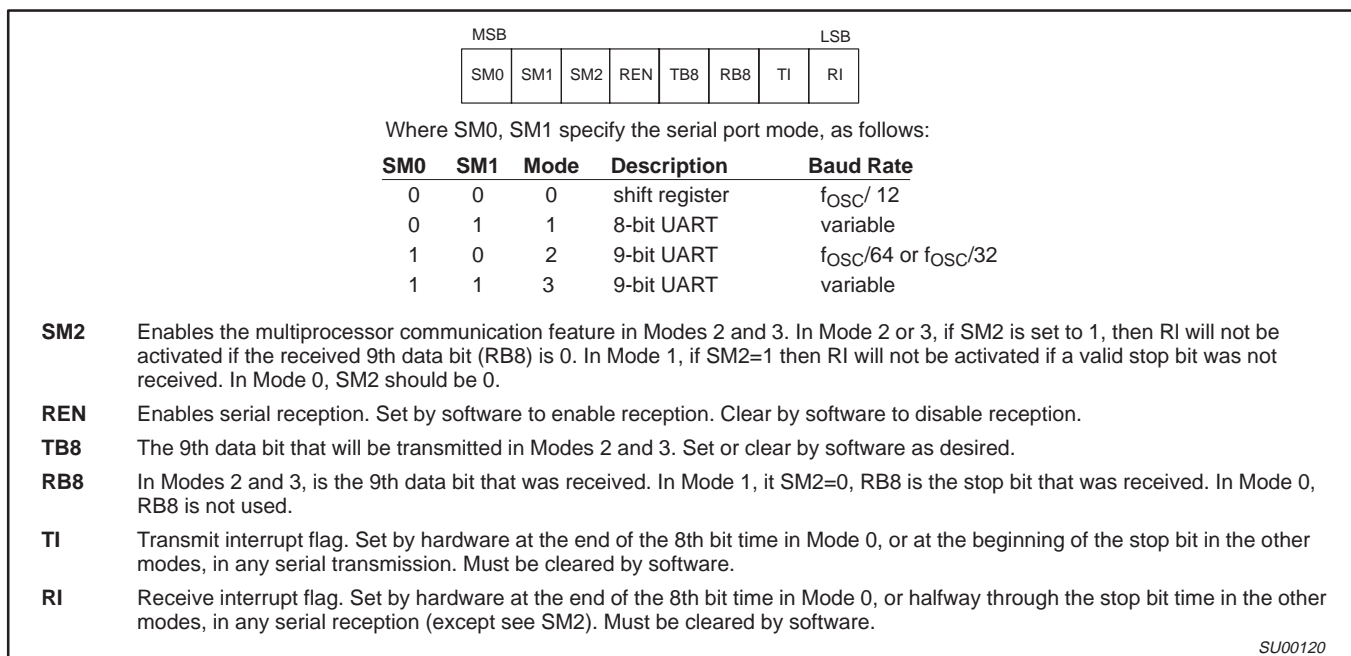

Figure 1.

Baud Rate	fosc	SMOD	Timer 1		
			C/T	Mode	Reload Value
Mode 0 Max: 1.67MHz	20MHz	X	X	X	X
Mode 2 Max: 625k	20MHz	1	X	X	X
Mode 1, 3 Max: 104.2k	20MHz	1	0	2	FFH
19.2k	11.059MHz	1	0	2	FDH
9.6k	11.059MHz	0	0	2	FDH
4.8k	11.059MHz	0	0	2	FAH
2.4k	11.059MHz	0	0	2	F4H
1.2k	11.059MHz	0	0	2	E8H
137.5	11.986MHz	0	0	2	1DH
110	6MHz	0	0	2	72H
110	12MHz	0	0	1	FEEBH

Figure 2. Timer 1 Generated Commonly Used Baud Rates

80C51 8-bit microcontroller family

4K/256 OTP/ROM, DAC, comparator, UART, reference

83C754/87C754

DIFFERENCES BETWEEN THE 8XC754 AND THE 80C51

Program Memory

On the 8XC754, program memory is 4096 bytes long and is not externally expandable, so the 80C51 instructions MOVX, LJMP, and LCALL are not implemented. If these instructions are executed, the appropriate number of instruction cycles will take place along with external fetches; however, no operation will take place. The LJMP may not respond to all program address bits. The only fixed locations in program memory are the addresses at which execution is taken up in response to reset and interrupts, which are as follows:

Event	Program Memory Address
Reset	000
External $\overline{\text{INT0}}$	003
Timer 0	00B
External $\overline{\text{INT1}}$	013
PCA	01B
SIO/TF1	023

Memory Organization

The 8XC754 manipulates operands in three memory address spaces. The first is the program memory space which contains program instructions as well as constants such as look-up tables. The program memory space contains 4k bytes in the 8XC754.

The second memory space is the data memory array which has a logical address space of 256 bytes.

The third memory space is the special function register array having a 128-byte address space (80H to FFH). Only selected locations in this memory space are used (see Table 2). Note that the architecture of these memory spaces (internal program memory, internal data memory, and special function registers) is identical to the 80C51, and the 8XC754 varies only in the amount of memory physically implemented.

The 8XC754 does not directly address any external data or program memory spaces. For this reason, the MOVX instructions in the 80C51 instruction set are not implemented in the 83C754, nor are the alternate I/O pin functions RD and WR.

I/O Ports

The I/O pins provided by the 8XC754 consist of port 1 and port 3.

Port 1

Port 1 is a 3-bit bidirectional I/O port and includes alternate functions on some pins of this port. P1.1 is provided with internal pullups while the remaining pins (P1.0 and P1.2) are an open drain output structure. The alternate functions for port 1 are:

- INT0 – External interrupt 0.
- PCAOUT – PCA clock output
- V_{PP} – External programming voltage.

Port 3

Port 3 is an 8-bit bidirectional I/O port structure. P3.5 is open drain.

The alternate functions for port 3 are:

- RxD – Serial port receiver data input.
- T1 – Timer 1 external clock input.
- $\overline{\text{INT1}}$ – External interrupt 1.
- TxD – Serial port transmitter data.
- T0 – Timer 0 external clock input.
- ECl – PCA external clock input.

Analog Section

The analog section of the 8XC754, shown in Figure 3, consists of four major elements: a bandgap referenced voltage regulator, an 8-bit DAC, an input multiplexer and comparator, and a low impedance pulldown device.

The bandgap voltage regulator uses the AV_{CC} pin as its supply and produces a regulated output on the VREG pin. The bandgap reference is enabled/disabled by AC0. The regulator also supplies the analog supply voltage for the DAC. The regulator may be switched on/off by means of the AC1 bit in the analog control register (ACON0). The regulator output may also be supplied to the XYDACBIAS and XYSOURCE pins by means of bits AC3 and AC4, respectively. The DECOUPLE pin is provided for decoupling the regulator output.

The DAC is an 8-bit device and its output appears on the XYDAC pin. In addition, the DAC output may also be routed to the ZDAC pin by means of bit AC6 in the ACON0 register. The DAC output is not buffered, so external load impedances should be taken into consideration when using either of these outputs.

A 3-input multiplexer is provided, whose output is connected to the positive reference of a comparator. The multiplexer output is controlled by bits MUX2:0 of ACON1. A bandgap reference supplies the negative reference of the comparator. The output of the comparator may be used to trigger the capture input of PCA module.

A low impedance pulldown is supplied at the XYZRAMP pin and is controlled by bit AC5 of ACON0.

Interrupt Subsystem—Fixed Priority

The interrupt structure is a seven-source, two-level interrupt system. Simultaneous interrupt conditions are resolved by a single-level, fixed priority as follows:

- Highest priority: Pin $\overline{\text{INT0}}$
Timer flag 0
Pin $\overline{\text{INT1}}$
PCA
- Lowest priority: Serial I/O – TF1

The vector addresses are as follows:

Source	Vector Address
INT0	0003H
TF0	000BH
INT1	0013H
PCA	001BH
SIO/TF1	0023H

Interrupt Enable Register

MSB							LSB
EA	–	–	ES/T1	EC	EX1	ET0	EX0

Position	Symbol	Function
IE.7	EA	Global interrupt disable when EA = 0
IE.6	–	
IE.5	–	
IE.4	ES/T1	Serial port/Timer Flag 1
IE.3	EC	PCA interrupt
IE.2	EX1	External interrupt 1
IE.1	ET0	Timer 0 overflow
IE.0	EX0	External interrupt 0

80C51 8-bit microcontroller family
 4K/256 OTP/ROM, DAC, comparator, UART, reference

83C754/87C754

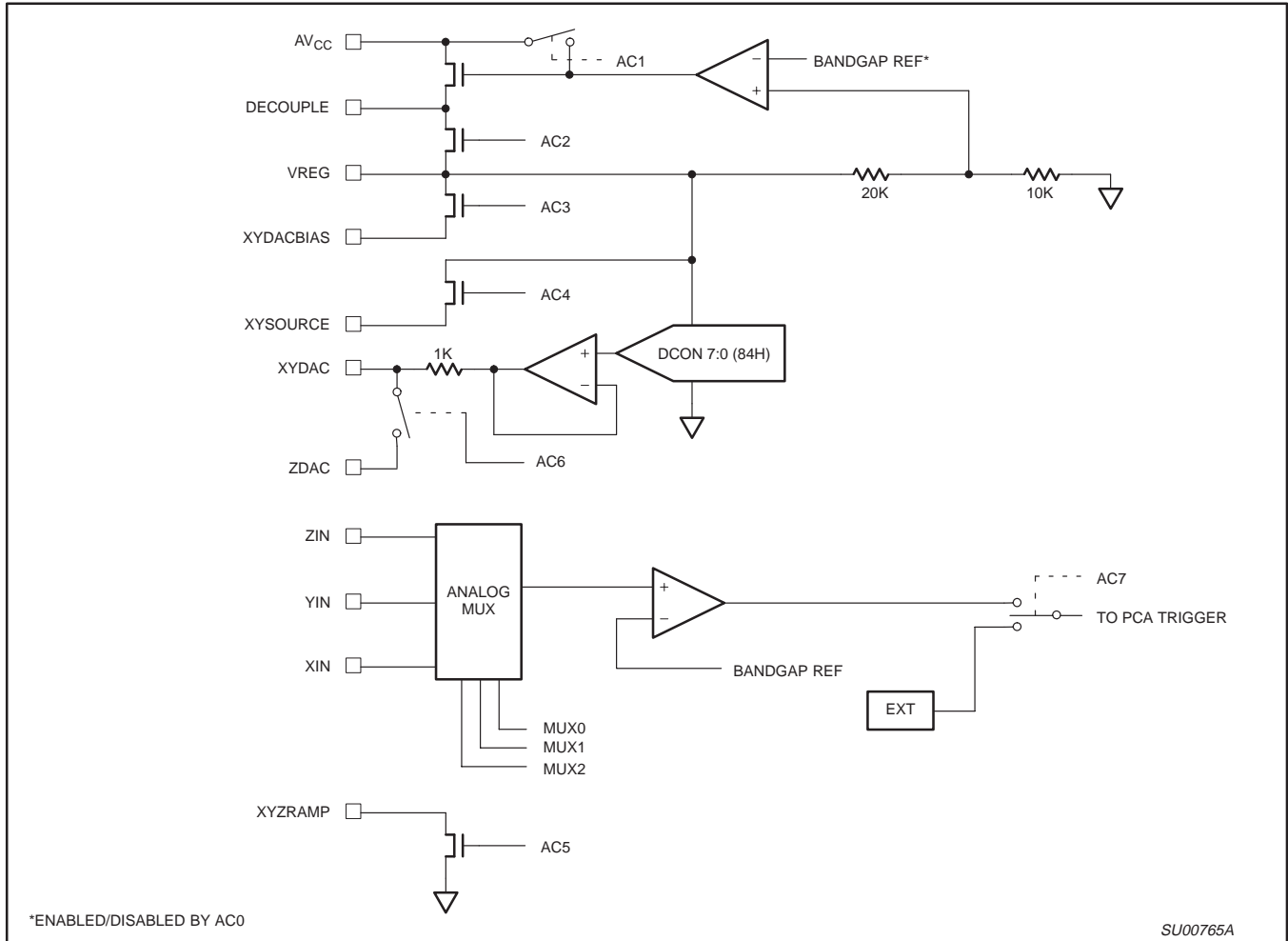

Figure 3. Analog Section

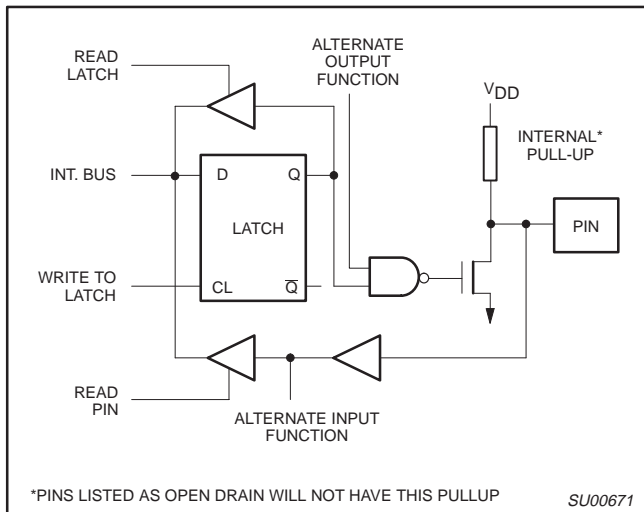

Figure 4. Typical Port Bit Latches and I/O Buffers

80C51 8-bit microcontroller family
4K/256 OTP/ROM, DAC, comparator, UART, reference

83C754/87C754

Table 2. 8XC754 Special Function Registers

SYMBOL	DESCRIPTION	DIRECT ADDRESS	BIT ADDRESS, SYMBOL, OR ALTERNATIVE PORT FUNCTION								RESET VALUE
			MSB				LSB				
ACC*	Accumulator	E0H	E7	E6	E5	E4	E3	E2	E1	E0	00H
ACON0*	Analog Control 0	A0H	AC7	AC6	AC5	AC4	AC3	AC2	AC1	AC0	
ACON1*	Analog Control 1	C0H	-	-	-	-	TSI	MUX2	MUX1	MUX0	
B*	B register	F0H	F7	F6	F5	F4	F3	F2	F1	F0	00H
CCAPH#	PCA Module Capture High	FEH									
CCAPL#	PCA Module Capture Low	EEH									
CCAPM#	PCA Module Mode	DEH	-	ECOM	CAPP	CAPN	MAT	TOG	PWM	ECCF	x0000000B
			DF	DE	DD	DC	DB	DA	D9	D8	
CCON*#	PCA Counter Control	D8H	CF	CR	-	CCF4	-	-	-	-	00x00000B
CH#	PCA Counter High	F9H									00H
CL#	PCA Counter Low	E9H									00H
CMOD#	PCA Counter Mode	D9H	CODL	WDTE	-	-	-	CPS1	CPS0	ECF	00xxx000B
DCON	DAC Control	84H									
DPTR:	Data pointer (2 bytes)										
DPL	Data pointer low	82H									00H
DPH	Data pointer high	83H									00H
IE*#	Interrupt Enable	A8H	AF	AE	AD	AC	AB	AA	A9	A8	
			EA	-	-	ES/T1	EC	EX1	ET0	EX0	00H
IP*	Interrupt Priority	B8H	AF	AE	AD	AC	AB	AA	A9	A8	
			-	-	-	PS/T1	PPC	PX1	PT0	PX0	x0000000B
P1*#	Port 1	90H	-	-	-	-	-	ZIN	XYZRAMP	XYSOURCE	xxx11111B
			-	-	-	84	83	82	81	80	
P3*#	Port 3	B0H	INT1	ECI	TxD	RxD	-	-	-	-	
PCON	Power control	87H	SMOD1	SMOD0	-	POF	GF1	GF0	PD	IDL	00xxxx00B
			D7	D6	D5	D4	D3	D2	D1	D0	
PSW*	Program status word	D0H	CY	AC	F0	RS1	RS0	OV	-	P	00H
SBUF	Serial Data Buffer	99H									xxxxxxxxxB
SP	Stack pointer	81H									07H
SCON*	Serial Control	98H	9F	9E	9D	9C	9B	9A	99	98	
			SM0	SM1	SM2	REN	TB8	RB8	TI	RI	00H
TCON*	Timer Control	88H	8F	8E	8D	8C	8B	8A	89	88	
			TF1	TR1	TF0	TR0	IE1	IT1	IE0	IT0	00H
TH0	Timer High 0	8CH									00H
TH1	Timer High 1	8DH									00H
TL0	Timer Low 0	8AH									00H
TL1	Timer Low 1	8BH									00H
TMOD	Timer Mode	89H	GATE	C/T	M1	M0	GATE	C/T	M1	M0	00H
			C7	C6	C5	C4	C3	C2	C1	C0	

* SFRs are bit addressable.

SFRs are modified from or added to the 80C51 SFRs.

80C51 8-bit microcontroller family

4K/256 OTP/ROM, DAC, comparator, UART, reference

83C754/87C754

COUNTER/TIMER

The 8XC754 counter/timers are designated Timer 0 and 1. They are identical to the 80C51 counter/timers. (Timer 1 shares its interrupt with the serial port.)

Programmable Counter Array (PCA)

The Programmable Counter Array is a special Timer that has one 16-bit capture/compare module associated with it. The module can be programmed to operate in one of four modes: rising and/or falling edge capture, software timer, high-speed output, or pulse width modulator. The basic PCA configuration is shown in Figure 5.

The PCA timer can be programmed to run at: 1/12 the oscillator frequency, 1/4 the oscillator frequency, the Timer 0 overflow, or the input on the ECI pin (P3.1). The timer count source is determined from the CPS1 and CPS0 bits in the CMOD SFR as follows (see Figure 8):

CPS1	CPS0	PCA Timer Count Source
0	0	1/12 oscillator frequency
0	1	1/4 oscillator frequency
1	0	Timer 0 overflow
1	1	External Input at ECI pin

In the CMOD SFR are three additional bits associated with the PCA. They are CIDL which allows the PCA to stop during idle mode, WDTE which enables or disables the watchdog function, and ECF which when set causes an interrupt and the PCA overflow flag, CF (in the CCON SFR) to be set when the PCA timer overflows. These functions are shown in Figure 6.

The watchdog timer function is implemented in module 4 as implemented in other parts that have a PCA that are available on the market.

The CCON SFR contains the run control bit for the PCA and the flags for the PCA timer (CF) and module (refer to Figure 9). To run the PCA the CR bit (CCON.6) must be set by software. The PCA is shut off by clearing this bit. The CF bit (CCON.7) is set when the PCA counter overflows and an interrupt will be generated if the ECF bit in the CMOD register is set. The CF bit can only be cleared by software. Bit 4 of the CCON register is the flag for the module and is set by hardware when either a match or a capture occurs. This flag can only be cleared by software. The PCA interrupt system shown in Figure 7.

The CCAPM register contains the bits that control the mode in which the module will operate. The ECCF bit enables the CCF flag in the CCON SFR to generate an interrupt when a match or compare occurs in the associated module. PWM (CCAPM.1) enables the pulse width modulation mode. The TOG bit (CCAPM.2) when set causes the CEX output associated with the module to toggle when there is a match between the PCA counter and the module's capture/compare register. The match bit MAT (CCAPM.3), when set, will cause the CCF bit in the CCON register to be set when there is

a match between the PCA counter and the module's capture/compare register.

The next two bits CAPN (CCAPM.4) and CAPP (CCAPM.5) determine the edge that a capture input will be active on. The CAPN bit enables the negative edge, and the CAPP bit enables the positive edge. If both bits are set both edges will be enabled and a capture will occur for either transition. The last bit in the register ECOM (CCAPM.6) when set enables the comparator function. Figure 11 shows the CCAPM settings for the various PCA functions.

There are two additional registers associated with the PCA module. They are CCAPH and CCAPL and these are the registers that store the 16-bit count when a capture occurs or a compare should occur. When the module is used in the PWM mode these registers are used to control the duty cycle of the output.

PCA Capture Mode

To use the PCA module in the capture mode, either one or both of the CCAPM bits CAPN and CAPP must be set. The external CEX input for the module is sampled for transition. When a valid transition occurs, the PCA hardware loads the value of the PCA counter registers (CH and CL) into the module's capture registers (CCAPL and CCAPH). If the CCF bit for the module in the CCON SFR and the ECCF bit in the CCAPM SFR are set, then an interrupt will be generated. Refer to Figure 12.

16-bit Software Timer Mode

The PCA modules can be used as software timers by setting both the ECOM and MAT bits in the module's CCAPM register. The PCA timer will be compared to the module's capture registers and when a match occurs an interrupt will occur if the CCF (CCON SFR) and the ECCF (CCAPM SFR) bits for the module are both set (see Figure 13).

High Speed Output Mode

In this mode the CEX output associated with the PCA module will toggle each time a match occurs between the PCA counter and the module's capture registers. To activate this mode the TOG, MAT, and ECOM bits in the module's CCAPM SFR must be set (see Figure 14).

Pulse Width Modulator Mode

The PCA module can be used as a PWM output. Figure 15 shows the PWM function. The frequency of the output depends on the source for the PCA timer. The duty cycle of the module is independently variable using the module's capture register CCAPL. When the value of the PCA CL SFR is less than the value in the module's CCAPL SFR, the output will be low, when it is equal to or greater than the output will be high. When CL overflows from FF to 00, CCAPL is reloaded with the value in CCAPH. This allows updating the PWM without glitches. The PWM and ECOM bits in the module's CCAPM register must be set to enable the PWM mode.

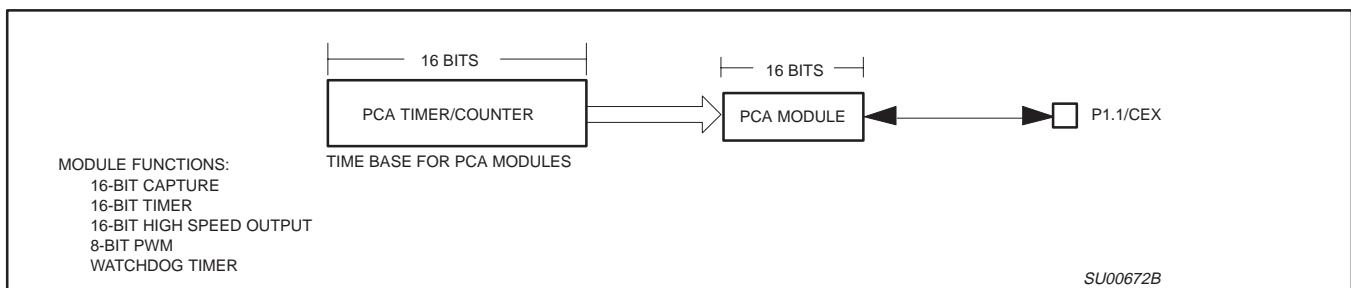

Figure 5. Programmable Counter Array (PCA)

80C51 8-bit microcontroller family
 4K/256 OTP/ROM, DAC, comparator, UART, reference

83C754/87C754

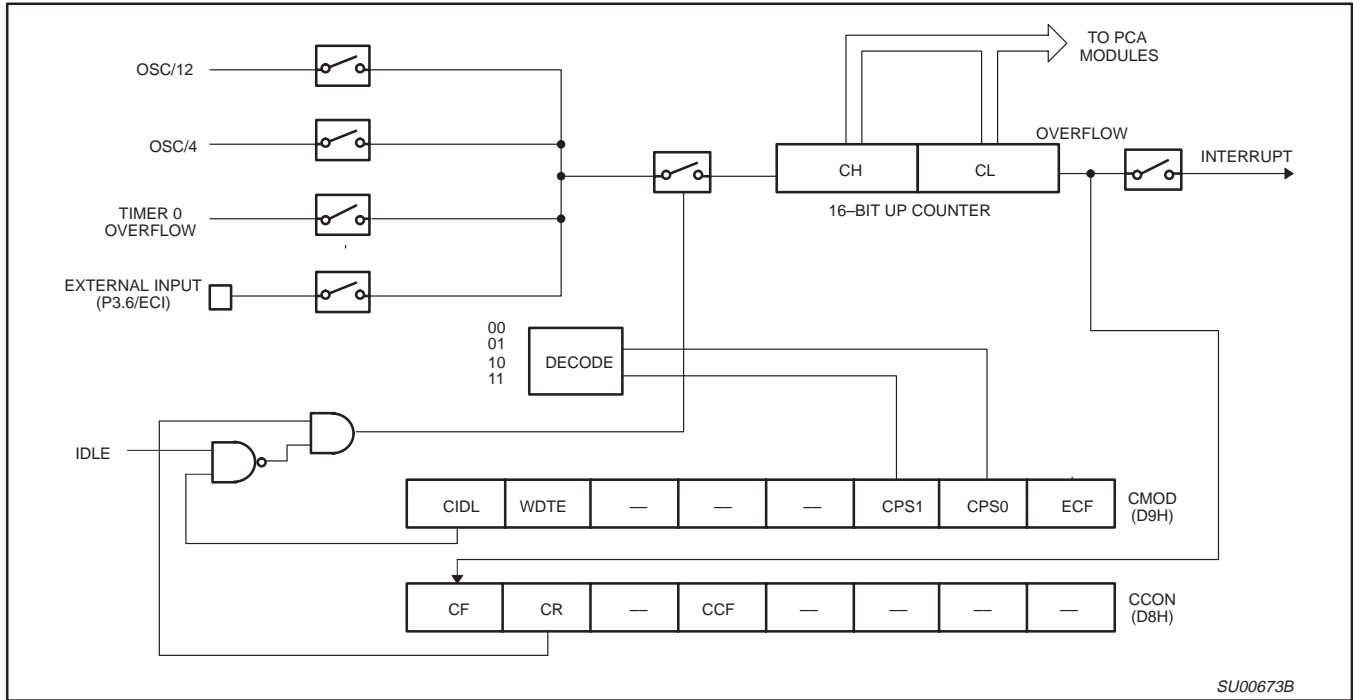

Figure 6. PCA Timer/Counter

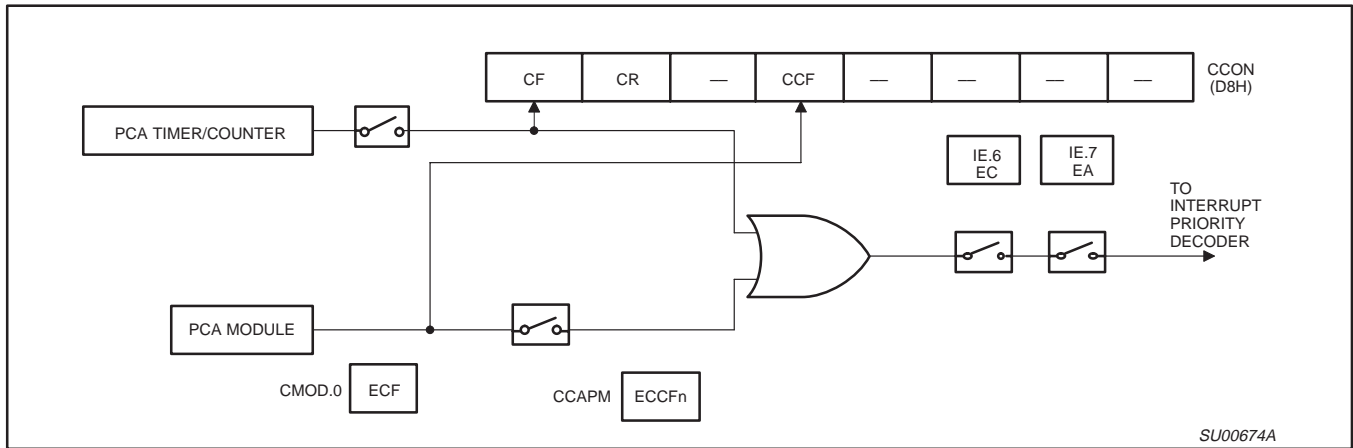

Figure 7. PCA Interrupt System

80C51 8-bit microcontroller family
4K/256 OTP/ROM, DAC, comparator, UART, reference

83C754/87C754

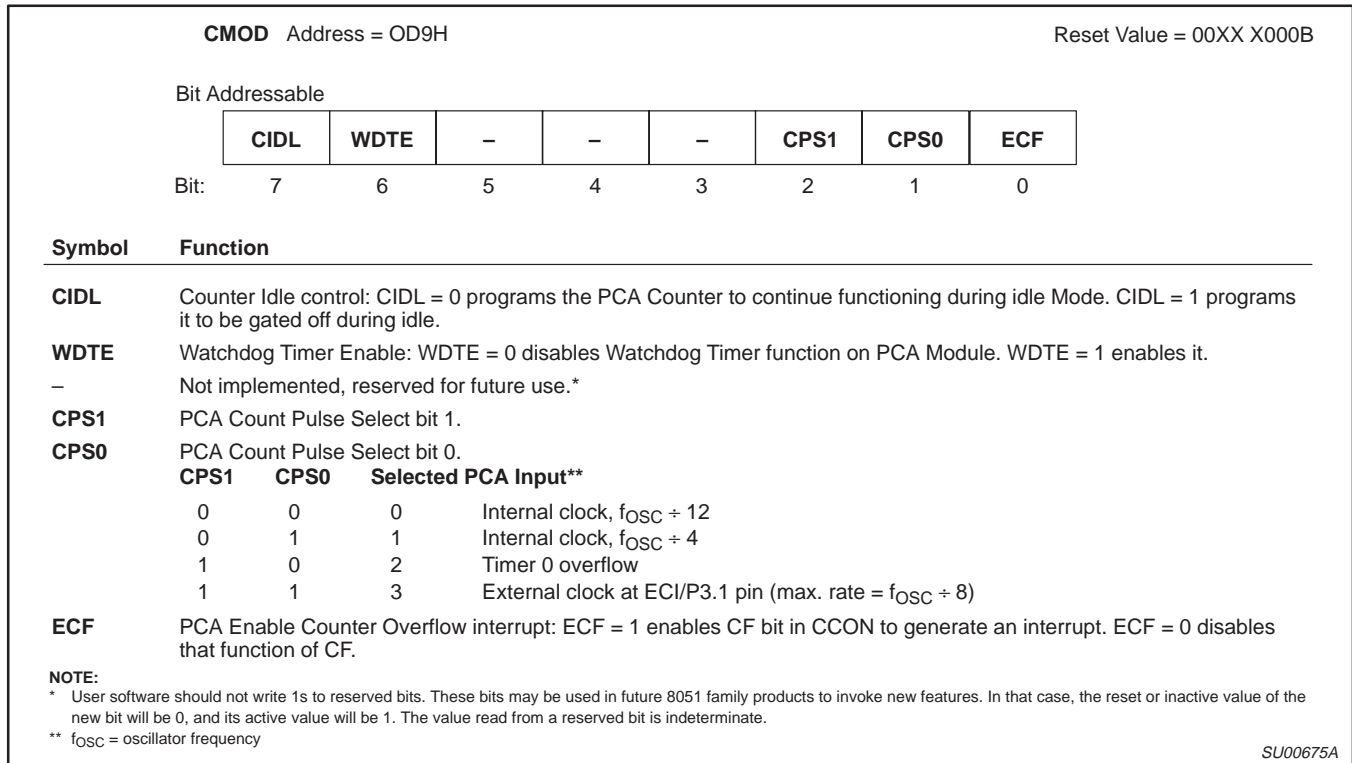

Figure 8. CMOD: PCA Counter Mode Register

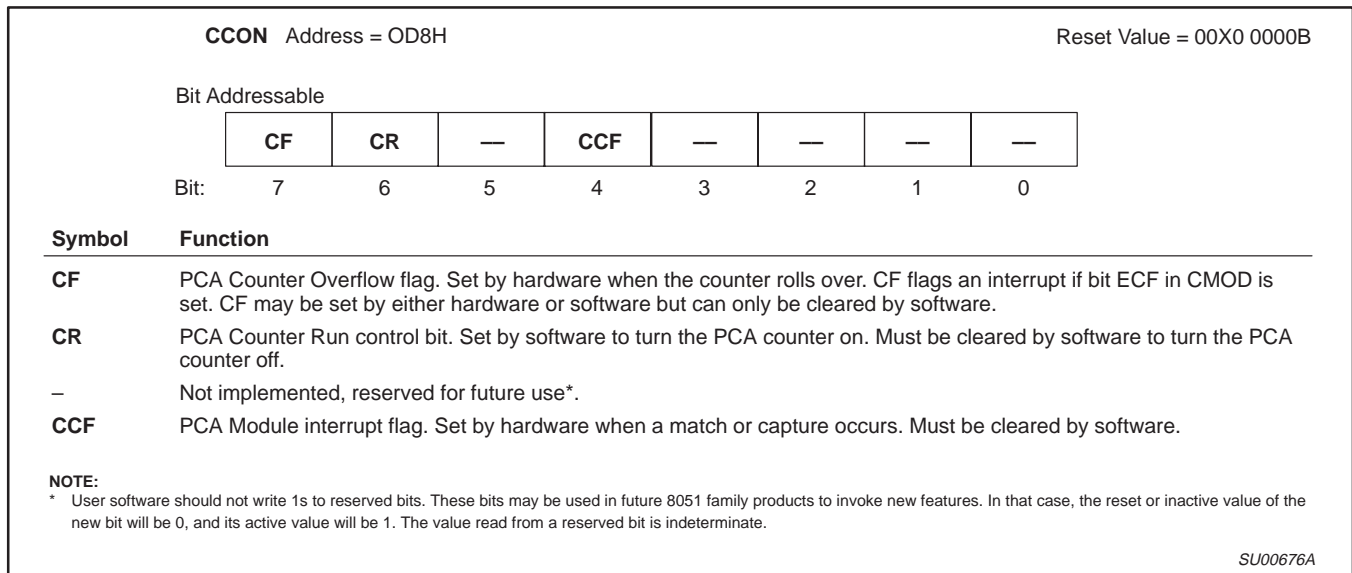

Figure 9. CCON: PCA Counter Control Register

80C51 8-bit microcontroller family
4K/256 OTP/ROM, DAC, comparator, UART, reference

83C754/87C754

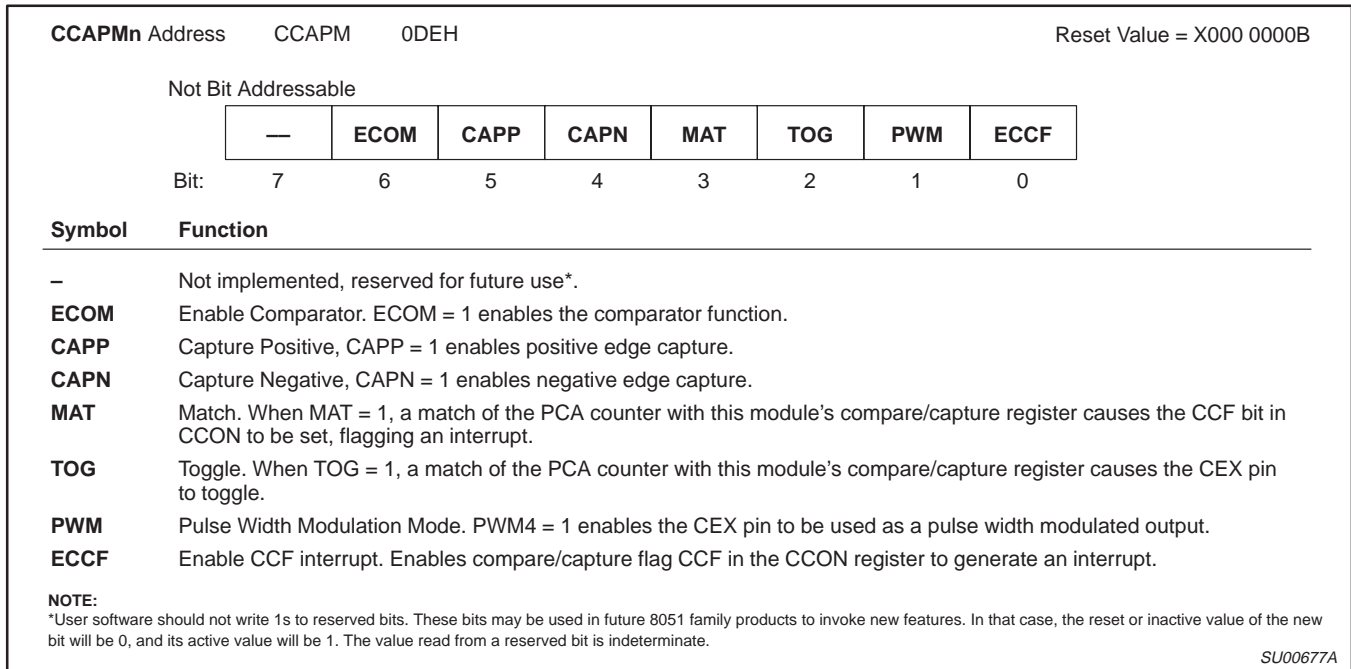

Figure 10. CCAPM: PCA Modules Compare/Capture Registers

—	ECOM	CAPP	CAPN	MAT	TOG	PWM	ECCF	MODULE FUNCTION
X	0	0	0	0	0	0	0	No operation
X	X	1	0	0	0	0	X	16-bit capture by a positive-edge trigger on CEX
X	X	0	1	0	0	0	X	16-bit capture by a negative trigger on CEX
X	X	1	1	0	0	0	X	16-bit capture by a transition on CEX
X	1	0	0	1	0	0	X	16-bit Software Timer
X	1	0	0	1	1	0	X	16-bit High Speed Output
X	1	0	0	0	0	1	0	8-bit PWM
X	1	0	0	1	X	0	X	Watchdog Timer

Figure 11. PCA Module Modes (CCAPM Register)

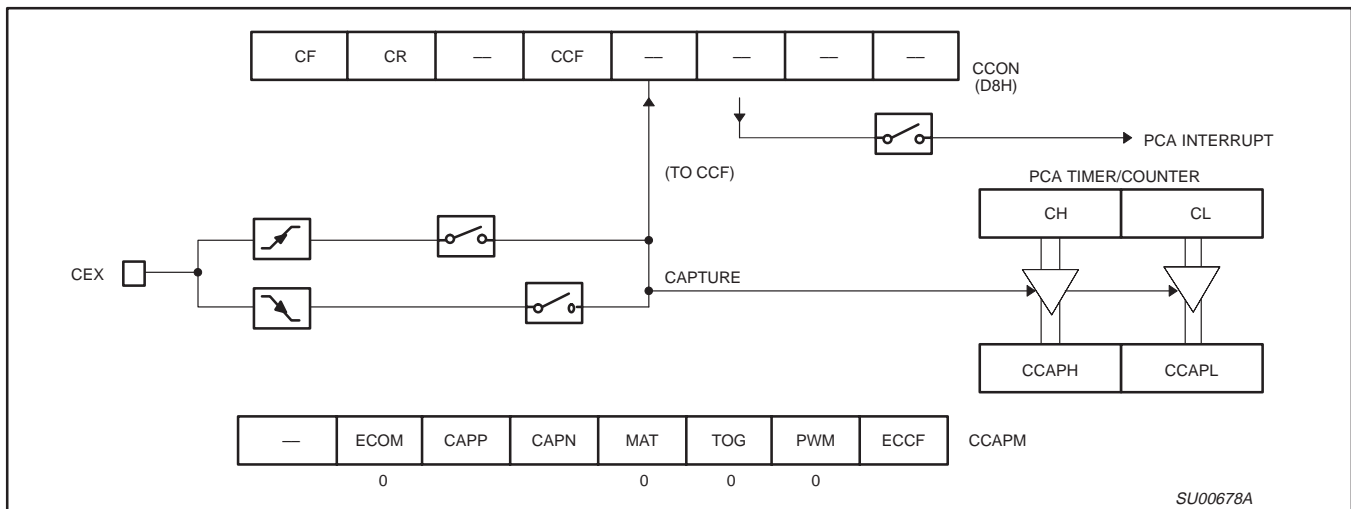

Figure 12. PCA Capture Mode

80C51 8-bit microcontroller family
 4K/256 OTP/ROM, DAC, comparator, UART, reference

83C754/87C754

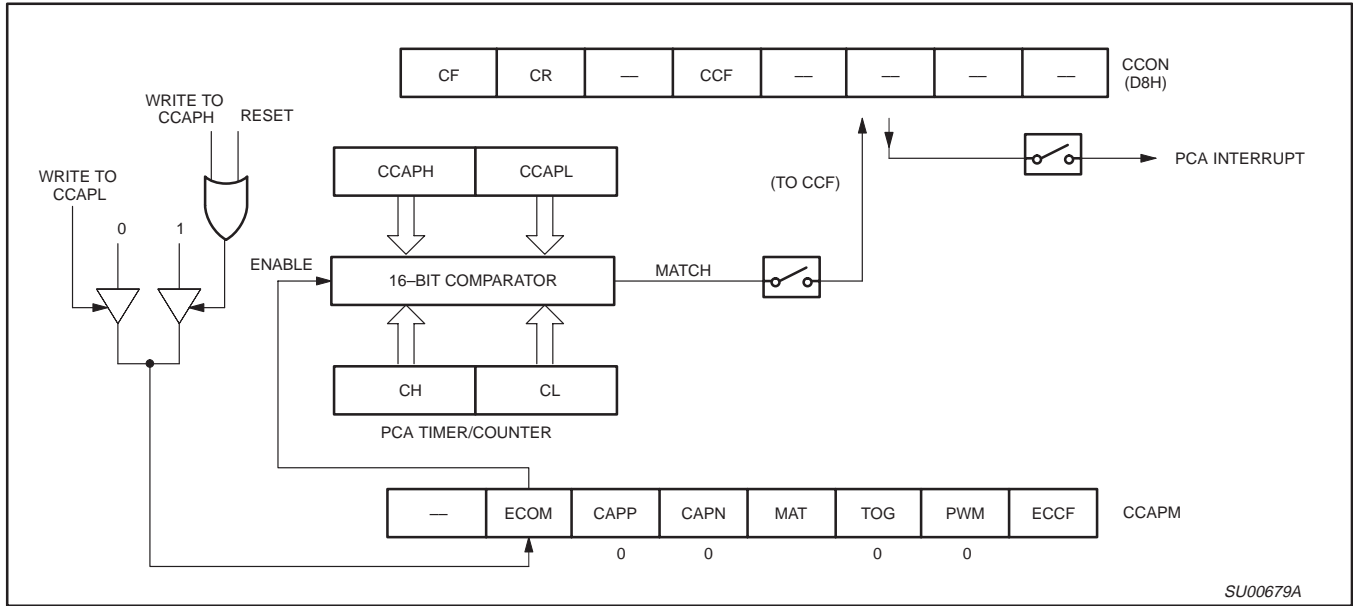

Figure 13. PCA Compare Mode

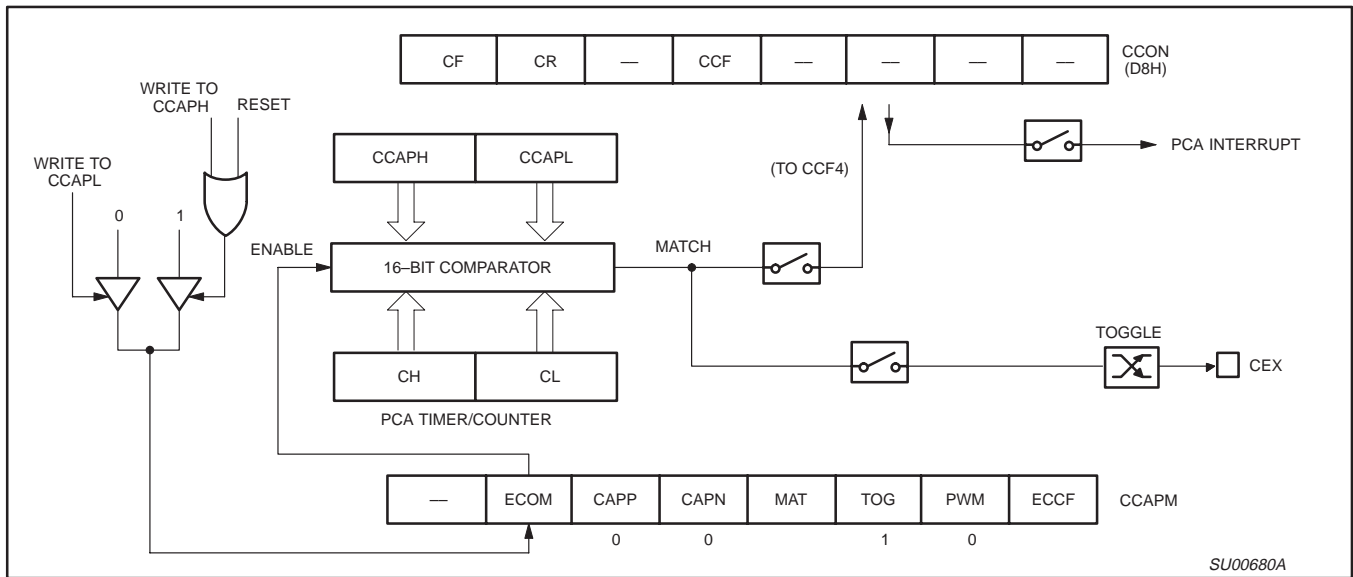

Figure 14. PCA High Speed Output Mode

80C51 8-bit microcontroller family
 4K/256 OTP/ROM, DAC, comparator, UART, reference

83C754/87C754

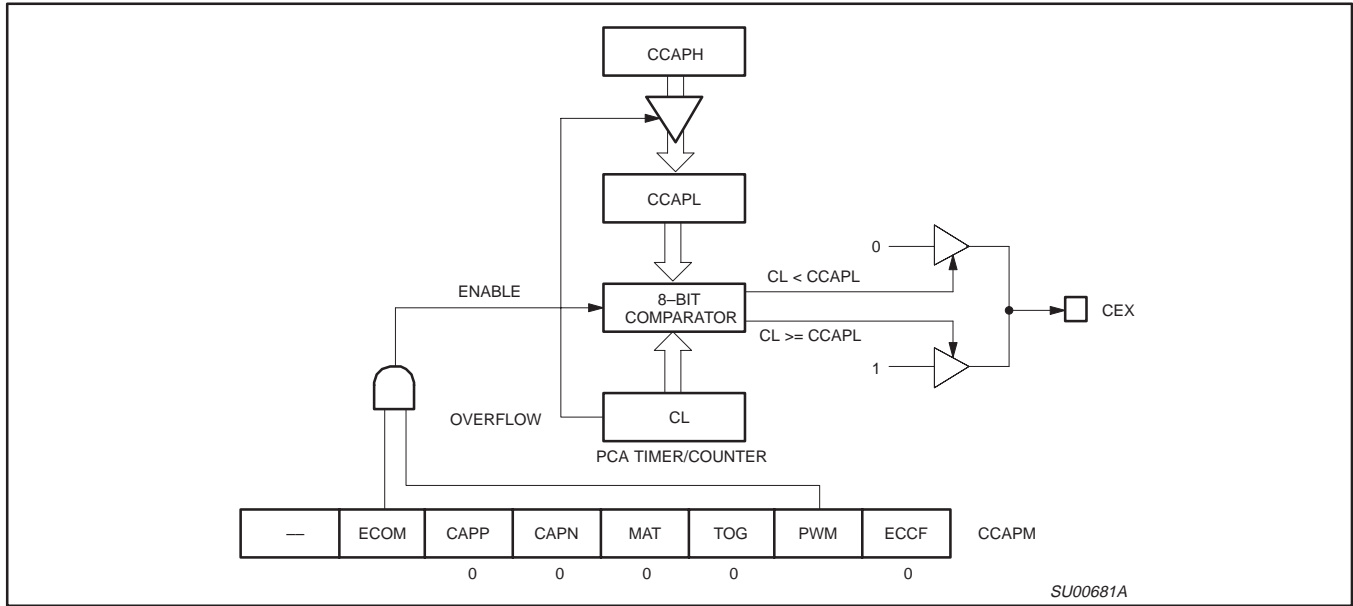

Figure 15. PCA PWM Mode

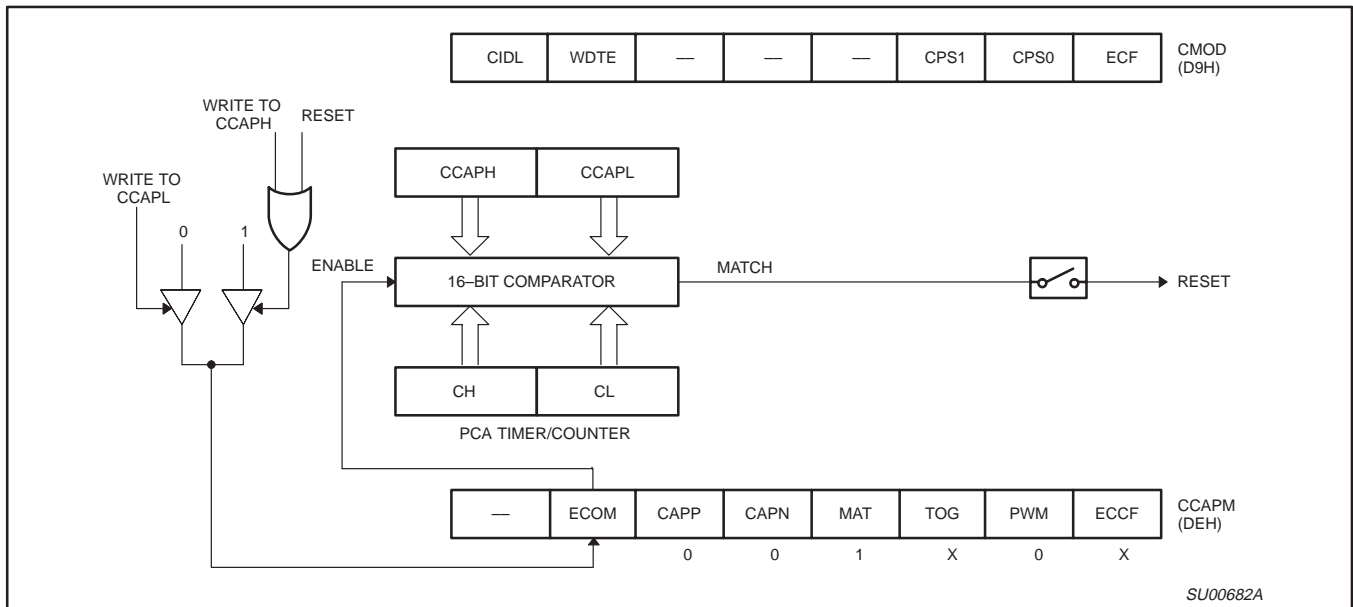

Figure 16. PCA Watchdog Timer

80C51 8-bit microcontroller family

4K/256 OTP/ROM, DAC, comparator, UART, reference

83C754/87C754

ABSOLUTE MAXIMUM RATINGS^{1, 3, 4}

PARAMETER	RATING	UNIT
Storage temperature range	-65 to +150	°C
Voltage from V_{CC} to V_{SS}	-0.5 to +6.5	V
Voltage from any pin to V_{SS} (except V_{PP})	-0.5 to $V_{CC} + 0.5$	V
Power dissipation	1.0	W
Voltage from V_{PP} pin to V_{SS}	-0.5 to + 13.0	V

DC ELECTRICAL CHARACTERISTICS $T_{amb} = 0^{\circ}\text{C}$ to $+70^{\circ}\text{C}$, $\Delta V_{CC} = 5\text{V} \pm 5$, $\Delta V_{SS} = 0\text{V}^4$ $V_{CC} = 5\text{V} \pm 10\%$, $V_{SS} = 0\text{V}$

SYMBOL	PARAMETER	TEST CONDITIONS	LIMITS ⁴			UNIT
			MIN	TYP ¹	MAX	
I_{CC}	Supply current (see Figure 19)					
Inputs						
V_{IL}	Input low voltage, port 1, 3		-0.5		$0.2V_{CC} - 0.1$	V
V_{IH}	Input high voltage, port 1, 3		$0.2V_{CC} + 0.9$		$V_{CC} + 0.5$	V
V_{IH1}	Input high voltage, X1, RST		$0.7V_{CC}$		$V_{CC} + 0.5$	V
Outputs						
V_{OL}	Output low voltage, port 3	$I_{OL} = 1.6\text{mA}^2$			0.45	V
V_{OL1}	Output low voltage, port 1.0, 1.1, 1.2	$I_{OL} = 3.2\text{mA}^2$			0.45	V
V_{OH}	Output high voltage, ports 3, 1.0, 1.1	$I_{OH} = -60\mu\text{A}$	2.4			V
I_{LI}	Input leakage current, port 1, 3, RST	$0.45 < V_{IN} < V_{CC}$			+10	μA
I_{IL}	Logical 0 input current, ports 1 and 3	$V_{IN} = 0.45\text{V}$			-50	μA
C_{IO}	Pin capacitance	Test freq = 1MHz, $T_{amb} = 25^{\circ}\text{C}$			10	pF
I_{PD}	Power-down current ⁵	$V_{CC} = 2$ to 5.5V $V_{CC} = 2$ to 6.0V (83C754)			50	μA
V_{PP}	V_{PP} program voltage (87C754 only)	$V_{SS} = 0\text{V}$ $V_{CC} = 5\text{V} \pm 10\%$ $T_{amb} = 21^{\circ}\text{C}$ to 27°C	12.5		13.0	V
I_{PP}	Program current (87C754 only)	$V_{PP} = 13.0\text{V}$			50	mA

NOTES:

- Stresses above those listed under Absolute Maximum Ratings may cause permanent damage to the device. This is a stress rating only and functional operation of the device at these or any conditions other than those described in the AC and DC Electrical Characteristics section of this specification is not implied.
- Under steady state (non-transient) conditions, I_{OL} must be externally limited as follows:

Maximum I_{OL} per port pin:	10mA
Maximum I_{OL} per 8-bit port:	26mA
Maximum total I_{OL} for all outputs:	67mA

 If I_{OL} exceeds the test condition, V_{OL} may exceed the related specification. Pins are not guaranteed to sink current greater than the listed test conditions.
- This product includes circuitry specifically designed for the protection of its internal devices from the damaging effects of excessive static charge. Nonetheless, it is suggested that conventional precautions be taken to avoid applying greater than the rated maxima.
- Parameters are valid over operating temperature range unless otherwise specified. All voltages are with respect to V_{SS} unless otherwise noted.
- Power-down I_{CC} is measured with all output pins disconnected; port 0 = V_{CC} ; X2, X1 n.c.; RST = V_{SS} .
- I_{CC} is measured with all output pins disconnected; X1 driven with t_{CLCH} , $t_{CHCL} = 5\text{ns}$, $V_{IL} = V_{SS} + 0.5\text{V}$, $V_{IH} = V_{CC} - 0.5\text{V}$; X2 n.c.; RST = port 0 = V_{CC} . I_{CC} will be slightly higher if a crystal oscillator is used.
- Idle I_{CC} is measured with all output pins disconnected; X1 driven with t_{CLCH} , $t_{CHCL} = 5\text{ns}$, $V_{IL} = V_{SS} + 0.5\text{V}$, $V_{IH} = V_{CC} - 0.5\text{V}$; X2 n.c.; port 0 = V_{CC} ; RST = V_{SS} .
- Load capacitance for ports = 80pF.

80C51 8-bit microcontroller family

4K/256 OTP/ROM, DAC, comparator, UART, reference

83C754/87C754

ANALOG SECTION ELECTRICAL CHARACTERISTICS

 $T_{amb} = 0^{\circ}\text{C to } +70^{\circ}\text{C}$, $AV_{CC} = 5\text{V} \pm 5\%$, $AV_{SS} = 0\text{V}^4$
 $V_{CC} = 5\text{V} \pm 10\%$, $V_{SS} = 0\text{V}$

SYMBOL	PARAMETER	TEST CONDITIONS	LIMITS ⁴			UNIT
			MIN	TYP ¹	MAX	
Analog Inputs (D/A guaranteed only with quartz window covered.)						
AV_{CC}	Analog supply voltage		4.5	–	5.5	V
	Sensor resistor		330	–	3K	Ω
$I_{AV_{CC}}$		$AC0 = 0$ IC only	–	0.88	1.5	mA
		$AC0 = 1$	–	–	10	μA
Regulator						
VREG			3.6	3.8	4.0	V
IVREG			13	–	55	mA
CDECOUPLE		Stability requirement	3	10	–	μF
RDSONQ1			–	7	–	Ω
ILEAKAGEQ1			–	TBD	–	μA
ILEAKAGEQ2			–	TBD	–	μA
PSRR		100Hz	–	–40	–	dB
VREGREJ	VREG rejection of 1 Volt AV_{CC} step change		–100	–	100	mV
TVREG	VREG turn on time	Q1 off, 330 Ω sensor	–	2	5	ms
MUX and Comparator						
	Comparator trip point		1.14	1.26	1.38	V
	Comparator delay input	0.04V/ μs	–	50	–	ns
	Comparator delay change	AV_{CC} 4.5 to 5.5V	–10	2	10	ns
	MUX impedance		–	1	–	k Ω
ILEAKAGEMUX			–	TBD	–	μA
Digital-to-Analog Conversion						
	ZDAC, XYDAC monotonicity		0	–	–	bits
	ZDAC, XYDAC impedance		–	10	–	k Ω
	DAC selection switch impedance		–	40	–	Ω
	DAC settling		–	1	–	μs
	ZDAC switch impedance		–	50	–	Ω
	ZDAC switch impedance change	AV_{CC} 4.5 to 5.5V	–20	–	20	Ω
	ZDAC switch leakage		–	TBD	–	μA
Switches						
	XYZRAMP impedance		–	25	100	Ω
	XYZRAMP impedance change	AV_{CC} 4.5 to 5.5V	–25	–	25	Ω
	XYZRAMP leakage		–	TBD	–	μA
	XYZRAMP discharge to 1LSB (1.6mV)		–	1.5	10	μs
	XYZRAMP delay turn on time		–	6	50	ns
	XYZRAMP start time change	AV_{CC} 4.5 to 5.5V	–10	–	10	ns
	XYDACBIAS impedance		–	7	13	Ω
	XYDACBIAS leakage		–	TBD	–	μA
	XYDACBIAS switching time		–	130	1000	ns
	XYSOURCE impedance		–	150	300	Ω
	XYSOURCE impedance change	AV_{CC} 4.5 to 5.5V	–100	–	100	Ω
	XYSOURCE leakage		–	TBD	–	μA
	XYSOURCE switching time		–	30	500	ns

80C51 8-bit microcontroller family
4K/256 OTP/ROM, DAC, comparator, UART, reference

83C754/87C754

AC ELECTRICAL CHARACTERISTICS

$T_{amb} = 0^{\circ}\text{C}$ to $+70^{\circ}\text{C}$, $V_{CC} = 5\text{V} \pm 10\%$, $V_{SS} = 0\text{V}^{4, 8}$

SYMBOL	PARAMETER	16MHz CLOCK		VARIABLE CLOCK		UNIT
		MIN	MAX	MIN	MAX	
$1/t_{CLCL}$	Oscillator frequency			3.5	16	MHz
External Clock (Figure 17)						
t_{CHCX}	High time	20		20		ns
t_{CLCX}	Low time	20		20		ns
t_{CLCH}	Rise time		20		20	ns
t_{CHCL}	Fall time		20		20	ns

EXPLANATION OF THE AC SYMBOLS

Each timing symbol has five characters. The first character is always 't' (= time). The other characters, depending on their positions, indicate the name of a signal or the logical status of that signal.

The designations are:

- C – Clock
- D – Input data
- H – Logic level high
- L – Logic level low
- Q – Output data
- T – Time
- V – Valid
- X – No longer a valid logic level
- Z – Float

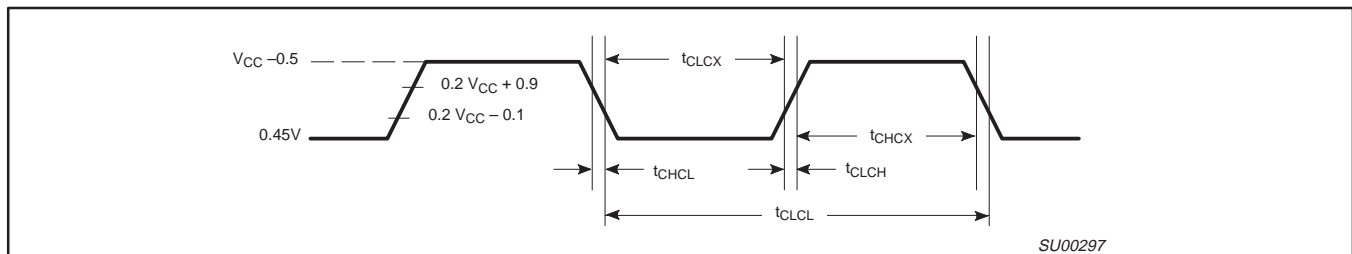

Figure 17. External Clock Drive

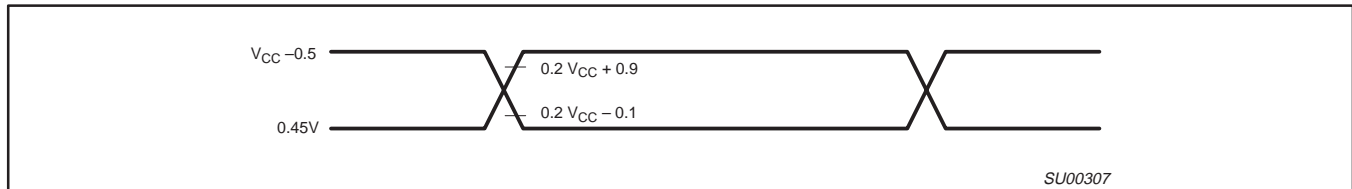

Figure 18. AC Testing Input/Output

80C51 8-bit microcontroller family
4K/256 OTP/ROM, DAC, comparator, UART, reference

83C754/87C754

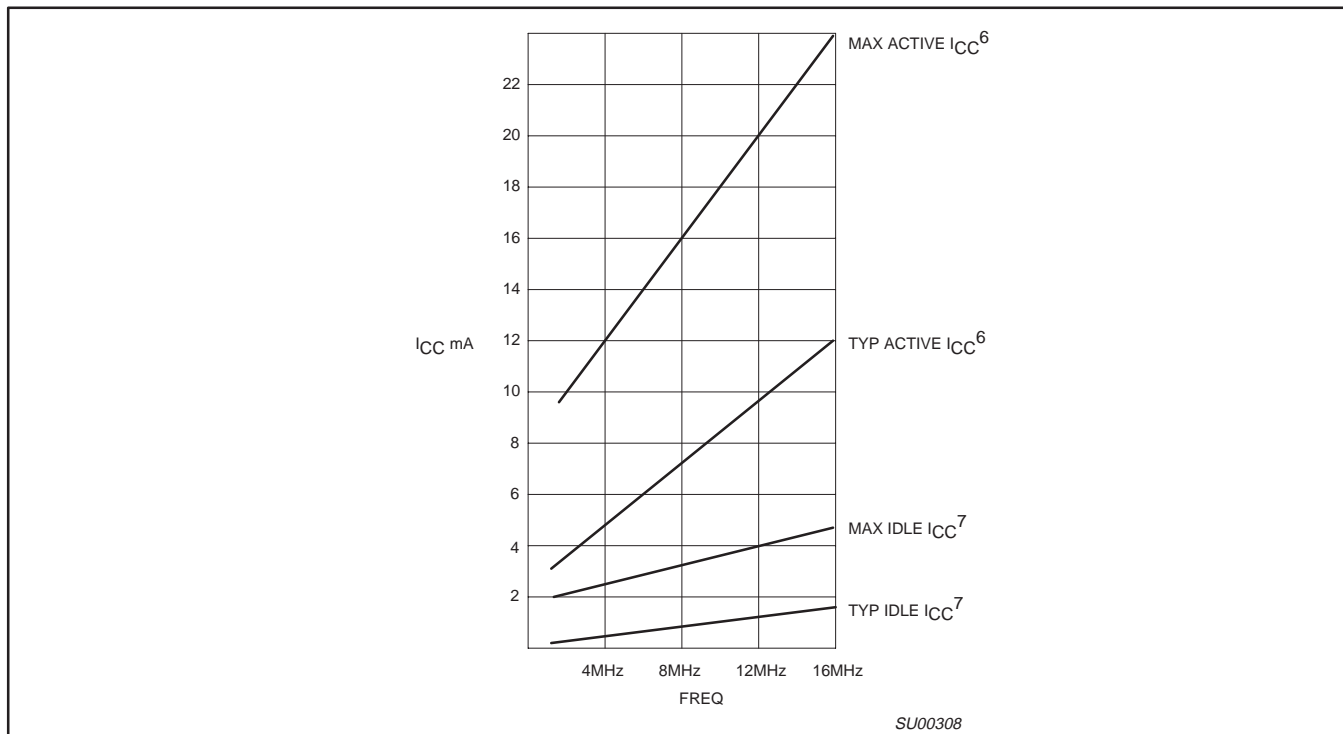

Figure 19. I_{CC} vs. FREQ
 Maximum I_{CC} values taken at V_{CC} = 5.5V and worst case temperature.
 Typical I_{CC} values taken at V_{CC} = 5.0V and 25°C.
 Notes 6 and 7 refer to AC Electrical Characteristics.

ROM CODE SUBMISSION

When submitting ROM code for the 83C754, the following must be specified:

1. 4k byte user ROM data
2. 64 byte ROM encryption key
3. ROM security bits.

ADDRESS	CONTENT	BIT(S)	COMMENT
0000H to 0FFFH	DATA	7:0	User ROM Data
1000H to 101FH	KEY	7:0	ROM Encryption Key FFH = no encryption
1020H	SEC	0	ROM Security Bit 1 0 = enable security 1 = disable security
1020H	SEC	1	ROM Security Bit 2 0 = enable security 1 = disable security

Security Bit 1: When programmed, this bit has two effects on masked ROM parts:

1. External MOVC is disabled, and
2. EA# is latched on Reset.

Security Bit 2: When programmed, this bit inhibits Verify User ROM.

If the ROM Code file does not include the options, the following information must be included with the ROM code.

For each of the following, check the appropriate box, and send to Philips along with the code:

- Security Bit #1: Enabled Disabled
- Security Bit #2: Enabled Disabled
- Encryption: No Yes If Yes, must send key file.

80C51 8-bit microcontroller family

4K/256 OTP/ROM, DAC, comparator, UART, reference

83C754/87C754

PROGRAMMING CONSIDERATIONS

EPROM Characteristics

The 87C754 is programmed by using a modified Quick-Pulse Programming algorithm similar to that used for devices such as the 87C751 and 87C752.

Figure 20 shows a block diagram of the programming configuration for the 87C754. Port pin P0.2 is used as the programming voltage supply input (V_{PP} signal). Port pin P0.1 is used as the program (PGM) signal. This pin is used for the 5 programming pulses.

Port 3 is used as the address input for the byte to be programmed and accepts both the high and low components of the eleven bit address. Multiplexing of these address components is performed using the ASEL input. The user should drive the ASEL input high and then drive port 3 with the high order bits of the address. ASEL should remain high for at least 13 clock cycles. ASEL may then be driven low which latches the high order bits of the address internally. The high address should remain on port 3 for at least two clock cycles after ASEL is driven low. Port 3 may then be driven with the low byte of the address. The low address will be internally stable 13 clock cycles later. The address will remain stable provided that the low byte placed on port 3 is held stable and ASEL is kept low.

Note: ASEL needs to be pulsed high only to change the high byte of the address.

Port 1 is used as a bidirectional data bus during programming and verify operations. During programming mode, it accepts the byte to be programmed. During verify mode, it provides the contents of the EPROM location specified by the address which has been supplied to Port 3.

The XTAL1 pin is the oscillator input and receives the master system clock. This clock should be between 1.2 and 16MHz.

The RESET pin is used to accept the serial data stream that places the 87C754 into various programming modes. This pattern consists of a 10-bit code with the LSB sent first. Each bit is synchronized to the clock input, X1.

Programming Operation

Figures 21 and 22 show the timing diagrams for the program/verify cycle. RESET should initially be held high for at least two machine cycles. P0.1 (PGM) and P0.2 (V_{PP}) will be at V_{OH} as a result of the RESET operation. At this point, these pins function as normal quasi-bidirectional I/O ports and the programming equipment may pull these lines low. However, prior to sending the 10-bit code on the RESET pin, the programming equipment should drive these pins high (V_{IH}). The RESET pin may now be used as the serial data input for the data stream which places the 87C754 in the programming mode. Data bits are sampled during the clock high time and thus should only change during the time that the clock is low. Following transmission of the last data bit, the RESET pin should be held low.

Next the address information for the location to be programmed is placed on port 3 and ASEL is used to perform the address multiplexing, as previously described. At this time, port 1 functions as an output.

A high voltage V_{PP} level is then applied to the V_{PP} input (P0.2). (This sets Port 1 as an input port). The data to be programmed into the EPROM array is then placed on Port 1. This is followed by a series of programming pulses applied to the PGM/ pin (P0.1). These pulses are created by driving P0.1 low and then high. This pulse is

repeated until a total of 5 programming pulses have occurred. At the conclusion of the last pulse, the PGM/ signal should remain high.

The V_{PP} signal may now be driven to the V_{OH} level, placing the 87C754 in the verify mode. (Port 1 is now used as an output port). After four machine cycles (48 clock periods), the contents of the addressed location in the EPROM array will appear on Port 1.

The next programming cycle may now be initiated by placing the address information at the inputs of the multiplexed buffers, driving the V_{PP} pin to the V_{PP} voltage level, providing the byte to be programmed to Port1 and issuing the 5 programming pulses on the PGM/ pin, bringing V_{PP} back down to the V_C level and verifying the byte.

Programming Modes

The 87C754 has four programming features incorporated within its EPROM array. These include the USER EPROM for storage of the application's code, a 64-byte encryption key array and two security bits. Programming and verification of these four elements are selected by a combination of the serial data stream applied to the RESET pin and the voltage levels applied to port pins P0.1 and P0.2. The various combinations are shown in Table 3.

Encryption Key Table

The 87C754 includes a 64-byte EPROM array that is programmable by the end user. The contents of this array can then be used to encrypt the program memory contents during a program memory verify operation. When a program memory verify operation is performed, the contents of the program memory location is XNOR'ed with one of the bytes in the 64-byte encryption table. The resulting data pattern is then provided to port 1 as the verify data. The encryption mechanism can be disabled, in essence, by leaving the bytes in the encryption table in their erased state (FFH) since the XNOR product of a bit with a logical one will result in the original bit. The encryption bytes are mapped with the code memory in 64-byte groups. the first byte in code memory will be encrypted with the first byte in the encryption table; the second byte in code memory will be encrypted with the second byte in the encryption table and so forth up to and including the 64th byte. The encryption repeats in 64-byte groups; the 65th byte in the code memory will be encrypted with the first byte in the encryption table, and so forth.

Security Bits

Two security bits, security bit 1 and security bit 2, are provided to limit access to the USER EPROM and encryption key arrays. Security bit 1 is the program inhibit bit, and once programmed performs the following functions:

1. Additional programming of the USER EPROM is inhibited.
2. Additional programming of the encryption key is inhibited.
3. Verification of the encryption key is inhibited.
4. Verification of the USER EPROM and the security bit levels may still be performed.

(If the encryption key array is being used, this security bit should be programmed by the user to prevent unauthorized parties from reprogramming the encryption key to all logical zero bits. Such programming would provide data during a verify cycle that is the logical complement of the USER EPROM contents).

Security bit 2, the verify inhibit bit, prevents verification of both the USER EPROM array and the encryption key arrays. The security bit levels may still be verified.

80C51 8-bit microcontroller family

4K/256 OTP/ROM, DAC, comparator, UART, reference

83C754/87C754

Programming and Verifying Security Bits

Security bits are programmed employing the same techniques used to program the USER EPROM and KEY arrays using serial data streams and logic levels on port pins indicated in Table 3. When programming either security bit, it is not necessary to provide address or data information to the 87C754 on ports 1 and 3.

Verification occurs in a similar manner using the RESET serial stream shown in Table 3. Port 3 is not required to be driven and the results of the verify operation will appear on ports 1.6 and 1.7.

Ports 1.7 contains the security bit 1 data and is a logical one if programmed and a logical zero if erased. Likewise, P1.6 contains the security bit 2 data and is a logical one if programmed and a logical zero if erased.

Erasure Characteristics

Erasure of the EPROM begins to occur when the chip is exposed to light with wavelengths shorter than approximately 4,000 angstroms.

Since sunlight and fluorescent lighting have wavelengths in this range, exposure to these light sources over an extended time (about 1 week in sunlight, or 3 years in room level fluorescent lighting) could cause inadvertent erasure. **For this and secondary effects, it is recommended that an opaque label be placed over the window.** For elevated temperature or environments where solvents are being used, apply Kapton tape Flourless part number 2345-5 or equivalent.

The recommended erasure procedure is exposure to ultraviolet light (at 2537 angstroms) to an integrated dose of at least 15W-sec/cm². Exposing the EPROM to an ultraviolet lamp of 12,000uW/cm² rating for 20 to 39 minutes, at a distance of about 1 inch, should be sufficient.

Erasure leaves the array in an all 1s state.

Table 3. Implementing Program/Verify Modes

OPERATION	SERIAL CODE	PGM	V _{PP}
Program user EPROM	296H	—*	V _{PP}
Verify user EPROM	296H	V _{IH}	V _{IH}
Program key EPROM	292H	—*	V _{PP}
Verify key EPROM	292H	V _{IH}	V _{IH}
Program security bit 1	29AH	—*	V _{PP}
Program security bit 2	298H	—*	V _{PP}
Verify security bits	29AH	V _{IH}	V _{IH}

NOTE:

* Pulsed from V_{IH} to V_{IL} and returned to V_{IH}.

80C51 8-bit microcontroller family
4K/256 OTP/ROM, DAC, comparator, UART, reference

83C754/87C754

EPROM PROGRAMMING AND VERIFICATION

$T_{amb} = 21^{\circ}\text{C}$ to $+27^{\circ}\text{C}$, $V_{CC} = 5\text{V} \pm 10\%$, $V_{SS} = 0\text{V}$

SYMBOL	PARAMETER	MIN	MAX	UNIT
$1/t_{CLCL}$	Oscillator/clock frequency	1.2	16	MHz
t_{AVGL}^1	Address setup to $\overline{\text{PGM}}$ low	$10\mu\text{s} + 24t_{CLCL}$		
t_{GHAX}	Address hold after $\overline{\text{PGM}}$ high	$48t_{CLCL}$		
t_{DVGL}	Data setup to $\overline{\text{PGM}}$ low	$38t_{CLCL}$		
t_{DVGL}	Data setup to $\overline{\text{PGM}}$ low	$38t_{CLCL}$		
t_{GHDX}	Data hold after $\overline{\text{PGM}}$ high	$36t_{CLCL}$		
t_{SHGL}	V_{PP} setup to $\overline{\text{PGM}}$ low	10		μs
t_{GHSL}	V_{PP} hold after $\overline{\text{PGM}}$	10		μs
t_{GLGH}	$\overline{\text{PGM}}$ width	90	110	μs
t_{AVQV}^2	V_{PP} low (V_{CC}) to data valid		$48t_{CLCL}$	
t_{GHGL}	$\overline{\text{PGM}}$ high to $\overline{\text{PGM}}$ low	10		μs
t_{SYNL}	P0.0 (sync pulse) low	$4t_{CLCL}$		
t_{SYNH}	P0.0 (sync pulse) high	$8t_{CLCL}$		
t_{MASEL}	ASEL high time	$13t_{CLCL}$		
t_{MAHLD}	Address hold time	$2t_{CLCL}$		
t_{HASET}	Address setup to ASEL	$13t_{CLCL}$		
t_{ADSTA}	Low address to address stable	$13t_{CLCL}$		

NOTES:

1. Address should be valid at least $24t_{CLCL}$ before the rising edge of V_{PP} .
2. For a pure verify mode, i.e., no program mode in between, t_{AVQV} is $14t_{CLCL}$ maximum.

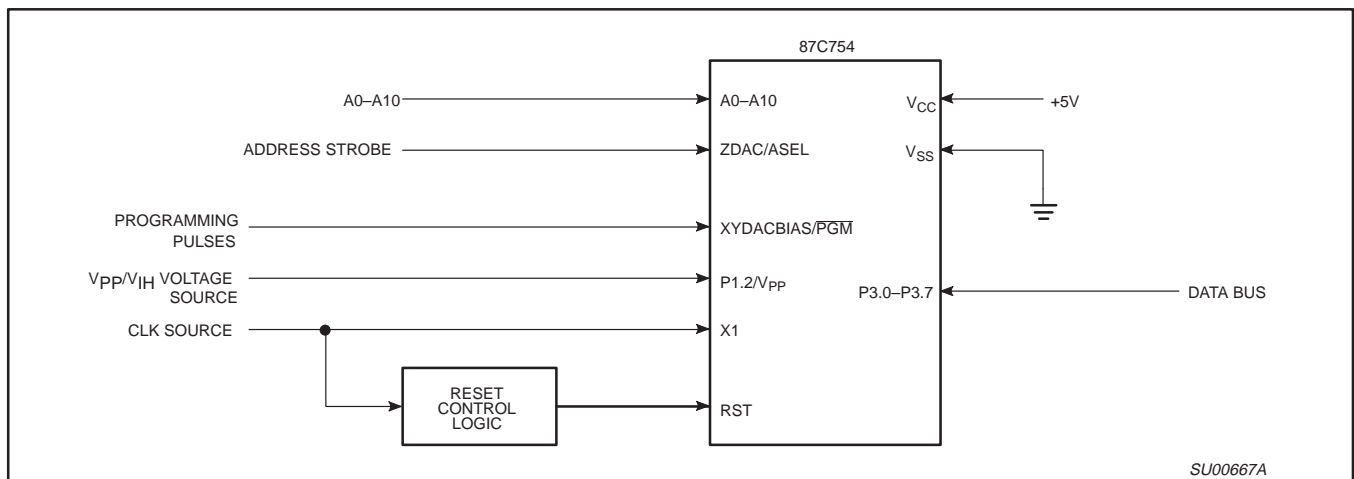

Figure 20. Programming Configuration

80C51 8-bit microcontroller family
 4K/256 OTP/ROM, DAC, comparator, UART, reference

83C754/87C754

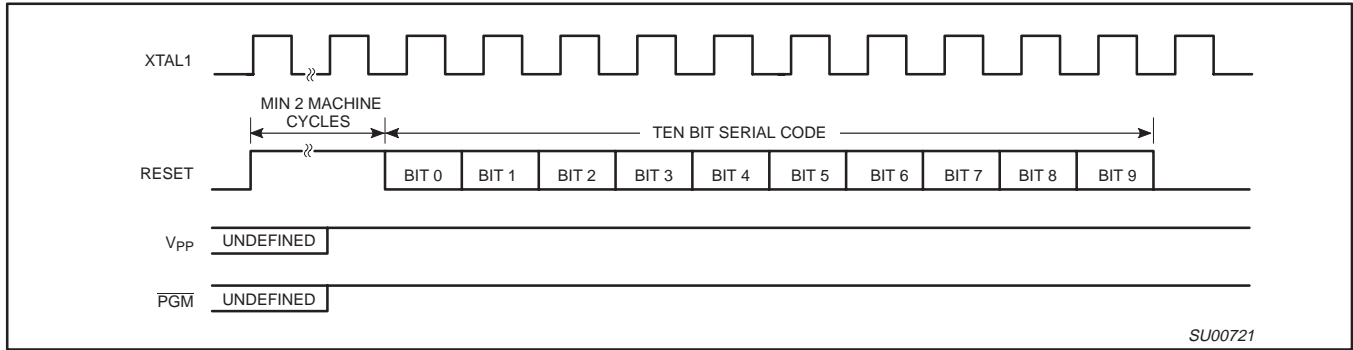

Figure 21. Entry into Program/Verify Modes

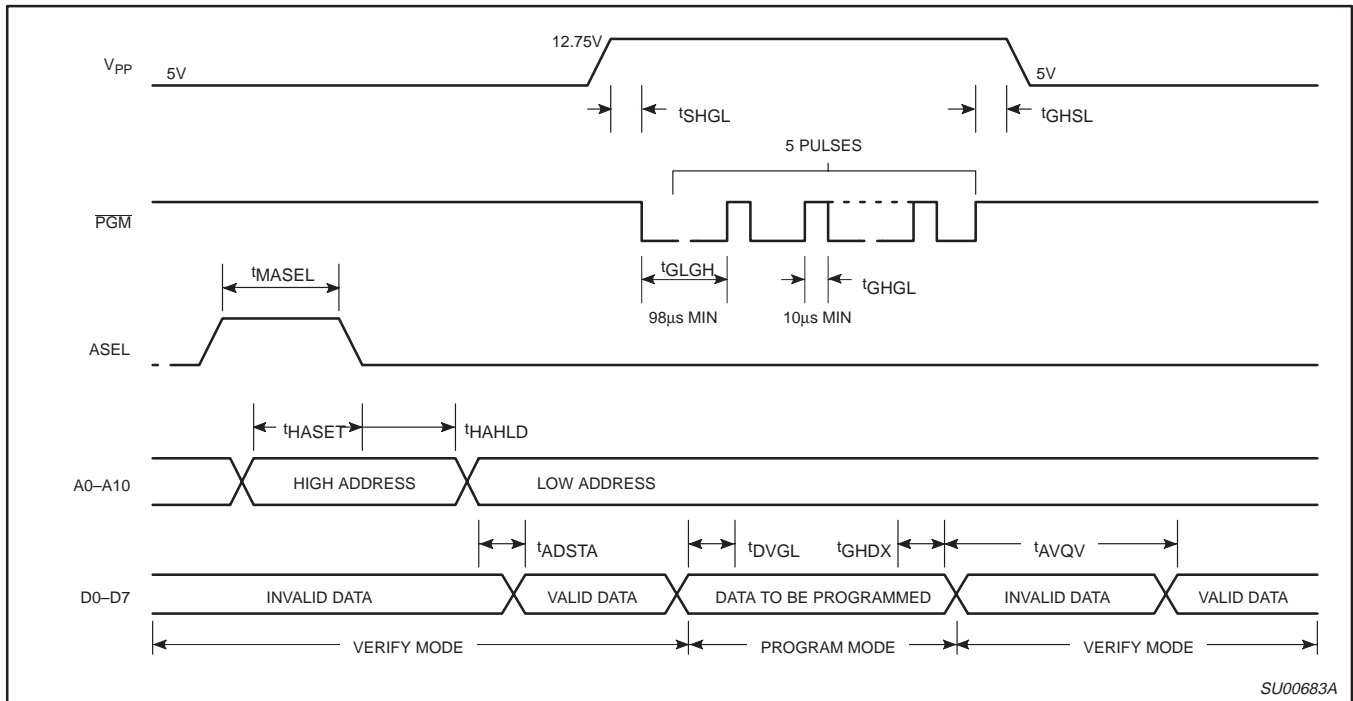

Figure 22. Program/Verify Cycle

80C51 8-bit microcontroller family
 4K/256 OTP/ROM, DAC, comparator, UART, reference

83C754/87C754

SSOP28: plastic shrink small outline package; 28 leads; body width 5.3mm

SOT341-1

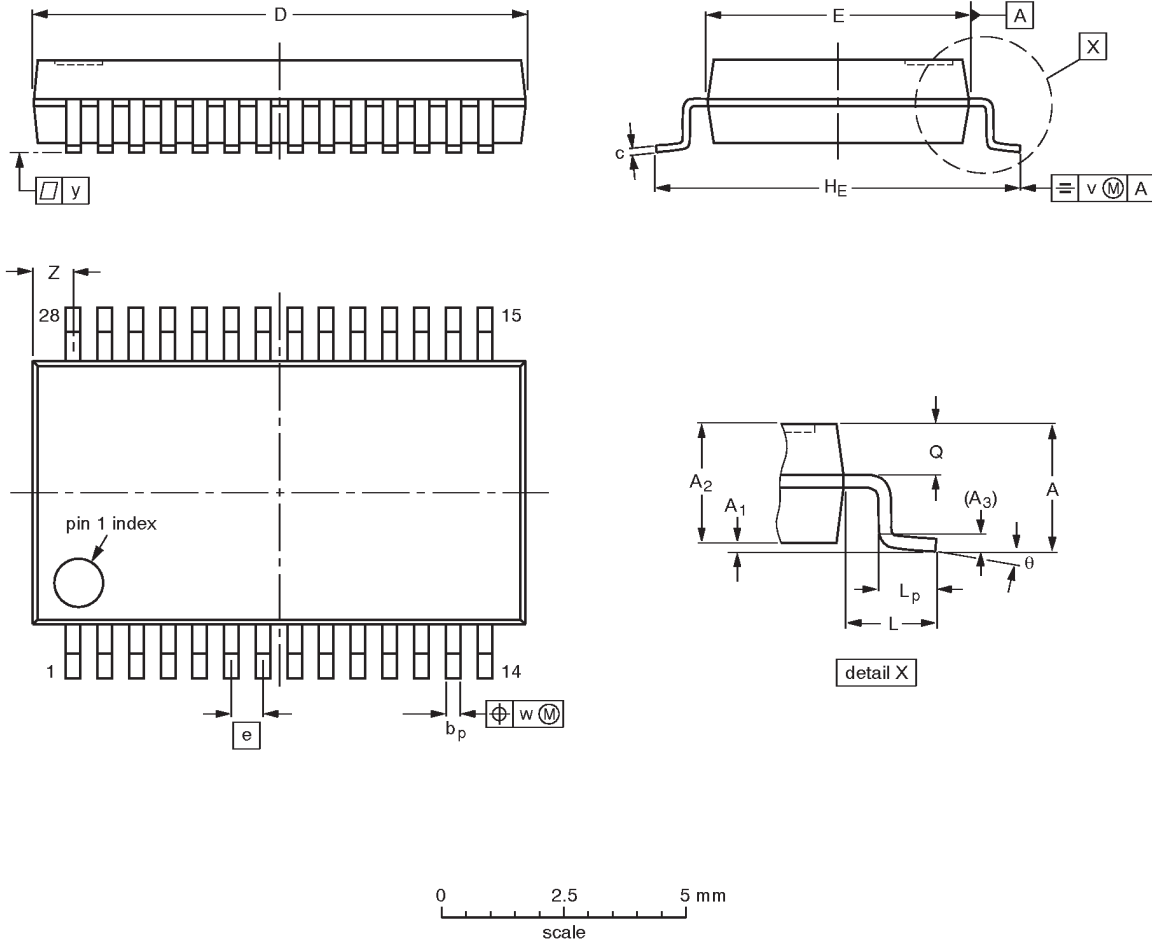

DIMENSIONS (mm are the original dimensions)

UNIT	A max.	A ₁	A ₂	A ₃	b _p	c	D ⁽¹⁾	E ⁽¹⁾	e	H _E	L	L _p	Q	v	w	y	Z ⁽¹⁾	θ
mm	2.0	0.21 0.05	1.80 1.65	0.25	0.38 0.25	0.20 0.09	10.4 10.0	5.4 5.2	0.65	7.9 7.6	1.25	1.03 0.63	0.9 0.7	0.2	0.13	0.1	1.1 0.7	8° 0°

Note

1. Plastic or metal protrusions of 0.20 mm maximum per side are not included.

OUTLINE VERSION	REFERENCES				EUROPEAN PROJECTION	ISSUE DATE
	IEC	JEDEC	EIAJ			
SOT341-1		MO-150AH				93-09-08 95-02-04

80C51 8-bit microcontroller family
4K/256 OTP/ROM, DAC, comparator, UART, reference

83C754/87C754

NOTES

80C51 8-bit microcontroller family

4K/256 OTP/ROM, DAC, comparator, UART, reference

83C754/87C754

Data sheet status

Data sheet status	Product status	Definition [1]
Objective specification	Development	This data sheet contains the design target or goal specifications for product development. Specification may change in any manner without notice.
Preliminary specification	Qualification	This data sheet contains preliminary data, and supplementary data will be published at a later date. Philips Semiconductors reserves the right to make changes at any time without notice in order to improve design and supply the best possible product.
Product specification	Production	This data sheet contains final specifications. Philips Semiconductors reserves the right to make changes at any time without notice in order to improve design and supply the best possible product.

[1] Please consult the most recently issued datasheet before initiating or completing a design.

Definitions

Short-form specification — The data in a short-form specification is extracted from a full data sheet with the same type number and title. For detailed information see the relevant data sheet or data handbook.

Limiting values definition — Limiting values given are in accordance with the Absolute Maximum Rating System (IEC 134). Stress above one or more of the limiting values may cause permanent damage to the device. These are stress ratings only and operation of the device at these or at any other conditions above those given in the Characteristics sections of the specification is not implied. Exposure to limiting values for extended periods may affect device reliability.

Application information — Applications that are described herein for any of these products are for illustrative purposes only. Philips Semiconductors make no representation or warranty that such applications will be suitable for the specified use without further testing or modification.

Disclaimers

Life support — These products are not designed for use in life support appliances, devices or systems where malfunction of these products can reasonably be expected to result in personal injury. Philips Semiconductors customers using or selling these products for use in such applications do so at their own risk and agree to fully indemnify Philips Semiconductors for any damages resulting from such application.

Right to make changes — Philips Semiconductors reserves the right to make changes, without notice, in the products, including circuits, standard cells, and/or software, described or contained herein in order to improve design and/or performance. Philips Semiconductors assumes no responsibility or liability for the use of any of these products, conveys no license or title under any patent, copyright, or mask work right to these products, and makes no representations or warranties that these products are free from patent, copyright, or mask work right infringement, unless otherwise specified.

Philips Semiconductors
811 East Arques Avenue
P.O. Box 3409
Sunnyvale, California 94088-3409
Telephone 800-234-7381

© Copyright Philips Electronics North America Corporation 1998
All rights reserved. Printed in U.S.A.

Date of release: 05-98

Document order number:

9397 750 03892

Let's make things better.