

### FEATURES

#### 26 reset threshold options:

2.5 V to 5 V in 100 mV increments

#### 4 reset timeout options:

1 ms, 20 ms, 140 ms, and 1120 ms (min)

#### 4 watchdog timeout options:

6.3 ms, 102 ms, 1600 ms, and 25.6s (typ)

#### Manual reset input

#### Reset output stages:

Push-pull active-low

Open-drain active-low

Push-pull active-high

#### Low power consumption (5 $\mu$ A)

#### Guaranteed reset output valid to $V_{CC} = 1$ V

#### Power supply glitch immunity

#### Specified over industrial temperature range

#### 5-lead SOT-23 package

### APPLICATIONS

Microprocessor systems

Computers

Controllers

Intelligent instruments

Portable equipment

### GENERAL DESCRIPTION

The ADM6316/ADM6317/ADM6318/ADM6319/ADM6320/ADM6321/ADM6322 are supervisory circuits, which monitor power supply voltage levels and code execution integrity in microprocessor-based systems. As well as providing power on reset signals, an on-chip watchdog timer can reset the microprocessor if it fails to strobe within a preset timeout period. A reset signal can also be asserted by an external push-button, through a manual reset input. The seven parts feature different combinations of watchdog input, manual reset input, and output stage configuration, as shown in Table 1.

Table 1. Selection Table

Part No.	Watchdog	Manual Reset	Output Stage	
			RESET	RESET
ADM6316	Yes	Yes	Push-Pull	–
ADM6317	Yes	Yes	–	Push-Pull
ADM6318	Yes	–	Push-Pull	Push-Pull
ADM6319	–	Yes	Push-Pull	Push-Pull
ADM6320	Yes	Yes	Open-Drain	–
ADM6321	Yes	–	Open-Drain	Push-Pull
ADM6322	–	Yes	Open-Drain	Push-Pull

#### Rev. 0

Information furnished by Analog Devices is believed to be accurate and reliable. However, no responsibility is assumed by Analog Devices for its use, nor for any infringements of patents or other rights of third parties that may result from its use. Specifications subject to change without notice. No license is granted by implication or otherwise under any patent or patent rights of Analog Devices. Trademarks and registered trademarks are the property of their respective owners.

### FUNCTIONAL BLOCK DIAGRAM

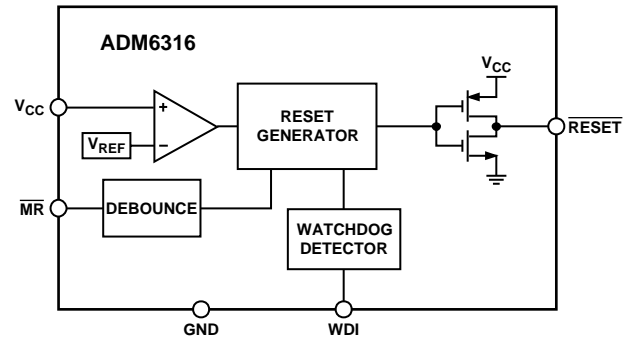

Figure 1.

Each part is available in a choice of 26 reset threshold options ranging from 2.5 V to 5 V in 100 mV increments. There are also four reset timeout options of 1 ms, 20 ms, 140 ms, and 1120 ms (min) and four watchdog timeout options of 6.3 ms, 102 ms, 1600 ms, and 25.6s (typ).

The ADM6316–ADM6322 are available in 5-lead SOT-23 packages and typically consume only 3  $\mu$ A, making them suitable for use in low power portable applications.

## TABLE OF CONTENTS

Specifications.....	3	Watchdog Input .....	10
Absolute Maximum Ratings.....	5	Application Information.....	11
ESD Caution.....	5	Watchdog Input Current .....	11
Pin Configurations and Function Descriptions .....	6	Negative-Going $V_{CC}$ Transients .....	11
Typical Performance Characteristics .....	7	Ensuring Reset Valid to $V_{CC} = 0 V$ .....	11
Circuit Description.....	10	Watchdog Software Considerations.....	11
Reset Output .....	10	Outline Dimensions .....	12
Open-Drain $\overline{\text{RESET}}$ Output.....	10	Ordering Guide .....	12
Manual Reset Input .....	10		

## REVISION HISTORY

10/04—Revision 0: Initial Version

# ADM6316/ADM6317/ADM6318/ADM6319/ADM6320/ADM6321/ADM6322

## SPECIFICATIONS

$V_{CC}$  = full operating range,  $T_A$  =  $T_{MIN}$  to  $T_{MAX}$ , unless otherwise noted.

**Table 2.**

Parameter	Min	Typ	Max	Unit	Test Conditions/Comments
<b>SUPPLY</b>					
$V_{CC}$ Operating Voltage Range	1		5.5	V	
Supply Current		10	20	$\mu$ A	$V_{CC} = 5.5$ V
		5	12	$\mu$ A	$V_{CC} = 3.6$ V
RESET THRESHOLD VOLTAGE	$V_{TH} - 1.5\%$	$V_{TH}$	$V_{TH} + 1.5\%$	V	$T_A = +25^\circ\text{C}$
	$V_{TH} - 2.5\%$	$V_{TH}$	$V_{TH} + 2.5\%$	V	$T_A = -40^\circ\text{C}$ to $+85^\circ\text{C}$
RESET THRESHOLD TEMPERATURE COEFFICIENT		40		ppm/ $^\circ\text{C}$	
RESET THRESHOLD HYSTERESIS		3		mV	
<b>RESET TIMEOUT PERIOD</b>					
ADM63__A	1	1.4	2	ms	
ADM63__B	20	28	40	ms	
ADM63__C	140	200	280	ms	
ADM63__D	1120	1600	2240	ms	
$V_{CC}$ TO RESET DELAY		40		$\mu$ s	$V_{CC}$ falling at 1 mV/ $\mu$ s
<b>PUSH-PULL OUTPUT (ADM6316, ADM6317, ADM6318, ADM6319, ADM6321, ADM6322)</b>					
RESET Output Voltage			0.3	V	$V_{CC} \geq 1.0$ V, $I_{SINK} = 50$ $\mu$ A
			0.3	V	$V_{CC} \geq 1.2$ V, $I_{SINK} = 100$ $\mu$ A
			0.3	V	$V_{CC} \geq 2.7$ V, $I_{SINK} = 1.2$ mA
			0.4	V	$V_{CC} \geq 4.5$ V, $I_{SINK} = 3.2$ mA
	$0.8 \times V_{CC}$			V	$V_{CC} \geq 2.7$ V, $I_{SOURCE} = 500$ $\mu$ A
	$V_{CC} - 1.5$			V	$V_{CC} \geq 4.5$ V, $I_{SOURCE} = 800$ $\mu$ A
RESET Rise Time		5	25	ns	From 10% to 90% $V_{CC}$ , $C_L = 5$ pF, $V_{CC} = 3.3$ V
RESET Output Voltage			0.3	V	$V_{CC} \geq 2.7$ V, $I_{SINK} = 1.2$ mA
			0.4	V	$V_{CC} \geq 4.5$ V, $I_{SINK} = 3.2$ mA
	$0.8 \times V_{CC}$			V	$V_{CC} \geq 1.8$ V, $I_{SOURCE} = 150$ $\mu$ A
	$0.8 \times V_{CC}$			V	$V_{CC} \geq 2.7$ V, $I_{SOURCE} = 500$ $\mu$ A
	$V_{CC} - 1.5$			V	$V_{CC} \geq 4.5$ V, $I_{SOURCE} = 800$ $\mu$ A
<b>OPEN-DRAIN OUTPUT (ADM6320, ADM6321, ADM6322)</b>					
RESET Output Voltage			0.3	V	$V_{CC} \geq 1.0$ V, $I_{SINK} = 50$ $\mu$ A
			0.3	V	$V_{CC} \geq 1.2$ V, $I_{SINK} = 100$ $\mu$ A
			0.3	V	$V_{CC} \geq 2.7$ V, $I_{SINK} = 1.2$ mA
			0.4	V	$V_{CC} \geq 4.5$ V, $I_{SINK} = 3.2$ mA
Open-Drain Reset Output Leakage Current			1	$\mu$ A	
<b>WATCHDOG INPUT (ADM6316, ADM6317, ADM6318, ADM6320, ADM6321)</b>					
Watchdog Timeout Period	4.3	6.3	9.3	ms	ADM63__W
	71	102	153	ms	ADM63__X
	1.12	1.6	2.4	s	ADM63__Y
	17.9	25.6	38.4	s	ADM63__Z
WDI Pulse Width	50			ns	$V_{IL} = 0.3 \times V_{CC}$ , $V_{IH} = 0.7 \times V_{CC}$
WDI Input Threshold	$0.3 \times V_{CC}$		$0.7 \times V_{CC}$	V	
WDI Input Current		120	160	$\mu$ A	$V_{WDI} = V_{CC}$ , time average
	-20	-15		$\mu$ A	$V_{WDI} = 0$ , time average

# ADM6316/ADM6317/ADM6318/ADM6319/ADM6320/ADM6321/ADM6322

Parameter	Min	Typ	Max	Unit	Test Conditions/Comments
MANUAL RESET INPUT (ADM6316, ADM6317, ADM6319, ADM6320, ADM6322)					
$\overline{\text{MR}}$ Input Threshold	0.8		2.0	V	$V_{\text{TH}} > 4.0 \text{ V}$
	$0.3 \times V_{\text{CC}}$		$0.7 \times V_{\text{CC}}$	V	$V_{\text{TH}} < 4.0 \text{ V}$
$\overline{\text{MR}}$ Input Pulse Width	1			$\mu\text{s}$	
$\overline{\text{MR}}$ Glitch Rejection		100		ns	
$\overline{\text{MR}}$ Pull-up Resistance	35	52	75	$\text{k}\Omega$	
$\overline{\text{MR}}$ to Reset Delay		230		ns	$V_{\text{CC}} = 5 \text{ V}$

## ABSOLUTE MAXIMUM RATINGS

$T_A = 25^\circ\text{C}$ , unless otherwise noted.

**Table 3.**

Parameter	Rating
$V_{CC}$	-0.3 V to +6 V
$\overline{\text{RESET}}$ (ADM6320, ADM6321, ADM6322)	-0.3 V to +6 V
All Other Pins	-0.3 V to ( $V_{CC} + 0.3$ V)
Output Current ( $\overline{\text{RESET}}$ , $\overline{\text{RESET}}$ )	20 mA
Operating Temperature Range	-40°C to +85°C
Storage Temperature Range	-65°C to +125°C
$\theta_{JA}$ Thermal Impedance, SOT-23	270°C/W
Lead Temperature	
Soldering (10 s)	300°C
Vapour Phase (60 s)	215°C
Infrared (15 s)	220°C

Stresses above those listed under Absolute Maximum Ratings may cause permanent damage to the device. This is a stress rating only; functional operation of the device at these or any other conditions above those indicated in the operational section of this specification is not implied. Exposure to absolute maximum rating conditions for extended periods may affect device reliability.

### ESD CAUTION

ESD (electrostatic discharge) sensitive device. Electrostatic charges as high as 4000 V readily accumulate on the human body and test equipment and can discharge without detection. Although this product features proprietary ESD protection circuitry, permanent damage may occur on devices subjected to high energy electrostatic discharges. Therefore, proper ESD precautions are recommended to avoid performance degradation or loss of functionality.



# ADM6316/ADM6317/ADM6318/ADM6319/ADM6320/ADM6321/ADM6322

## PIN CONFIGURATIONS AND FUNCTION DESCRIPTIONS

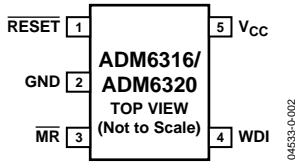

Figure 2. ADM6316/ADM6320 Pin Configuration

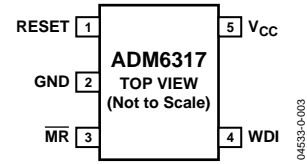

Figure 3. ADM6317 Pin Configuration

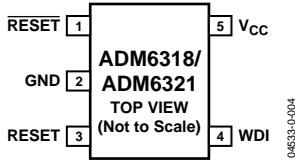

Figure 4. ADM6318/ADM6321 Pin Configuration

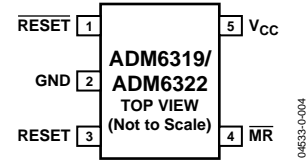

Figure 5. ADM6319/ADM6322 Pin Configuration

Table 4. Pin Function Descriptions

Pin No.	Mnemonic	Description
1	RESET (ADM6316/ADM6318/ ADM6319/ADM6320/ADM6321/ ADM6322) RESET (ADM6317)	Active-Low Reset Output. Asserted whenever $V_{CC}$ is below the reset threshold, $V_{TH}$ . Push-Pull Output Stage for the ADM6316/ADM6318/ADM6319. Open-Drain Output Stage for the ADM6320/ADM6321/ADM6322. Active-High, Push-Pull Reset Output.
2	GND	Ground.
3	$\overline{MR}$ (ADM6316/ADM6317/ ADM6320) RESET (ADM6318/ADM6319/ ADM6321/ADM6322)	Manual Reset Input. This is an active-low input which, when forced low for at least 1 $\mu$ s, generates a reset. It features a 52 k $\Omega$ internal pull-up. Active-High, Push-Pull Reset Output.
4	WDI (ADM6316/ADM6317/ ADM6318/ADM6320/ADM6321) $\overline{MR}$ (ADM6319/ADM6322)	Watchdog Input. Generates a reset if the logic level on the pin remains low or high for the duration of the watchdog timeout. The timer is cleared if a logic transition occurs on this pin or if a reset is generated. Leave floating to disable the watchdog timer. Manual Reset Input.
5	$V_{CC}$	Power Supply Voltage Being Monitored.

## TYPICAL PERFORMANCE CHARACTERISTICS

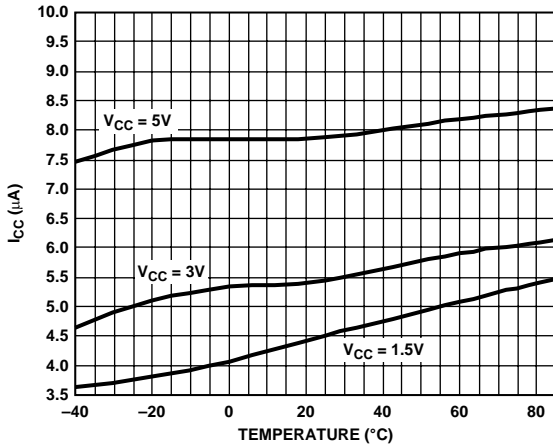

Figure 6. Supply Current vs. Temperature (ADM6316/ADM6317/ADM6318/ADM6320/ADM6321)

04533-0-006

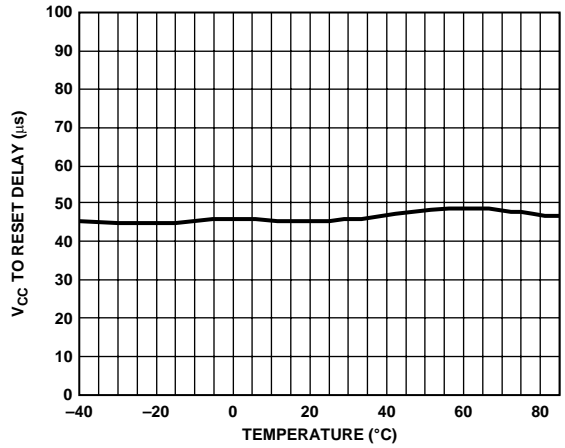

Figure 9.  $V_{CC}$  Falling to Reset Propagation Delay vs. Temperature

04533-0-008

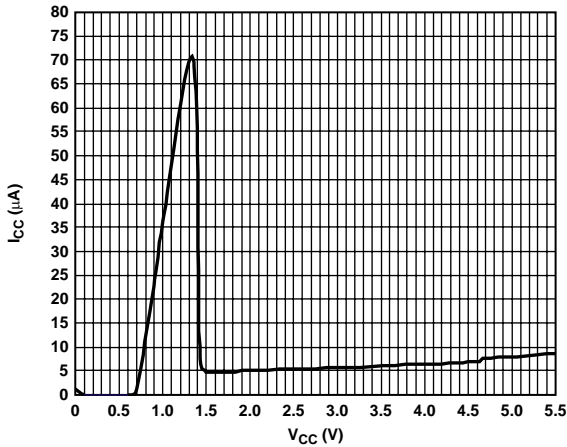

Figure 7. Supply Current vs. Supply Voltage

04533-0-007

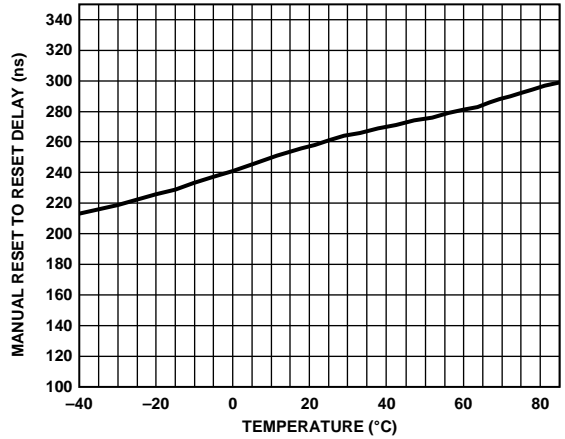

Figure 10. Manual Reset to Reset Propagation Delay vs. Temperature (ADM6316/ADM6317/ADM6319/ADM6320/ADM6322)

04533-0-010

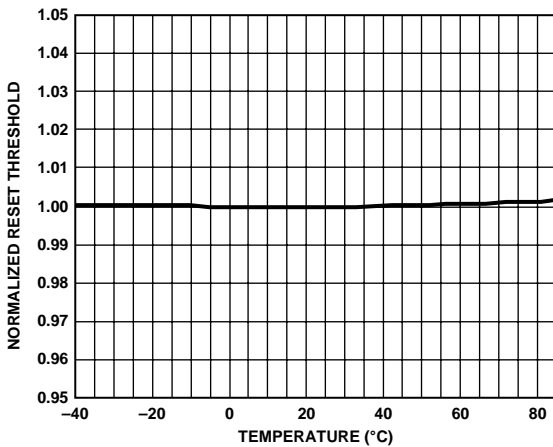

Figure 8. Normalized Reset Threshold vs. Temperature

04533-0-008

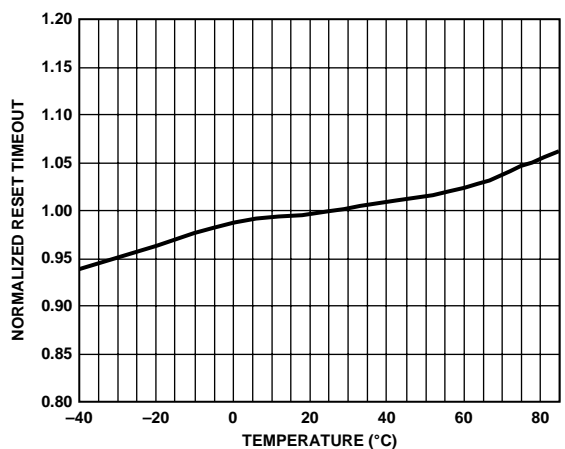
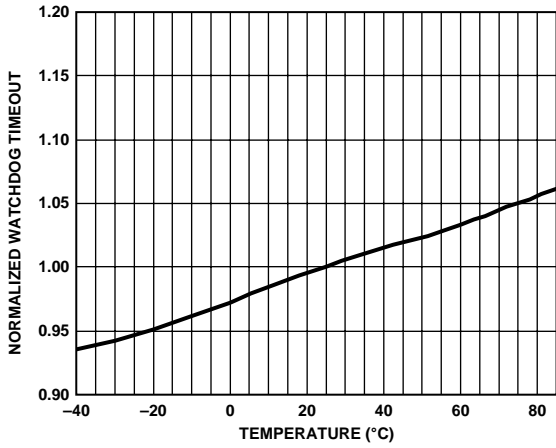

Figure 11. Normalized Reset Timeout Period vs. Temperature

04533-0-011



04533-0-012

Figure 12. Normalized Watchdog Timeout Period vs. Temperature (ADM6316/ADM6317/ADM6318/ADM6320/ADM6321)

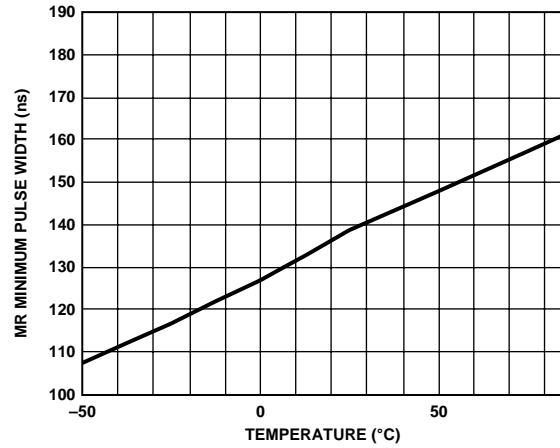

04533-0-014

Figure 14. Manual Reset Minimum Pulse Width vs. Temperature (ADM6316/ADM6317/ADM6319/ADM6320/ADM6322)

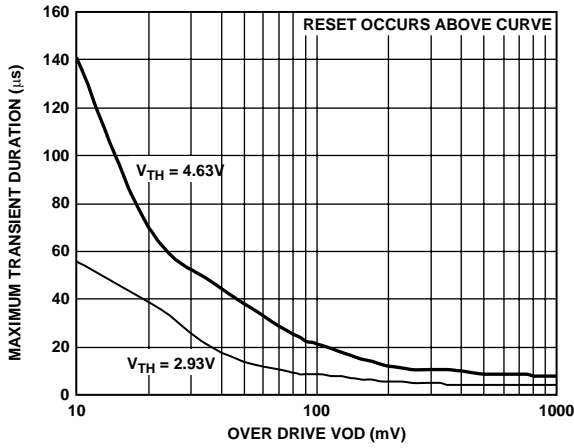

04533-0-013

Figure 13. Maximum V<sub>CC</sub> Transient Duration vs. Reset Threshold Overdrive

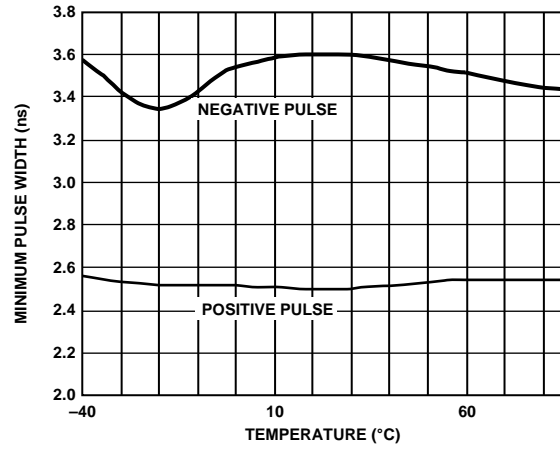

04333-0-015

Figure 15. Watchdog Input Minimum Pulse Width vs. Temperature (ADM6316/ADM6317/ADM6318/ADM6320/ADM6321)



# ADM6316/ADM6317/ADM6318/ADM6319/ADM6320/ADM6321/ADM6322

**Table 5. Reset Threshold Options**

Part No.	T <sub>A</sub> = +25°C			T <sub>A</sub> = -40°C to +85°C	
	Min	Typ	Max	Min	Max
ADM63 ___ 50	4.925	5.000	5.075	4.875	5.125
ADM63 ___ 49	4.827	4.900	4.974	4.778	5.023
ADM63 ___ 48	4.728	4.800	4.872	4.680	4.920
ADM63 ___ 47	4.630	4.700	4.771	4.583	4.818
ADM63 ___ 46	4.561	4.630	4.699	4.514	4.746
ADM63 ___ 45	4.433	4.500	4.568	4.388	4.613
ADM63 ___ 44	4.314	4.390	4.446	4.270	4.490
ADM63 ___ 43	4.236	4.300	4.365	4.193	4.408
ADM63 ___ 42	4.137	4.200	4.263	4.095	4.305
ADM63 ___ 41	4.039	4.100	4.162	3.998	4.203
ADM63 ___ 40	3.940	4.00	4.060	3.900	4.100
ADM63 ___ 39	3.842	3.900	3.959	3.803	3.998
ADM63 ___ 38	3.743	3.800	3.857	3.705	3.895
ADM63 ___ 37	3.645	3.700	3.756	3.608	3.793
ADM63 ___ 36	3.546	3.600	3.654	3.510	3.690
ADM63 ___ 35	3.448	3.500	3.553	3.413	3.588
ADM63 ___ 34	3.349	3.400	3.451	3.315	3.485
ADM63 ___ 33	3.251	3.300	3.350	3.218	3.383
ADM63 ___ 32	3.152	3.200	3.248	3.120	3.280
ADM63 ___ 31	3.034	3.080	3.126	3.003	3.157
ADM63 ___ 30	2.955	3.000	3.045	2.925	3.075
ADM63 ___ 29	2.886	2.930	2.974	2.857	3.000
ADM63 ___ 28	2.758	2.800	2.842	2.730	2.870
ADM63 ___ 27	2.660	2.700	2.741	2.633	2.768
ADM63 ___ 26	2.591	2.630	2.669	2.564	2.696
ADM63 ___ 25	2.463	2.500	2.538	2.438	2.563

**Table 6. Reset Timeout Options**

Suffix	Min	Typ	Max	Unit
A	1	1.6	2	ms
B	20	30	40	ms
C	140	200	280	ms
D	1.12	1.60	2.24	s

**Table 7. Watchdog Timer Options**

Suffix	Min	Typ	Max	Unit
W	4.3	6.3	9.3	ms
X	71	102	153	ms
Y	1.12	1.6	2.24	s
Z	17.9	25.6	38.4	s

**Table 8. Standard Models**

Model	Reset Threshold (V)	Minimum Reset Timeout (ms)	Typical Watchdog Timeout (s)
ADM6316CY29ARJ	2.93	140	1.6
ADM6316CY46ARJ	4.63	140	1.6
ADM6318CY46ARJ	4.63	140	1.6
ADM6319C46ARJ	4.63	140	1.6
ADM6320CY29ARJ	2.93	140	1.6
ADM6320CY46ARJ	4.63	140	1.6
ADM6321CY46ARJ	4.63	140	1.6
ADM6322C46ARJ	4.63	140	1.6

## CIRCUIT DESCRIPTION

The ADM6316/ADM6317/ADM6318/ADM6319/ADM6320/ADM6321/ADM6322 provide microprocessor supply voltage supervision by controlling the microprocessor's reset input. Code execution errors are avoided during power-up, power-down, and brownout conditions by asserting a reset signal when the supply voltage is below a preset threshold and by allowing supply voltage stabilization with a fixed-timeout reset pulse after the supply voltage rises above the threshold. In addition, problems with microprocessor code execution can be monitored and corrected with a watchdog timer (ADM6316/ADM6317/ADM6318/ADM6320/ADM6321). If the user detects a problem with the system's operation, a manual reset input is available (ADM6316/ADM6317/ADM6319/ADM6320/ADM6322) to reset the microprocessor by means of an external push-button, for example.

### RESET OUTPUT

The ADM6316 features an active-low, push-pull reset output, while the ADM6317/ADM6321/ADM6322 have active-high push-pull reset outputs. The ADM6318/ADM6319 feature dual active-low and active-high push-pull reset outputs. For active-low and active-high outputs, the reset signal is guaranteed to be logic low and logic high, respectively, for  $V_{CC}$  down to 1 V.

The reset output is asserted when  $V_{CC}$  is below the reset threshold ( $V_{TH}$ ), when  $\overline{MR}$  is driven low, or when WDI is not serviced within the watchdog timeout period ( $t_{WD}$ ). Reset remains asserted for the duration of the reset active timeout period ( $t_{RP}$ ) after  $V_{CC}$  rises above the reset threshold, after  $\overline{MR}$  transitions from low-to-high, or after the watchdog timer times out. Figure 16 illustrates the behavior of the reset outputs.

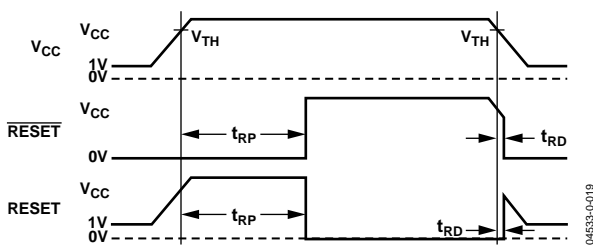

Figure 16. Reset Timing Diagram

### OPEN-DRAIN RESET OUTPUT

The ADM6320/ADM6321/ADM6322 have an active-low open-drain reset output. This output structure requires an external pull-up resistor to connect the reset output to a voltage rail no higher than 6 V. The resistor should comply with the microprocessor's logic low and logic high voltage level requirements while supplying input current and leakage paths on the  $\overline{RESET}$  line. A 10 k $\Omega$  resistor is adequate in most situations.

### MANUAL RESET INPUT

The ADM6316/ADM6317/ADM6319/ADM6320/ADM6322 feature a manual reset input ( $\overline{MR}$ ) which, when driven low, asserts the reset output. When  $\overline{MR}$  transitions from low to high, reset remains asserted for the duration of the reset active timeout period before deasserting. The  $\overline{MR}$  input has a 52 k $\Omega$  internal pull-up so that the input is always high when unconnected. An external push-button switch can be connected between  $\overline{MR}$  and ground so that the user can generate a reset. Debounce circuitry for this purpose is integrated on-chip. Noise immunity is provided on the  $\overline{MR}$  input, and fast, negative-going transients of up to 100 ns (typ) are ignored. A 0.1  $\mu$ F capacitor between  $\overline{MR}$  and ground provides additional noise immunity.

### WATCHDOG INPUT

The ADM6316/ADM6317/ADM6318/ADM6320/ADM6321 feature a watchdog timer, which monitors microprocessor activity. A timer circuit is cleared with every low-to-high or high-to-low logic transition on the watchdog input pin (WDI), which detects pulses as short as 50 ns. If the timer counts through the preset watchdog timeout period ( $t_{WD}$ ), reset is asserted. The microprocessor is required to toggle the WDI pin to avoid being reset. Failure of the microprocessor to toggle WDI within the timeout period, therefore, indicates a code execution error, and the reset pulse generated restarts the microprocessor in a known state.

As well as logic transitions on WDI, the watchdog timer is also cleared by a reset assertion due to an undervoltage condition on  $V_{CC}$  or due to  $\overline{MR}$  being pulled low. When reset is asserted, the watchdog timer is cleared and does not begin counting again until reset deasserts. The watchdog timer can be disabled by leaving WDI floating or by three-stating the WDI driver.

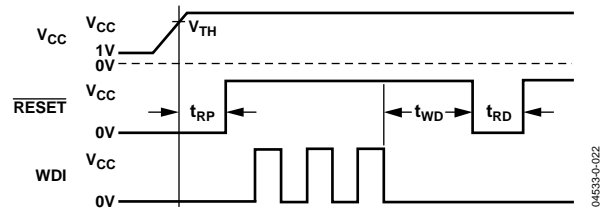

Figure 17. Watchdog Timing Diagram

## APPLICATION INFORMATION

### WATCHDOG INPUT CURRENT

In order to minimize watchdog input current (and minimize overall power consumption), leave WDI low for the majority of the watchdog timeout period. When driven high, WDI can draw as much as 160  $\mu$ A. Pulsing WDI low-high-low at a low duty cycle reduces the effect of the large input current. When WDI is unconnected, a window comparator disconnects the watchdog timer from the reset output circuitry so that reset is not asserted when the watchdog timer times out.

### NEGATIVE-GOING $V_{CC}$ TRANSIENTS

To avoid unnecessary resets caused by fast power supply transients, the ADM6316/ADM6317/ADM6318/ADM6319/ADM6320/ADM6321/ADM6322 are equipped with glitch rejection circuitry. The typical performance characteristic in Figure 13 plots  $V_{CC}$  transient duration vs. the transient magnitude. The curves show combinations of transient magnitude and duration for which a reset is not generated for 4.63 V and 2.93 V reset threshold parts. For example, with the 2.93 V threshold, a transient that goes 100 mV below the threshold and lasts 8  $\mu$ s typically does not cause a reset, but if the transient is any bigger in magnitude or duration, a reset is generated. An optional 0.1  $\mu$ F bypass capacitor mounted close to  $V_{CC}$  provides additional glitch rejection.

### ENSURING RESET VALID TO $V_{CC} = 0$ V

Both active-low and active-high reset outputs are guaranteed to be valid for  $V_{CC}$  as low as 1 V. However, by using an external resistor with push-pull configured reset outputs, valid outputs for  $V_{CC}$  as low as 0 V are possible. For an active-low reset output, a resistor connected between  $\overline{\text{RESET}}$  and ground pulls the output low when it is unable to sink current. For the active-high case, a resistor connected between RESET and  $V_{CC}$  pulls the output high when it is unable to source current. A large resistance such as 100 k $\Omega$  should be used so that it does not overload the reset output when  $V_{CC}$  is above 1 V.

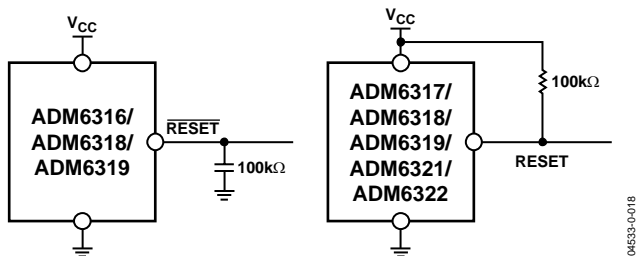

Figure 18. Ensuring Reset Valid to  $V_{CC} = 0$  V

### WATCHDOG SOFTWARE CONSIDERATIONS

In implementing the microprocessor's watchdog strobe code, quickly switching WDI low-high and then high-low (minimizing WDI high time) is desirable for current consumption reasons. However, a more effective way of using the watchdog function can be considered.

A low-high-low WDI pulse within a given subroutine prevents the watchdog timing out. However, if the subroutine becomes stuck in an infinite loop, the watchdog cannot detect this because the subroutine continues to toggle WDI. A more effective coding scheme for detecting this error involves using a slightly longer watchdog timeout. In the program that calls the subroutine, WDI is set high. The subroutine sets WDI low when it is called. If the program executes without error, WDI is toggled high and low with every loop of the program. If the subroutine enters an infinite loop, WDI is kept low, the watchdog times out, and the microprocessor is reset.

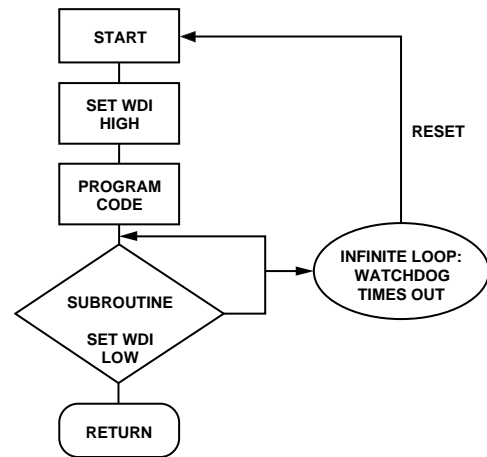

Figure 19. Watchdog Flow Diagram

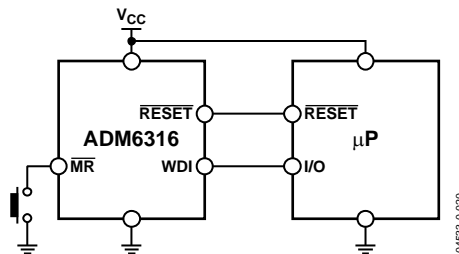

Figure 20. Typical Application Circuit

## OUTLINE DIMENSIONS

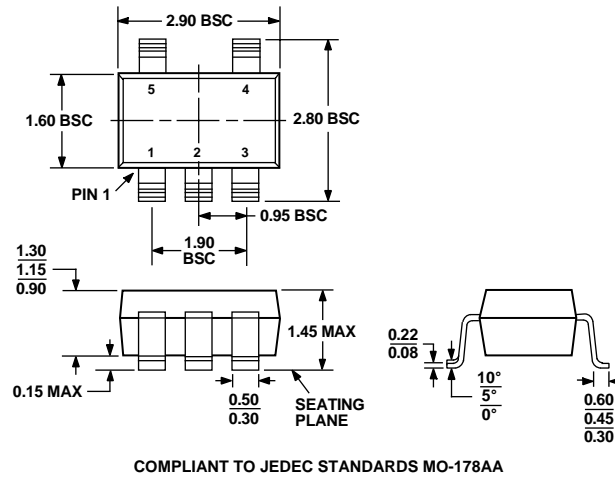

Figure 21. 5-Lead Small Outline Transistor Package

## ORDERING GUIDE

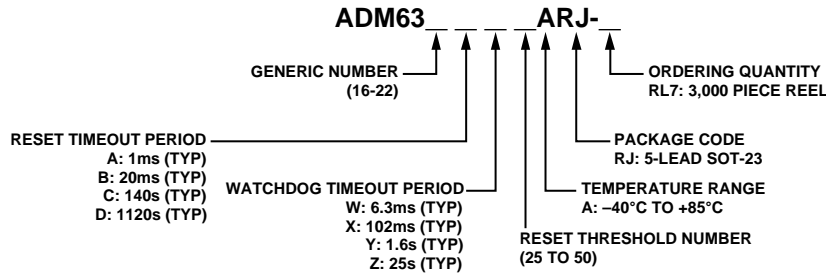

Figure 22. Ordering Code Structure

Model <sup>1,2</sup>	Temperature Range	Quantity <sup>3</sup>	Package Option	Branding
ADM6316 ___ ARJ-RL7	-40°C to +85°C	3k	SOT-23-5	N00
ADM6317 ___ ARJ-RL7	-40°C to +85°C	3k	SOT-23-5	N01
ADM6318 ___ ARJ-RL7	-40°C to +85°C	3k	SOT-23-5	N02
ADM6319 ___ ARJ-RL7	-40°C to +85°C	3k	SOT-23-5	N03
ADM6320 ___ ARJ-RL7	-40°C to +85°C	3k	SOT-23-5	N04
ADM6321 ___ ARJ-RL7	-40°C to +85°C	3k	SOT-23-5	N05
ADM6322 ___ ARJ-RL7	-40°C to +85°C	3k	SOT-23-5	N06

<sup>1</sup> Complete the ordering code by inserting reset timeout, watchdog timeout (ADM6316/ADM6317/ADM6318/ADM6320/ADM6321), and reset threshold suffixes from Table 5 to Table 7. No watchdog timeout for ADM6319/ADM6322.

<sup>2</sup> Contact Sales for the availability of nonstandard models. See Table 8 for a list of standard models.

<sup>3</sup> A minimum of 12k (4 reels) must be ordered.

This datasheet has been download from:

[www.datasheetcatalog.com](http://www.datasheetcatalog.com)

Datasheets for electronics components.