



## ECL/TTL/ECL Translator and High-Speed Bus Driver

### Features

- BiCMOS for optimum speed/power
- High speed (max.)
  - 3.0 ns  $t_{PD}$  TTL-to-ECL
  - 4 ns  $t_{PD}$  ECL-to-TTL
- Low skew  $< \pm 1$  ns
- Can operate on single +5V supply
- Full-duplex ECL/TTL data transmission
- Internal 2 k $\Omega$  ECL pull-down resistors on each ECL output
- 80-pin PQFP package
- 84-pin PLCC package
- $V_{BB}$  ECL reference voltage output
- Single- or dual-supply operation
- Capable of greater than 2001V ESD
- ECL cable/twisted pair driver

### Functional Description

The CY101E383 is a new-generation TTL-to-ECL and ECL-to-TTL logic level translator designed for high-perfor-

mance systems. The device contains ten independent TTL-to-ECL and ten independent ECL-to-TTL translators for high-speed full-duplex data transmission, mixed logic, and bus applications. The CY101E383 is especially suited to drive ECL backplanes between TTL boards. The CY101E383 is implemented with differential ECL I/O to provide balanced low noise operation over controlled impedance buses between TTL and/or ECL subsystems. In addition, the device has internal output 2 k $\Omega$  pull-down resistors tied to VEE to decrease the number of external components. For system testing purposes or for driving light loads, the 2 k $\Omega$  is used as the only termination thereby eliminating up to 20 external resistors. The part meets standard 100K logic levels with the internal pull-down while driving 50 $\Omega$  to -2V.

The device is designed with ample ground pins to reduce bounce, and has separate ECL and TTL power/ground pins to reduce noise coupling between logic families. The parts can operate in single- or dual-supply configurations while maintaining absolute and 100K level swings. The translators are offered in a standard 100K ECL-compatible version with -5.2V or -4.5V power supply. The TTL I/O is fully TTL compatible. The CY101E383 is packaged in 84-pin surface-mountable PLCCs and CLCCs. To save board space, an 80-pin PQFP package with 25-mil-lead pitch is available.

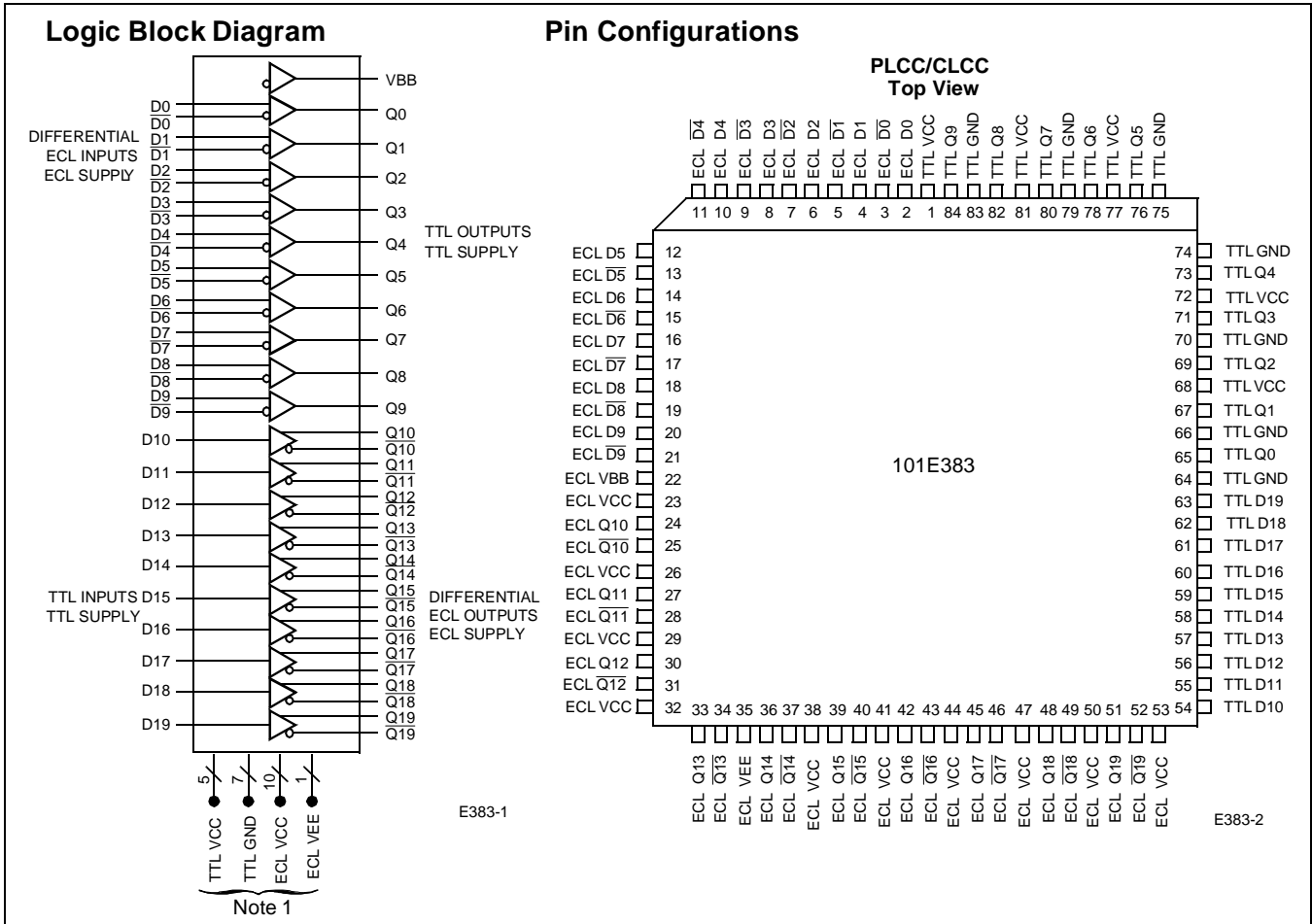

**Note:**

1. The PQFP package has one less each TTL V<sub>CC</sub> and TTL GND pin and two less ECL V<sub>CC</sub> pins.

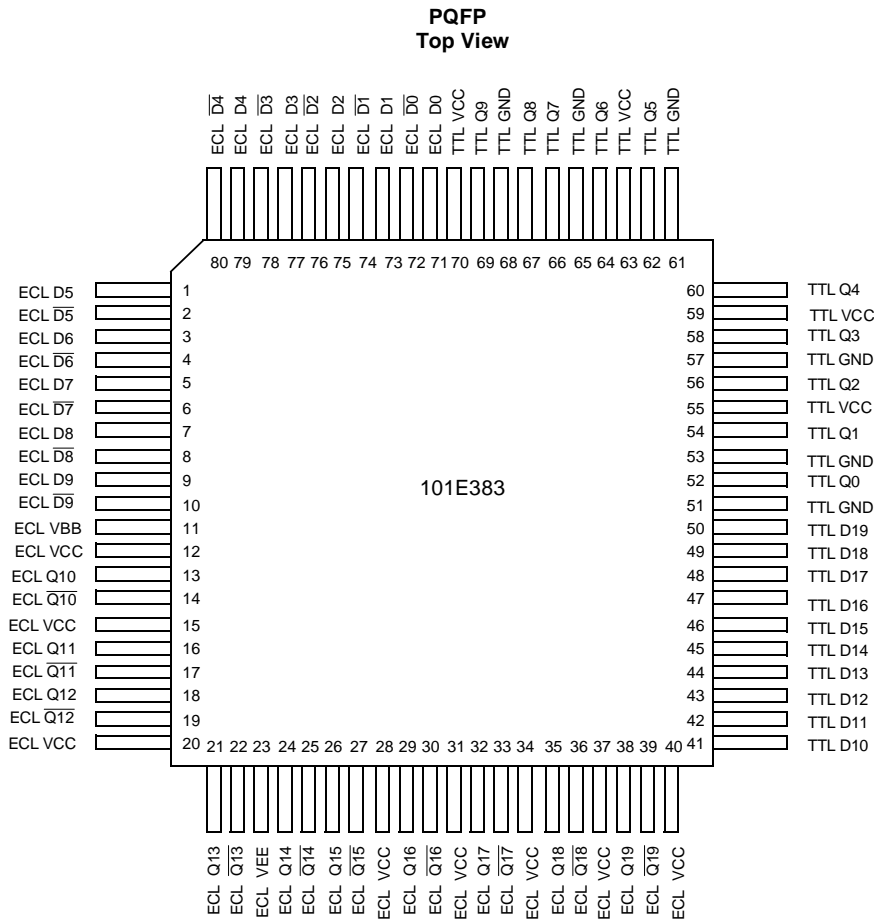
**Pin Configurations** (continued)

E383-3

**Selection Guide**

	<b>101E383-3</b>
Maximum Propagation Delay Time (ns) (TTL to ECL)	3
Maximum Propagation Delay Time (ns) (ECL to TTL)	4
Maximum Operating Current (mA) Sum of $I_{EE}$ and $I_{CC}$	300

**Maximum Ratings**

(Above which the useful life may be impaired. For user guidelines, not tested.)

Storage Temperature .....  $-65^{\circ}\text{C}$  to  $+150^{\circ}\text{C}$   
 Ambient Temperature with Power Applied.....  $-55^{\circ}\text{C}$  to  $+125^{\circ}\text{C}$   
 TTL Supply Voltage to Ground Potential .....  $-0.5\text{V}$  to  $+7.0\text{V}$   
 TTL DC Input Voltage .....  $-3.0\text{V}$  to  $+7.0\text{V}$   
 ECL Supply Voltage  $V_{EE}$  to ECL  $V_{CC}$  .....  $-7.0\text{V}$  to  $+0.5\text{V}$   
 ECL Input Voltage .....  $V_{EE}$  to  $+0.5\text{V}$

ECL Output Current .....  $-50\text{ mA}$   
 Static Discharge Voltage .....  $>2001\text{V}$   
 (per MIL-STD-883, Method 3015)  
 Latch-Up Current.....  $>200\text{ mA}$

**Operating Range**

Range	I/O	Version	Ambient Temperature	ECL $V_{EE}$	TTL $V_{CC}$
Commercial	100K	101E	$0^{\circ}\text{C}$ to $+85^{\circ}\text{C}$	$-4.2\text{V}$ to $-5.46\text{V}$	$5\text{V} \pm 5\%$

**ECL Electrical Characteristics** Over the Operating Range<sup>[2]</sup>

Parameter	Description	Test Conditions	Temperature <sup>[3]</sup>	101E383		Unit
				Min.	Max.	
V <sub>OH</sub>	Output HIGH Voltage	101E, R <sub>L</sub> = 50Ω to -2V V <sub>IN</sub> = V <sub>IH</sub> Min. or V <sub>IL</sub> Max.	T <sub>A</sub> = 0°C to 85°C	-1065	-700	mV
V <sub>OL</sub>	Output LOW Voltage	101E, R <sub>L</sub> = 50Ω to -2V V <sub>IN</sub> = V <sub>IH</sub> Min. or V <sub>IL</sub> Max.	T <sub>A</sub> = 0°C to 85°C	-1900	-1600	mV
V <sub>IH</sub>	Input HIGH Voltage	101E	T <sub>A</sub> = 0°C to 85°C	-1165	-700	mV
V <sub>IL</sub>	Input LOW Voltage	101E	T <sub>A</sub> = 0°C to 85°C	-1900	-1475	mV
V <sub>BB</sub>	Output Reference Voltage	101E <sup>[4]</sup>	T <sub>A</sub> = 0°C to 85°C	-1.5	-1.15	V
V <sub>CM</sub> <sup>[5]</sup>	Common Mode Voltage	±V <sub>CM</sub> with respect to V <sub>BB</sub>			1.0	V
V <sub>DIFF</sub>	Input Voltage Differential	Required for Full Output Swing		150		mV
I <sub>IH</sub>	Input HIGH Current	V <sub>IN</sub> = V <sub>IH</sub> Max.			220	μA
I <sub>IL</sub>	Input LOW Current	V <sub>IN</sub> = V <sub>IL</sub> Min.		-0.5	170	μA
R <sub>PD</sub>	Pull-Down Resistor	Connected from All ECL Outputs to V <sub>EE</sub>	T <sub>A</sub> = 0°C to 85°C	1.6	3.0	kΩ
I <sub>EE</sub>	Supply Current (All inputs and outputs open)				-180	mA

**TTL Electrical Characteristics** Over the Operating Range<sup>[2]</sup>

Parameter	Description	Test Conditions	101E383		Unit
			Min.	Max.	
V <sub>OH</sub>	Output HIGH Voltage	V <sub>CC</sub> = Min., I <sub>OH</sub> = -3.2 mA	2.4		V
V <sub>OL</sub>	Output LOW Voltage	V <sub>CC</sub> = Max., I <sub>OL</sub> = 16.0 mA		0.5	V
V <sub>IH</sub>	Input HIGH Voltage <sup>[6]</sup>		2.0		V
V <sub>IL</sub>	Input LOW Voltage <sup>[5]</sup>			0.8	V
V <sub>CD</sub>	Input Clamp Diode Voltage	I <sub>IN</sub> = -10 mA	-1.5		V
I <sub>OS</sub> <sup>[7]</sup>	Output Short-Circuit Current	V <sub>CC</sub> = Max., V <sub>OUT</sub> = 0.5V <sup>[8]</sup>	-180	-40	mA
I <sub>IX</sub>	Input Load Current <sup>[9]</sup>	GND ≤ V <sub>I</sub> ≤ V <sub>CC</sub>	-250	+20	μA
I <sub>CC</sub>	V <sub>CC</sub> Operating Supply Current	V <sub>CC</sub> = Max., I <sub>OUT</sub> = 0 mA, f = f max.		120	mA

**Capacitance<sup>[7]</sup>**

Parameter	Description	Max.	Unit
C <sub>IN</sub> <sup>[7]</sup>	Input Capacitance	4	pF
C <sub>OUT</sub> <sup>[7]</sup>	Output Capacitance	5	pF

**Notes:**

- See AC Test Load and Waveform for test conditions.
- Commercial grade is specified as ambient temperature with transverse air flow greater than 500 linear feet per minute.
- Max. I<sub>BB</sub> = -1 mA.
- The internal gain of the CY101E383 guarantees that the output voltage will not change for common mode signals to ±1V. Therefore, input C<sub>MRR</sub> is infinite within the common mode range.
- These are absolute values with respect to device ground.
- Characterized initially and after any design or process changes that may affect these parameters.
- Not more than one output should be tested at a time. Duration of the short should not be more than one second.
- I/O pin leakage is the worst case of I<sub>IX</sub> (where X = H or L).

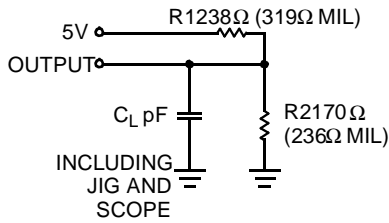
**TTL AC Test Load and Waveform<sup>[10]</sup>**

E383-5

Equivalent to: THÉVENIN EQUIVALENT (Commercial)

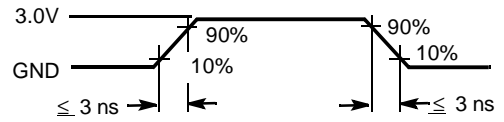
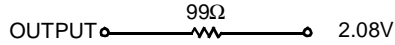

E383-4

THÉVENIN EQUIVALENT (Military)

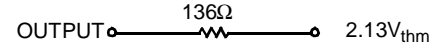
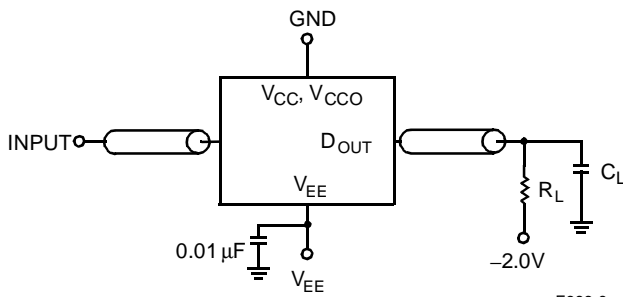
**ECL AC Test Load and Waveform<sup>[11, 12, 13, 14, 15]</sup>**

E383-6

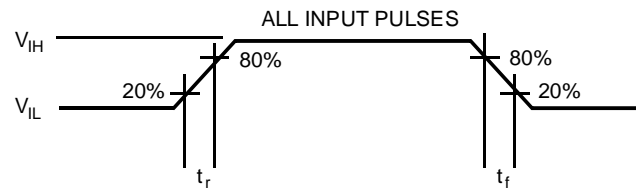

E383-7

**ECL-to-TTL Switching Characteristics Over the Operating Range**

Parameter	Description	Test Conditions	101E383-3		Unit
			Min.	Max.	
$t_{PLH}$	Propagation Delay Time	$D_n, \bar{D}_n$ to $Q_n$	1	4	ns
$t_{PHL}$	Propagation Delay Time	$D_n, \bar{D}_n$ to $Q_n$	1	4	ns

**TTL-to-ECL Switching Characteristics Over the Operating Range**

Parameter	Description	Test Conditions	101E383-3		Unit
			Min.	Max.	
$t_{PLH}$	Propagation Delay Time	$D_n$ to $Q_n, \bar{Q}_n$	1	3	ns
$t_{PHL}$	Propagation Delay Time	$D_n$ to $Q_n, \bar{Q}_n$	1	3	ns
$t_R^{[7]}$	Output Rise Time	20% to 80%	0.35	1.7	ns
$t_F^{[7]}$	Output Fall Time	20% to 80%	0.35	1.7	ns

**Skew Time Switching Characteristics<sup>[7]</sup> (Same test conditions as TTL-to-ECL and ECL-to-TTL Electrical Characteristics)**

Symbol	Characteristic	Test Conditions	Min.	Max.	Unit
$t_{SKT}^{[7]}$	Data Skew Time ECL-to-TTL	$TTLQ_n$ to $TTLQ_{n+m}$		1	ns
$t_{SKE}^{[7]}$	Data Skew Time TTL-to-ECL	$ECLQ_n, \bar{Q}_n$ to $ECLQ_{n+m}, \bar{Q}_{n+m}$		1	ns

**Skew Time Switching Characteristics<sup>[7]</sup>** (Same test conditions as TTL-to-ECL and ECL-to-TTL Electrical Characteristics)

Symbol	Characteristic	Test Conditions	Min.	Max.	Unit
--------	----------------	-----------------	------	------	------

10. TTL test conditions assume signal transition times of 3 ns or less, timing reference levels of 1.5 V, input pulse levels of 0 to 3.0V, and output loading of the specified  $I_{OL}/I_{OH}$ , and  $C_L = 10$  pF.
11.  $V_{IL} = -1.7V$ ,  $V_{IH} = -0.9V$ .
12. ECL  $R_L = 50\Omega$ ,  $C_L < 5$  pF (includes fixture and stray capacitance).
13. All coaxial cables should be  $50\Omega$  with equal lengths. The delay of the coaxial cables should be "nulled" out of the measurement.
14.  $t_r = t_f = 0.7$  ns
15. All timing measurements are made from the 50% point of all waveforms.

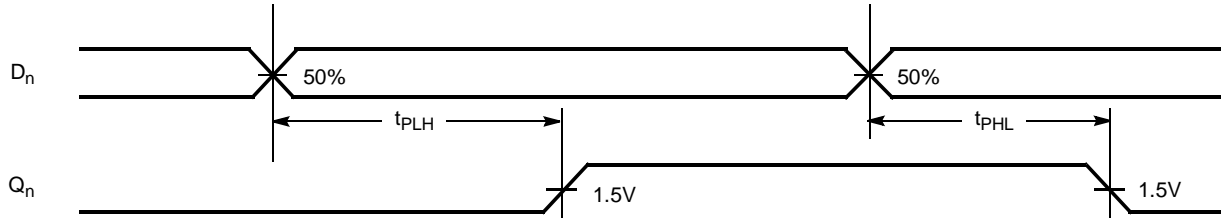
**Switching Waveforms**
**ECL-to-TTL Timing**

E383-8

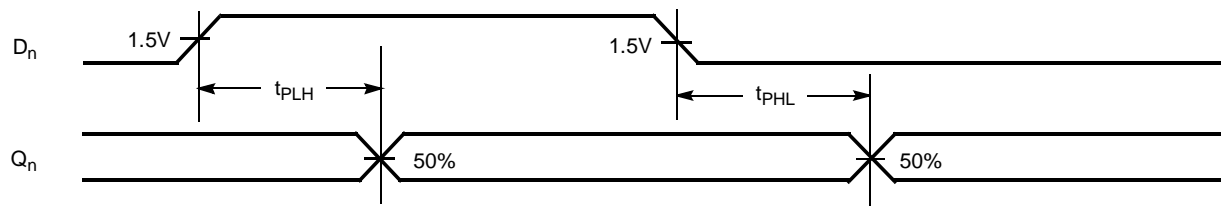
**TTL-to-ECL Timing**

E383-9

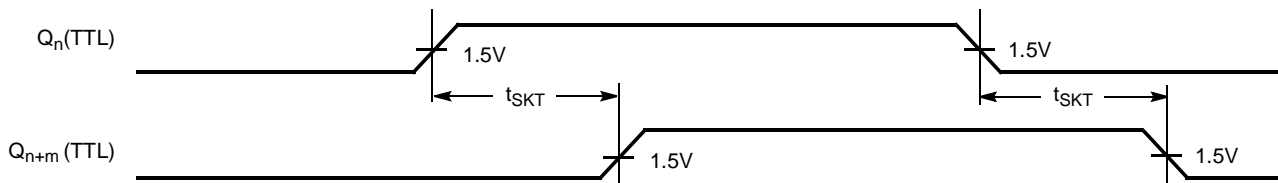
**Skew Test ( $t_{SKT}$ )  
TTL $_{An}$ -to-TTL $_{Qn+m}$** 

E383-10

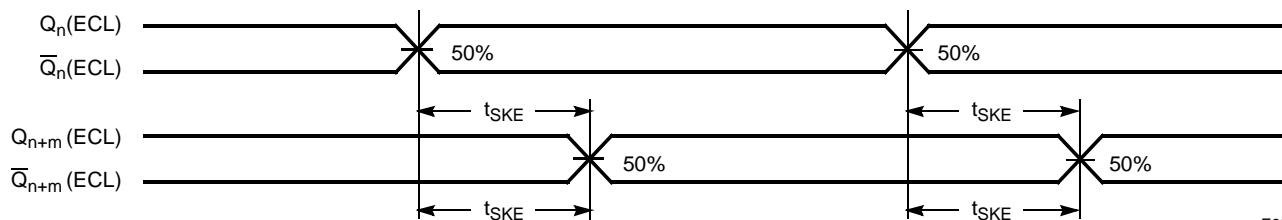
**Skew Test ( $t_{SKE}$ )  
ECL $_{Qn}$ ,  $\bar{Q}_n$ -to-ECL $_{Qn+m}$ ,  $\bar{Q}_{n+m}$** 

E383-11

**ECL-to-TTL Truth Table**

Inputs		Outputs
ECL $D_n$	ECL $\bar{D}_n$	TTL $Q_n$
Open <sup>[16]</sup>	Open <sup>[16]</sup>	L
L	H	L
H	L	H

**TTL-to-ECL Truth Table**

Inputs	Outputs	
TTL $D_n$	ECL $Q_n$	ECL $\bar{Q}_n$
L	L	H
H	H	L

**Nominal Voltages**

The CY101E383 can be used in dual  $\pm 5V$  or single +5V supply systems. The supply pins should be connected as shown in *Tables 1* and *2*. This connection technique involves shifting up all ECL supply pins by 5V. When operating in single-supply systems, the ECL termination voltage level must also be shifted up by adding 5V. For example, if the termination is 50 ohms to  $-2V$  in a dual-supply system, the single +5V system should have 50 ohms to +3V. If the termination is a Thévenin type, then the resistor tied to ground is now at +5V and the

resistor tied to  $-5V$  is now at ground potential. Consideration should be given to the power supply so that adequate bypassing is made to isolate the ECL output switching noise from the supply. Having separate TTL and ECL +5V supply lines will help to reduce the noise.

**Table 1. CY101E383 Nominal Voltages Applied in 100K System**

Supply Pin	Single-Supply System	Dual-Supply System
TTL $V_{CC}$	+5.0V	+5.0V
TTL GND	0.0V	0.0V
ECL $V_{CC}$	+5.0V	0.0V
ECL $V_{EE}$	0.0V	-4.5V

**Table 2. CY101E383 Nominal Voltages Applied in 101K System**

Supply Pin	Single-Supply System	Dual-Supply System
TTL $V_{CC}$	+5.0V	+5.0V
TTL GND	0.0V	0.0V
ECL $V_{CC}$	+5.0V	0.0V
ECL $V_{EE}$	0.0V	-5.2V

**Ordering Information**

Speed (ns)	Ordering Code	Package Name	Package Type	Operating Range
3	CY101E383-3JC	J83	84-Lead Plastic Leaded Chip Carrier	Commercial
	CY101E383-3NC	N80	80-Lead Plastic Quad Flatpack	

**Note:**

16. The ECL inputs will pull to a known logic level if left open.

Document #: 38-A-00023-I

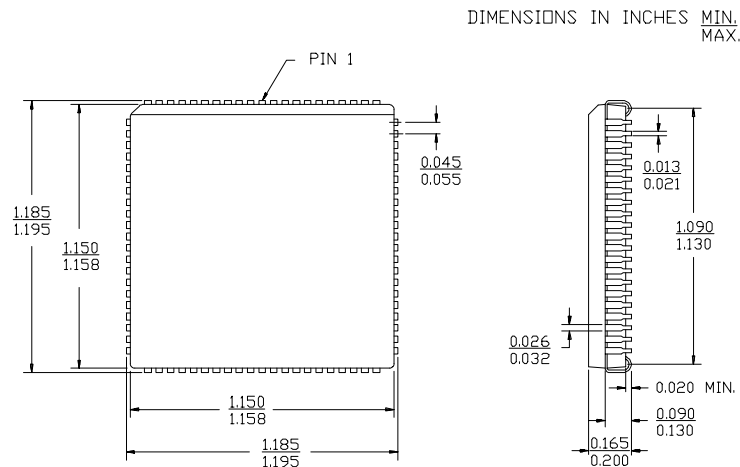
**Package Diagrams**
**84-Lead Plastic Leaded Chip Carrier J83**



Package Diagrams (continued)

80-Lead Plastic Quad Flatpack N80

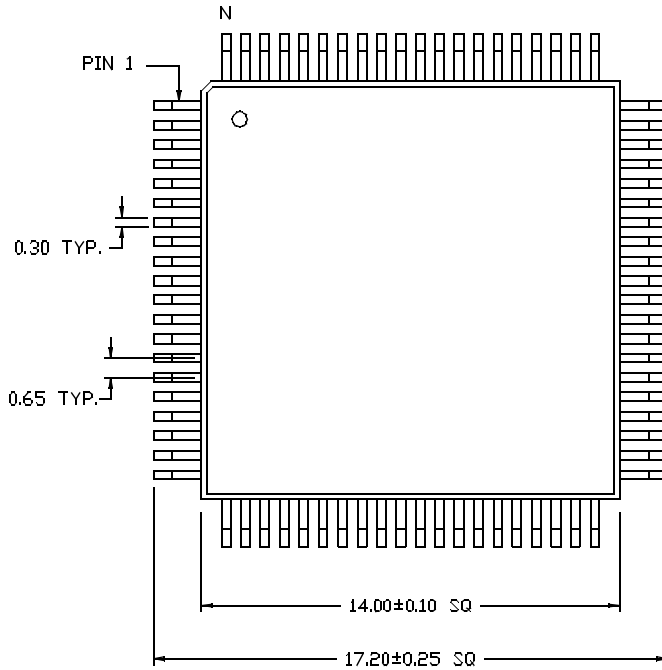

DIMENSIONS ARE IN MILLIMETERS  
LEAD COPLANARITY 0.102 MAX.

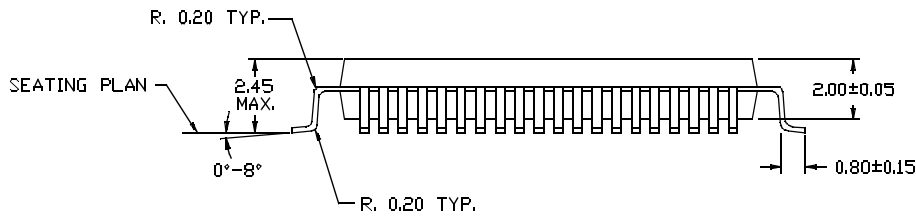

Package Diagrams (continued)

84-Pin Ceramic Leaded Chip Carrier Y84

