

GP2S28

Long Focal Distance, Case Type Photointerrupter

■ Features

1. Long focal distance type
(Detecting range: 6mm)
2. With pins for protection of wrong insertion
3. Snap-in mounting type

■ Applications

1. CD players
2. Facsimiles
3. Printers

■ Outline Dimensions

(Unit : mm)

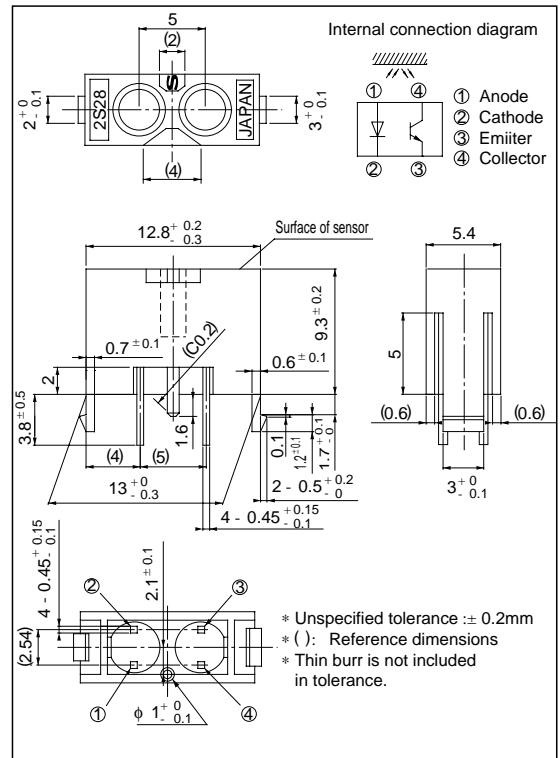

■ Absolute Maximum Ratings

(Ta = 25°C)

Parameter		Symbol	Rating	Unit
Input	Forward current	I _F	60	mA
	*1 Peak forward current	I _{FM}	1	A
	Reverse voltage	V _R	6	V
	Power dissipation	P	150	mW
Output	Collector-emitter voltage	V _{CEO}	35	V
	Emitter-collector voltage	V _{ECO}	6	V
	Collector current	I _C	20	mA
	Collector power dissipation	P _C	50	mW
Operating temperature		T _{opr}	- 25 to + 85	°C
Storage temperature		T _{stg}	- 40 to + 85	°C
*2 Soldering temperature		T _{sol}	260	°C

*1 Pulse width $\leq 100\ \mu\text{s}$, Duty ratio: 0.01

*2 For 5 seconds

■ Electro-optical Characteristics

(Ta = 25°C)

Parameter		Symbol	Condition	MIN.	TYP.	MAX.	Unit	
Input	Forward voltage	V_F	$I_F = 20\text{mA}$	-	1.3	1.5	V	
	Peak forward voltage	V_{FM}	$I_F = 0.5\text{A}$	-	2.2	3.5	V	
	Reverse current	I_R	$V_R = 3\text{V}$	-	-	10	μA	
Output	Collector current	I_{CEO}	$V_{CE} = 20\text{V}$	-	1	100	nA	
Transfer characteristics	Collector current	I_C	$V_{CE} = 5\text{V}, I_F = 20\text{mA}, *3$	0.04	-	0.9	mA	
	Collector-emitter saturation voltage	$V_{CE(sat)}$	$I_F = 40\text{mA}, I_C = 0.04\text{mA}$	-	-	0.4	V	
	Response time	Rise time	t_r	$V_{CE} = 2\text{V}, I_C = 0.1\text{mA}$	-	-	20	μs
		Fall time	t_f	$R_L = 100\Omega$	-	-	30	μs

*3 The condition and arrangement of reflective object is shown in the following figure.

Test Circuit for Response Time

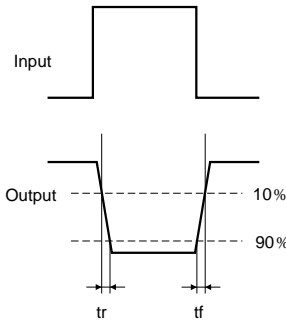
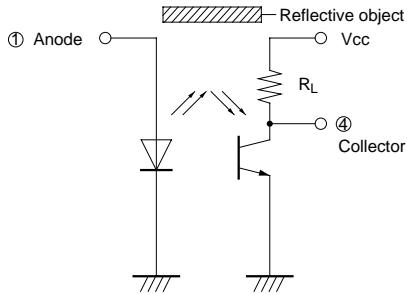

Test Arrangement of Collector Current

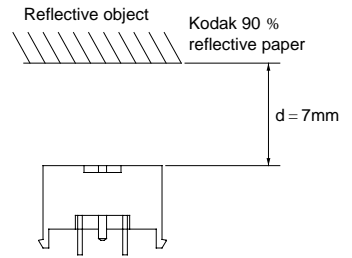

Fig. 1 Forward Current vs. Ambient Temperature

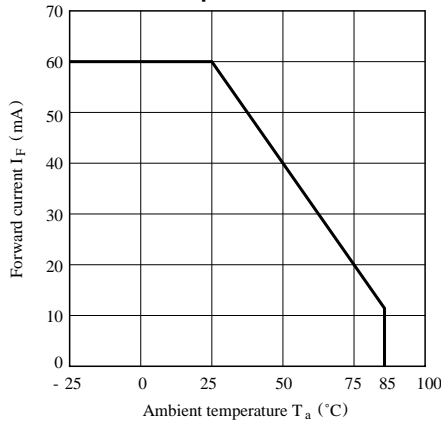

Fig. 2 Collector Power Dissipation vs. Ambient Temperature

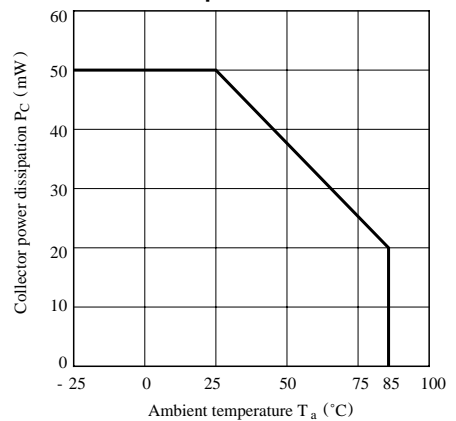

Fig. 3 Peak Forward Current vs. Duty Ratio

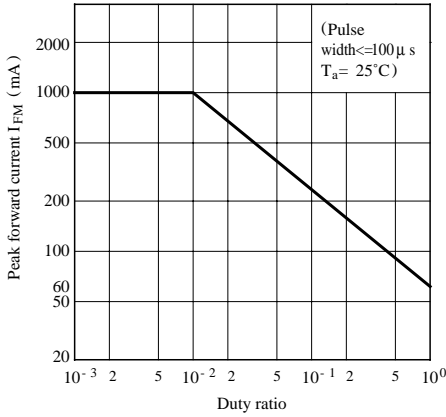

Fig. 4 Forward Current vs. Forward Voltage

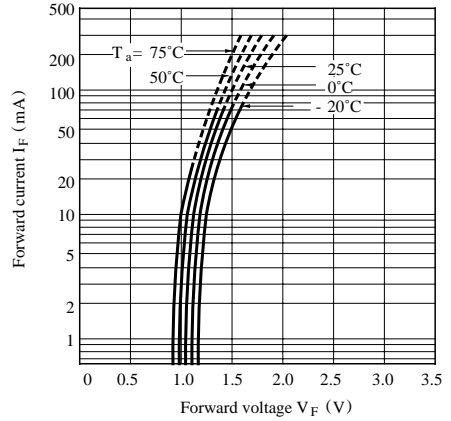

Fig. 5 Collector-current vs. Forward Current

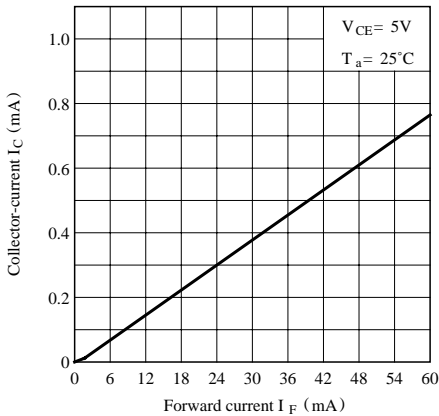

Fig. 6 Collector Current vs. Collector-emitter Voltage

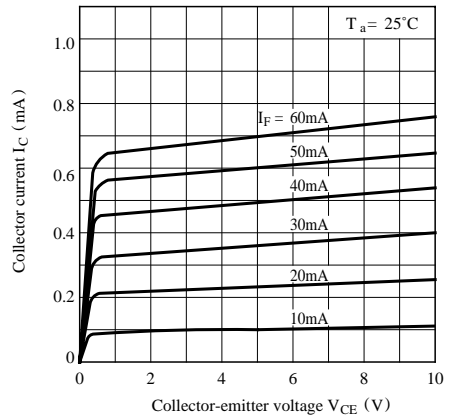

Fig. 7 Collector Current vs. Ambient Temperature

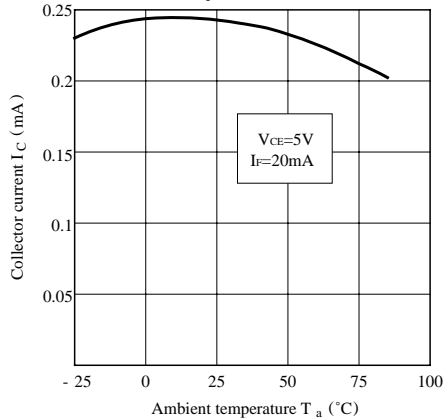

Fig. 8 Collector Dark Current vs. Ambient Temperature

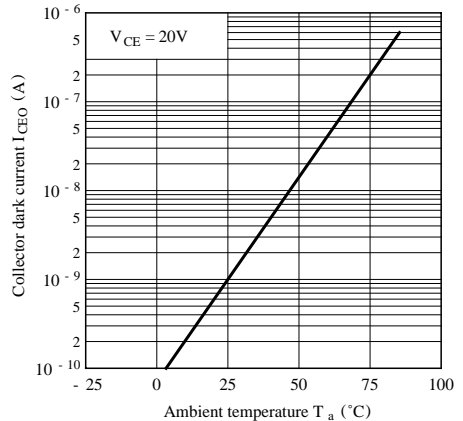
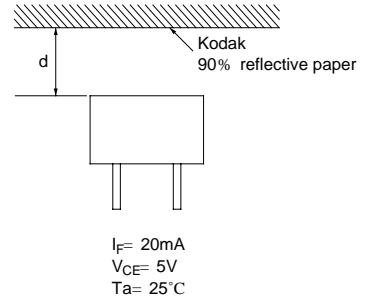
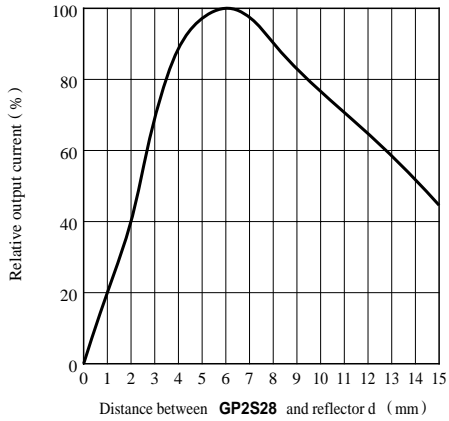

Fig. 9 Relative Output Current vs. Detecting Distance



- Please refer to the chapter “Precautions for Use”.