

The RF MOSFET Line
Power Field Effect Transistor
N-Channel Enhancement-Mode MOSFET

Designed primarily for wideband large-signal output and driver from 30–500 MHz.

- Guaranteed 28 Volt, 500 MHz Performance
Output Power = 4.0 Watts
Gain = 16 dB (Min)
Efficiency = 55% (Typ)
- Excellent Thermal Stability, Ideally Suited for Class A Operation
- Facilitates Manual Gain Control, ALC and Modulation Techniques
- 100% Tested for Load Mismatch at All Phase Angles with 30:1 VSWR
- Low C_{RSS} – 0.8 pF Typical at $V_{DS} = 28$ Volts

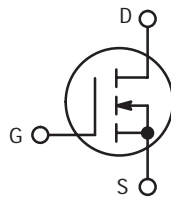

MRF160

To 500 MHz, 4 W, 28 V
MOSFET BROADBAND
RF POWER FET

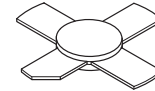

CASE 249-06, STYLE 3

MAXIMUM RATINGS ($T_J = 25^\circ\text{C}$ unless otherwise noted)

Rating	Symbol	Value	Unit
Drain-Gate Voltage	V_{DSS}	65	Vdc
Drain-Gate Voltage ($R_{GS} = 1.0\text{ M}\Omega$)	V_{DGR}	65	Vdc
Gate-Source Voltage	V_{GS}	± 20	Vdc
Drain Current-Continuous	I_D	1.0	ADC
Total Device Dissipation @ $T_C = 25^\circ\text{C}$ Derate Above 25°C	P_D	24 0.14	Watts W/ $^\circ\text{C}$
Storage Temperature Range	T_{stg}	- 65 to +150	$^\circ\text{C}$
Operating Junction Temperature	T_J	200	$^\circ\text{C}$

THERMAL CHARACTERISTICS

Thermal Resistance — Junction to Case	$R_{\theta JC}$	7.2	$^\circ\text{C/W}$
---------------------------------------	-----------------	-----	--------------------

NOTE — **CAUTION** — MOS devices are susceptible to damage from electrostatic charge. Reasonable precautions in handling and packaging MOS devices should be observed.

ELECTRICAL CHARACTERISTICS ($T_C = 25^\circ\text{C}$ unless otherwise noted)

Characteristic	Symbol	Min	Typ	Max	Unit
----------------	--------	-----	-----	-----	------

OFF CHARACTERISTICS

Drain–Source Breakdown Voltage ($V_{DS} = 0 \text{ Vdc}$, $V_{GS} = 0 \text{ Vdc}$, $I_D = 1.0 \text{ mA}$)	$V_{(BR)DSS}$	65	—	—	Vdc
Zero Gate Voltage Drain Current ($V_{DS} = 28 \text{ Vdc}$, $V_{GS} = 0 \text{ V}$)	I_{DSS}	—	—	0.5	mA
Gate–Source Leakage Current ($V_{GS} = 20 \text{ Vdc}$, $V_{DS} = 0 \text{ Vdc}$)	I_{GSS}	—	—	1.0	μA

ON CHARACTERISTICS

Gate Threshold Voltage ($V_{DS} = 10 \text{ Vdc}$, $I_D = 10 \text{ mA}$)	$V_{GS(th)}$	1.5	3.0	4.5	Vdc
Drain Source On–Voltage ($V_{DS(on)}$, $V_{GS} = 10 \text{ Vdc}$, $I_D = 500 \text{ mA}$)	$V_{DS(on)}$	—	3.8	—	Vdc
Forward Transconductance ($V_{DS} = 10 \text{ Vdc}$, $I_D = 250 \text{ mA}$)	g_{fs}	150	220	—	mS

DYNAMIC CHARACTERISTICS

Input Capacitance ($V_{DS} = 28 \text{ Vdc}$, $V_{GS} = 0 \text{ V}$, $f = 1.0 \text{ MHz}$)	C_{iss}	—	6.0	—	pF
Output Capacitance ($V_{DS} = 28 \text{ V}$, $V_{GS} = 0 \text{ Vdc}$, $f = 1.0 \text{ MHz}$)	C_{oss}	—	6.5	—	pF
Reverse Transfer Capacitance ($V_{DS} = 28 \text{ Vdc}$, $V_{GS} = 0 \text{ Vdc}$, $f = 1.0 \text{ MHz}$)	C_{rss}	—	0.8	—	pF

FUNCTIONAL CHARACTERISTICS

Common Source Power Gain ($V_{DD} = 28 \text{ Vdc}$, $P_{out} = 4.0 \text{ W}$, $f = 500 \text{ MHz}$, $I_{DQ} = 50 \text{ mA}$)	G_{ps}	16	18	—	dB
Drain Efficiency ($V_{DD} = 28 \text{ Vdc}$, $P_{out} = 4.0 \text{ W}$, $f = 500 \text{ MHz}$, $I_{DQ} = 50 \text{ mA}$)	η	50	55	—	%
Electrical Ruggedness ($V_{DD} = 28 \text{ Vdc}$, $P_{out} = 4.0 \text{ W}$, $f = 500 \text{ MHz}$, $I_{DQ} = 50 \text{ mA}$) Load VSWR = 30:1 at All Phase Angles at Frequency of Test	ψ	No Degradation in Output Power			
Series Equivalent Input Impedance ($V_{DD} = 28 \text{ Vdc}$, $P_{out} = 4.0 \text{ W}$, $f = 500 \text{ MHz}$, $I_{DQ} = 50 \text{ mA}$)	Z_{in}	—	$6.8 - j21$	—	Ohms
Series Equivalent Output Impedance ($V_{DD} = 28 \text{ Vdc}$, $P_{out} = 4.0 \text{ W}$, $f = 500 \text{ MHz}$, $I_{DQ} = 50 \text{ mA}$)	Z_{out}	—	$21 - j28$	—	Ohms

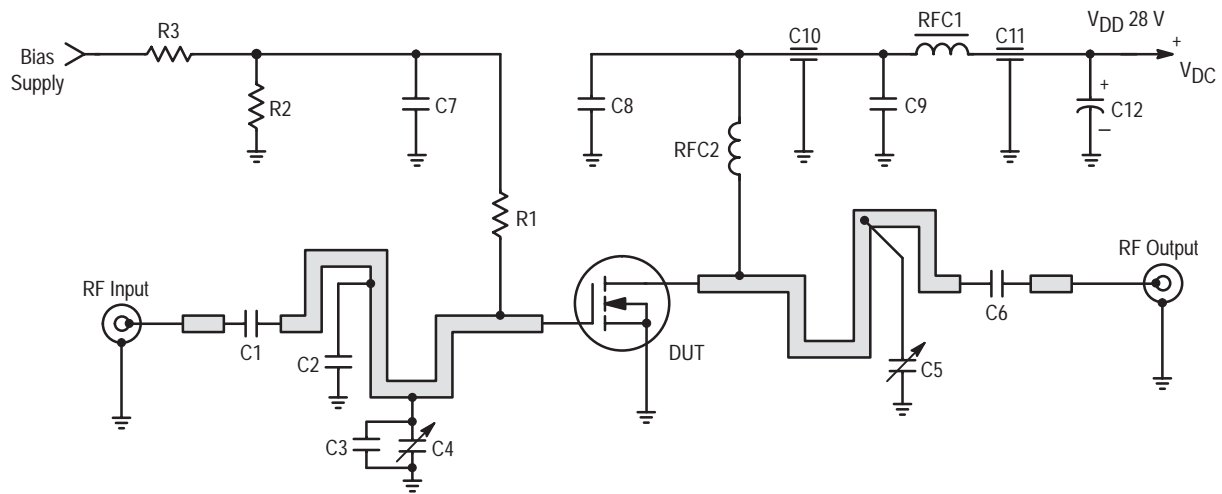

- C1, C6 240 pF, 100 mil Chip Capacitors
- C2 15 pF, 100 mil ATC Chip Capacitor
- C4, C5 1 – 10 pF, Johanson Trimmer Capacitors
- C3 24 pF, 100 mil ATC Chip Capacitor
- C7, C9 0.1 μ F, 100 mil Chip Capacitors
- C8 220 pF, 100 mil ATC Chip Capacitor
- C10, C11 680 pF, Feed Through Capacitors
- C12 50 μ F, 50 V Electrolytic Capacitor

- R1 200 Ω , 1/2 Watt
- R2 10 k Ω , 1/2 Watt
- R3 1 k Ω , 1/2 Watt
- RFC1 Ferroxcube VK200–19/4B
- RFC2 8 Turns, #20 AWG, Enameled, ID 110 mils

Board Material — 0.062", Teflon® Fiberglass, 1 oz.,
Copper clad both sides, $\epsilon_r = 2.55$

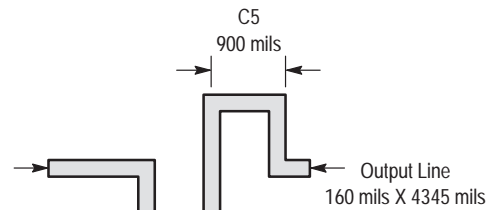
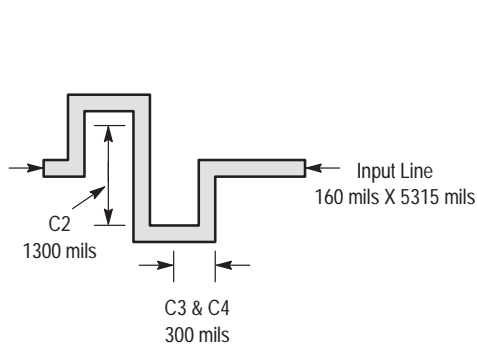

NOTE: Due to variation in Chip Capacitor values and board material, these are approximate positions.

Figure 1. MRF160 500 MHz Test Circuit

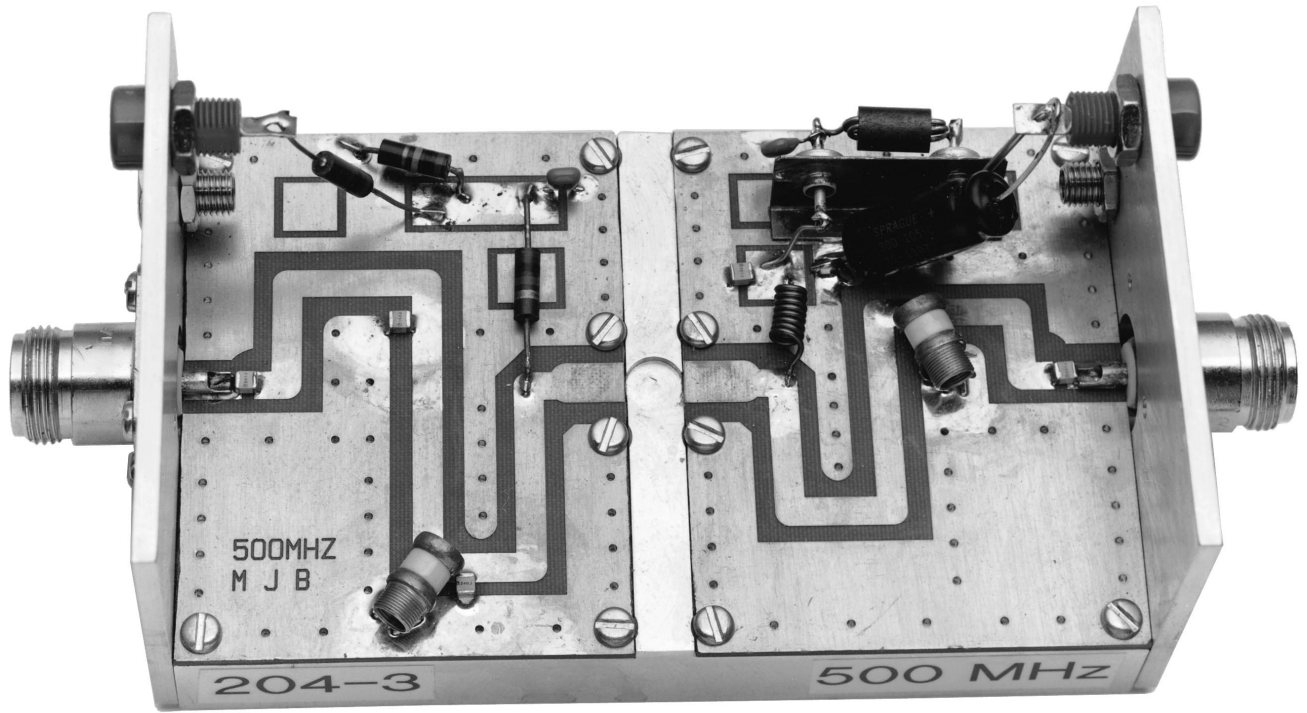

Figure 2. MRF160 Broadband Test Fixture

TYPICAL CHARACTERISTICS

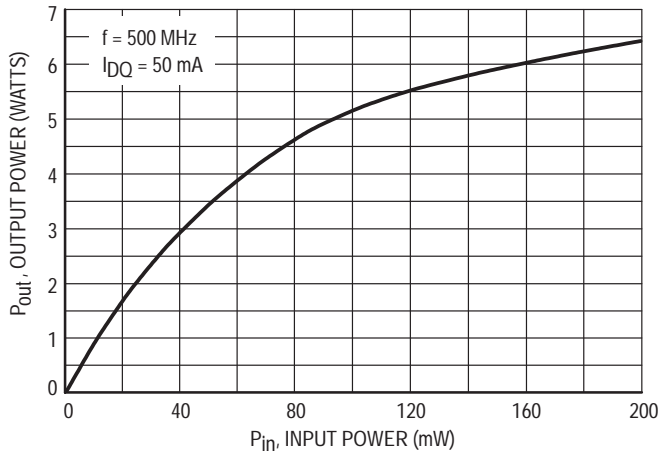

Figure 3. Output Power versus Input Power

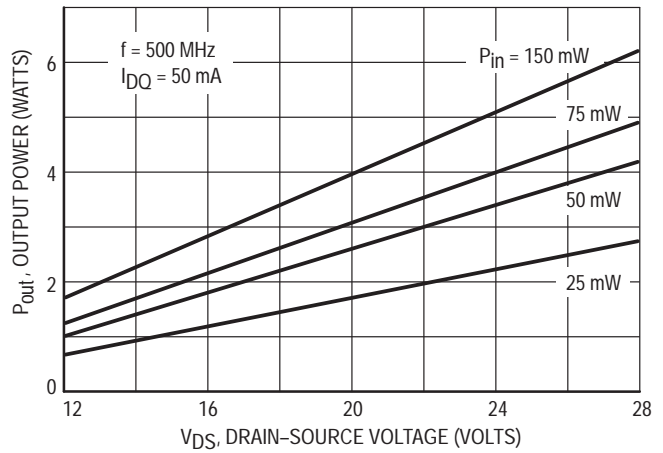

Figure 4. Output Power versus Voltage

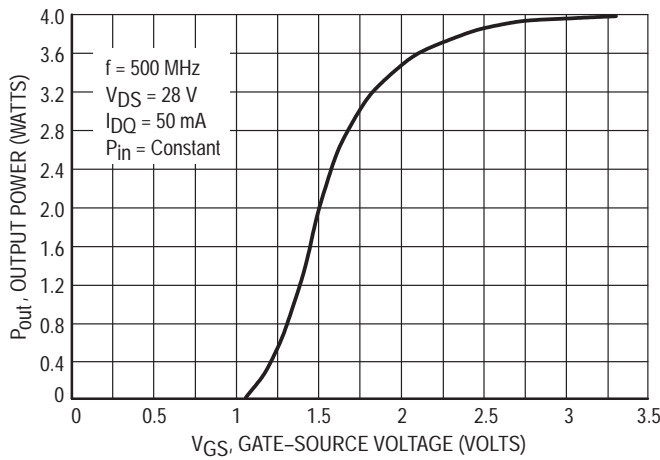

Figure 5. Output Power versus Gate Voltage

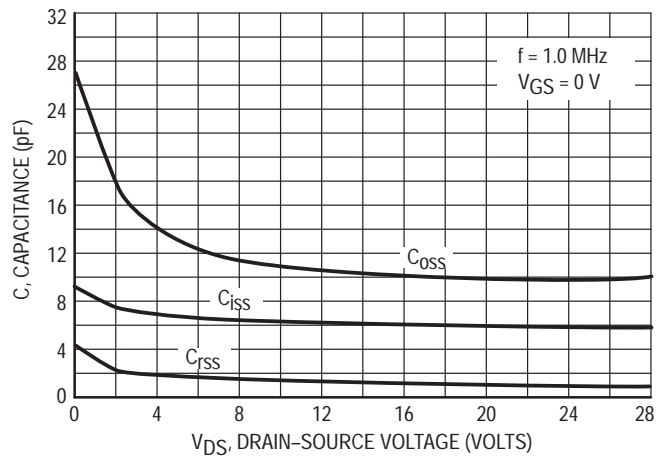

Figure 6. Capacitance versus Drain-Source Voltage

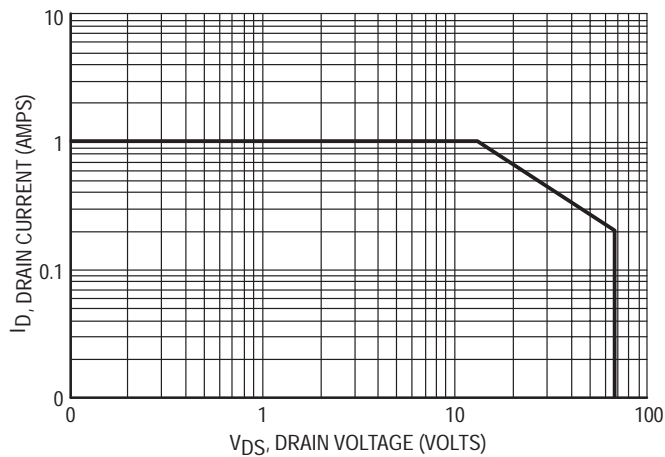

Figure 7. DC Safe Operating Area

Table 1. Common Source S-Parameters ($V_{DS} = 12.5\text{ V}$, $I_D = 120\text{ mA}$)

f MHz	S ₁₁		S ₂₁		S ₁₂		S ₂₂	
	S ₁₁	∠	S ₂₁	∠	S ₁₂	∠	S ₂₂	∠
30	0.991	-19	15.80	166	0.019	77	0.938	-19
40	0.970	-25	15.50	161	0.025	72	0.933	-25
50	0.959	-31	15.20	156	0.030	67	0.918	-31
60	0.943	-37	14.80	151	0.035	63	0.900	-37
70	0.925	-42	14.30	147	0.040	59	0.880	-42
80	0.912	-48	13.90	143	0.044	56	0.863	-47
85	0.903	-51	13.70	141	0.046	54	0.857	-49
90	0.896	-53	13.50	139	0.048	52	0.851	-52
100	0.872	-58	12.90	135	0.051	48	0.830	-57
110	0.853	-63	12.40	131	0.054	46	0.812	-60
120	0.841	-67	11.90	128	0.056	43	0.796	-63
130	0.831	-71	11.50	126	0.059	40	0.788	-67
140	0.814	-75	11.10	122	0.061	37	0.777	-70
150	0.797	-79	10.70	119	0.063	34	0.760	-74
160	0.782	-82	10.20	117	0.064	32	0.739	-78
170	0.776	-85	9.81	115	0.066	32	0.740	-79
180	0.769	-89	9.55	112	0.068	28	0.737	-83
190	0.754	-92	9.24	109	0.069	25	0.725	-87
200	0.737	-94	8.83	107	0.068	23	0.707	-90
210	0.731	-96	8.47	105	0.068	22	0.692	-92
220	0.730	-99	8.20	103	0.069	21	0.692	-94
230	0.724	-101	7.94	101	0.071	20	0.697	-95
240	0.713	-104	7.69	99	0.072	16	0.696	-99
250	0.705	-106	7.44	97	0.070	15	0.676	-100
260	0.699	-108	7.18	96	0.070	15	0.673	-102
270	0.697	-109	6.91	94	0.070	14	0.661	-103
280	0.697	-111	6.70	93	0.071	13	0.654	-104
290	0.693	-113	6.54	92	0.071	11	0.658	-106
300	0.686	-115	6.36	90	0.072	9	0.664	-108
310	0.679	-116	6.12	88	0.069	7	0.639	-111
320	0.679	-117	5.96	87	0.070	9	0.642	-110
330	0.679	-119	5.80	86	0.070	8	0.648	-112
340	0.679	-121	5.63	84	0.071	7	0.648	-114
350	0.674	-122	5.47	83	0.070	5	0.645	-114
360	0.669	-123	5.33	82	0.070	4	0.650	-116
370	0.667	-124	5.18	80	0.068	3	0.644	-118
380	0.672	-125	5.02	80	0.066	3	0.614	-119
390	0.675	-127	4.96	78	0.071	4	0.655	-116
400	0.672	-129	4.83	77	0.070	2	0.655	-119
410	0.668	-130	4.70	75	0.069	0	0.654	-121
420	0.666	-131	4.56	74	0.067	-1	0.644	-122
430	0.667	-131	4.48	74	0.066	-1	0.646	-122

Table 1. Common Source S-Parameters ($V_{DS} = 12.5\text{ V}$, $I_D = 120\text{ mA}$) (continued)

f MHz	S ₁₁		S ₂₁		S ₁₂		S ₂₂	
	S ₁₁	φ	S ₂₁	φ	S ₁₂	φ	S ₂₂	φ
440	0.671	-132	4.39	72	0.066	-1	0.651	-123
450	0.670	-134	4.29	71	0.068	-1	0.663	-123
460	0.662	-135	4.15	70	0.067	-6	0.677	-127
470	0.663	-135	4.05	69	0.065	-5	0.664	-127
480	0.666	-136	3.95	68	0.064	-5	0.663	-128
490	0.670	-137	3.88	67	0.064	-5	0.663	-128
500	0.670	-138	3.81	66	0.063	-6	0.670	-128
600	0.693	-147	3.06	55	0.053	-17	0.689	-136
700	0.708	-152	2.61	46	0.044	-14	0.723	-142
800	0.731	-158	2.22	40	0.037	-15	0.733	-146
900	0.724	-165	1.93	32	0.037	-32	0.760	-151
1000	0.748	-169	1.73	28	0.027	-6	0.778	-153

Table 2. Common Source S-Parameters ($V_{DS} = 28\text{ V}$, $I_D = 250\text{ mA}$)

f MHz	S ₁₁		S ₂₁		S ₁₂		S ₂₂	
	S ₁₁	φ	S ₂₁	φ	S ₁₂	φ	S ₂₂	φ
30	0.995	-18	15.00	167	0.014	78	0.919	-15
40	0.978	-24	14.70	162	0.018	73	0.913	-19
50	0.971	-30	14.50	158	0.022	69	0.900	-23
60	0.961	-36	14.20	153	0.026	65	0.885	-28
70	0.947	-41	13.80	149	0.029	62	0.867	-32
80	0.938	-46	13.40	145	0.033	58	0.851	-35
85	0.932	-49	13.30	143	0.034	56	0.845	-37
90	0.927	-51	13.10	141	0.036	55	0.839	-39
100	0.908	-56	12.70	138	0.038	51	0.825	-43
110	0.893	-61	12.20	134	0.040	49	0.802	-46
120	0.884	-65	11.80	131	0.043	46	0.788	-48
130	0.875	-69	11.40	128	0.045	44	0.781	-51
140	0.862	-74	11.10	125	0.047	40	0.772	-54
150	0.848	-78	10.70	122	0.048	37	0.754	-57
160	0.836	-81	10.30	119	0.049	35	0.733	-60
170	0.830	-84	9.86	117	0.050	35	0.718	-60
180	0.824	-88	9.64	115	0.053	31	0.729	-64
190	0.813	-91	9.38	112	0.053	29	0.719	-67
200	0.798	-94	9.00	109	0.053	26	0.701	-70
210	0.792	-96	8.63	107	0.053	25	0.682	-72
220	0.790	-98	8.36	105	0.054	24	0.677	-73
230	0.785	-101	8.10	104	0.055	22	0.677	-75
240	0.777	-104	7.92	101	0.057	19	0.694	-78
250	0.769	-106	7.65	99	0.055	18	0.663	-80
260	0.764	-108	7.40	97	0.055	18	0.662	-81
270	0.761	-109	7.13	96	0.055	17	0.649	-82
280	0.760	-111	6.91	95	0.055	16	0.640	-82

Table 2. Common Source S-Parameters ($V_{DS} = 28\text{ V}$, $I_D = 250\text{ mA}$) (continued)

f MHz	S ₁₁		S ₂₁		S ₁₂		S ₂₂	
	S ₁₁	φ	S ₂₁	φ	S ₁₂	φ	S ₂₂	φ
290	0.757	-113	6.75	93	0.055	14	0.641	-84
300	0.751	-115	6.59	91	0.056	12	0.645	-86
310	0.743	-117	6.37	89	0.055	9	0.635	-90
320	0.744	-118	6.17	88	0.054	11	0.619	-89
330	0.744	-120	6.01	87	0.055	11	0.628	-90
340	0.743	-121	5.85	85	0.055	10	0.629	-92
350	0.738	-123	5.70	84	0.055	8	0.629	-92
360	0.733	-124	5.55	82	0.054	6	0.631	-94
370	0.730	-126	5.40	81	0.054	4	0.623	-96
380	0.732	-127	5.21	80	0.052	4	0.593	-98
390	0.737	-129	5.17	79	0.055	7	0.627	-93
400	0.734	-130	5.04	77	0.055	4	0.639	-97
410	0.731	-131	4.92	76	0.054	3	0.641	-99
420	0.728	-132	4.78	75	0.052	1	0.630	-100
430	0.729	-133	4.67	74	0.051	0	0.628	-101
440	0.731	-134	4.57	72	0.051	1	0.626	-102
450	0.731	-136	4.47	71	0.053	1	0.630	-102
460	0.723	-137	4.37	69	0.054	-4	0.673	-106
470	0.724	-137	4.24	68	0.050	-3	0.647	-107
480	0.727	-138	4.13	68	0.049	-3	0.642	-108
490	0.730	-139	4.05	67	0.048	-3	0.641	-107
500	0.730	-140	3.99	66	0.048	-4	0.647	-108
600	0.736	-150	3.54	56	0.037	-14	0.657	-118
700	0.745	-156	2.99	46	0.029	-9	0.699	-126
800	0.765	-161	2.54	39	0.025	-5	0.713	-131
900	0.759	-168	2.20	31	0.022	-34	0.742	-136
1000	0.769	-173	1.98	27	0.018	19	0.756	-139

PACKAGE DIMENSIONS

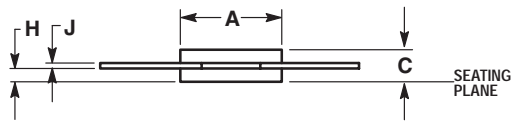
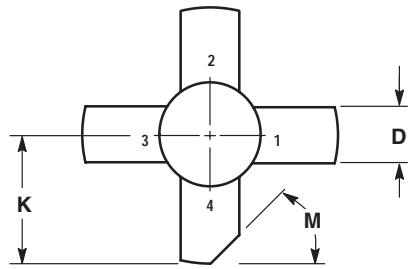

NOTES:

1. DIMENSIONING AND TOLERANCING PER ANSI Y14.5M, 1982.
2. CONTROLLING DIMENSION: INCH.
3. SEATING PLANE = GROUND AND IS CONNECTED TO PIN 1 AND 3.

DIM	INCHES		MILLIMETERS	
	MIN	MAX	MIN	MAX
A	0.271	0.286	6.88	7.26
C	0.112	0.136	2.84	3.45
D	0.215	0.235	5.46	5.97
H	0.055	0.065	1.40	1.65
J	0.003	0.007	0.08	0.18
K	0.435	---	11.05	---
M	45° REF		45° REF	

STYLE 3:

- PIN 1. SOURCE
2. GATE
3. SOURCE
4. DRAIN

**CASE 249-06
ISSUE H**

Specifications subject to change without notice.

- **North America:** Tel. (800) 366-2266, Fax (800) 618-8883
- **Asia/Pacific:** Tel.+81-44-844-8296, Fax +81-44-844-8298
- **Europe:** Tel. +44 (1344) 869 595, Fax+44 (1344) 300 020

Visit www.macom.com for additional data sheets and product information.

REV 5

tyco / Electronics

MACOM