

MOTOROLA
SEMICONDUCTOR
 TECHNICAL DATA

Designer's Data Sheet
Power Field Effect Transistor
N-Channel Enhancement-Mode
Silicon Gate

This Logic Level TMOS Power FET is designed for high speed power switching applications such as switching regulators, converters, solenoid and relay drivers.

- Low Drive Requirement to Interface Power Loads to Logic Level ICs or Microprocessors — $V_{GS(th)} = 2$ Volts max
- Silicon Gate for Fast Switching Speeds — Switching Times Specified at 100°C
- Designer's Data — I_{DSS} , $V_{DS(on)}$, $V_{GS(th)}$ and SOA Specified at Elevated Temperature
- Rugged — SOA is Power Dissipation Limited
- Source-to-Drain Diode Characterized for Use With Inductive Loads



MTP15N05EL
 Motorola Preferred Device

TMOS POWER FET
 LOGIC LEVEL
 15 AMPERES
 $R_{DS(on)} = 0.1$ OHM
 50 VOLTS

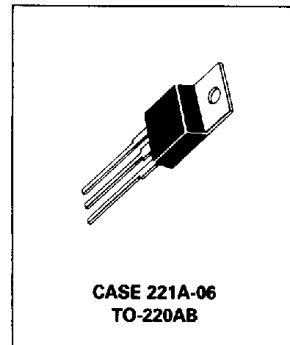
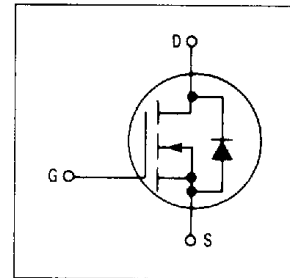

MAXIMUM RATINGS

Rating	Symbol	Value	Unit
Drain-Source Voltage	V_{DSS}	50	Vdc
Drain-Gate Voltage ($R_{GS} = 1$ M Ω)	V_{DGR}	50	Vdc
Gate-Source Voltage	V_{GS} V_{GSM}	± 15	Vdc
Continuous Non-repetitive ($t_p \leq 50$ μ s)		± 20	Vpk
Drain Current — Continuous	I_D	15	Adc
— Pulsed	I_{DM}	40	
Total Power Dissipation @ $T_C = 25^\circ\text{C}$	P_D	75	Watts
Derate above 25°C		0.6	W/°C
Operating and Storage Temperature Range	T_J, T_{stg}	-65 to 150	°C

THERMAL CHARACTERISTICS

Thermal Resistance	Symbol	Value	Unit
Junction to Case	$R_{\theta JC}$	1.67	°C/W
Junction to Ambient	$R_{\theta JA}$	30	
MTM15N05L/06L MTP15N05L/06L		62.5	
Maximum Lead Temp. for Soldering Purposes, 1/8" from case for 5 seconds	T_L	260	°C

ELECTRICAL CHARACTERISTICS ($T_C = 25^\circ\text{C}$ unless otherwise noted)

Characteristic	Symbol	Min	Max	Unit
----------------	--------	-----	-----	------

OFF CHARACTERISTICS

Drain-Source Breakdown Voltage ($V_{GS} = 0, I_D = 1$ mA)	$V_{(BR)DSS}$	50	—	Vdc
MTM/MTP15N05L MTM/MTP15N06L		60	—	
Zero Gate Voltage Drain Current ($V_{DS} =$ Rated $V_{DSS}, V_{GS} = 0$)	I_{DSS}	—	1	μ Adc
($V_{DS} =$ Rated $V_{DSS}, V_{GS} = 0, T_J = 125^\circ\text{C}$)		—	50	

(continued)

Designer's Data for "Worst Case" Conditions — The Designer's Data Sheet permits the design of most circuits entirely from the information presented SOA Limit curves — representing boundaries on device characteristics — are given to facilitate "worst case" design

Preferred device is a Motorola recommended choice for future use and best overall value.

ELECTRICAL CHARACTERISTICS — continued ($T_C = 25^\circ\text{C}$ unless otherwise noted)

Characteristic	Symbol	Min	Max	Unit
----------------	--------	-----	-----	------

OFF CHARACTERISTICS (continued)

Gate-Body Leakage Current, Forward ($V_{GSF} = 15\text{ Vdc}$, $V_{DS} = 0$)	I_{GSSF}	—	100	nAdc
Gate Body Leakage Current, Reverse ($V_{GSR} = 15\text{ Vdc}$, $V_{DS} = 0$)	I_{GSSR}	—	100	nAdc

ON CHARACTERISTICS

Gate Threshold Voltage ($V_{DS} = V_{GS}$, $I_D = 1\text{ mA}$) ($T_J = 100^\circ\text{C}$)	$V_{GS(th)}$	1 0.75	2 1.5	Vdc
Static Drain-Source On-Resistance ($V_{GS} = 5\text{ Vdc}$, $I_D = 7.5\text{ Adc}$)	$R_{DS(on)}$	—	0.1	Ohm
Drain-Source On-Voltage ($V_{GS} = 5\text{ V}$) ($I_D = 15\text{ Adc}$) ($I_D = 7.5\text{ Adc}$, $T_J = 100^\circ\text{C}$)	$V_{DS(on)}$	— —	3 1.5	Vdc
Forward Transconductance ($V_{DS} = 15\text{ V}$, $I_D = 7.5\text{ A}$)	g_{FS}	5	—	mhos

DYNAMIC CHARACTERISTICS

Input Capacitance	$V_{DS} = 25\text{ V}$, $V_{GS} = 0$, $f = 1\text{ MHz}$	C_{iss}	—	900	pF
	$V_{GS} = 15\text{ V}$, $V_{DS} = 0$, $f = 1\text{ MHz}$ See Figure 4		—	2800	
Reverse Transfer Capacitance	$V_{DS} = 25\text{ V}$, $V_{GS} = 0$, $f = 1\text{ MHz}$	C_{rss}	—	200	pF
	$V_{GS} = 15\text{ V}$, $V_{DS} = 0$, $f = 1\text{ MHz}$ See Figure 4		—	2400	
Output Capacitance	$V_{DS} = 25\text{ V}$, $V_{GS} = 0$, $f = 1\text{ MHz}$ See Figure 4	C_{oss}	—	450	pF

SWITCHING CHARACTERISTICS ($T_J = 100^\circ\text{C}$)

Turn-On Delay Time	$(V_{DD} = 25\text{ V}$, $I_D = 7.5\text{ A}$, $V_{GS} = 5\text{ V}$, $R_{gen} = 50\text{ ohms}$)	$t_{d(on)}$	—	40	ns
Rise Time		t_r	—	260	
Turn-Off Delay Time		$t_{d(off)}$	—	200	
Fall Time		t_f	—	200	
Total Gate Charge	$(V_{DS} = 0.8\text{ Rated } V_{DSS}$, $I_D = 15\text{ A}$, $V_{GS} = 5\text{ Vdc}$) See Figures 6 and 10.	Q_g	14 (typ)	22	nC
Gate-Source Charge		Q_{gs}	7 (typ)	—	
Gate-Drain Charge		Q_{gd}	7 (typ)	—	

SOURCE DRAIN DIODE CHARACTERISTICS

Forward On-Voltage	$(I_S = \text{Rated } I_D, V_{GS} = 0)$	V_{SD}	1.8 (typ)	—	Vdc
Forward Turn-On Time		t_{on}	Limited by stray inductance		
Reverse Recovery Time		t_{rr}	300 (typ)	—	ns

INTERNAL PACKAGE INDUCTANCE (TO-220)

Internal Drain Inductance (Measured from the contact screw on tab to center of die) (Measured from the drain lead 0.25" from package to center of die)	L_d	3.5 (Typ) 4.5 (Typ)	— —	nH
Internal Source Inductance (Measured from the source lead 0.25" from package to source bond pad.)	L_s	7.5 (Typ)	—	

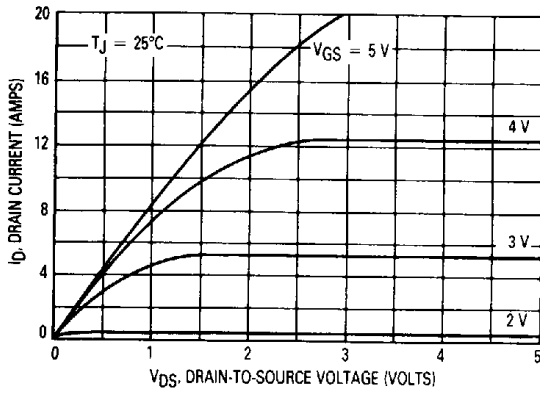

Figure 1. On-Region Characteristics

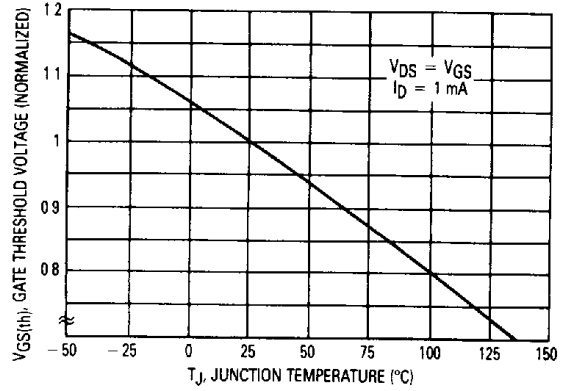

Figure 2. Gate-Threshold Voltage Variation With Temperature

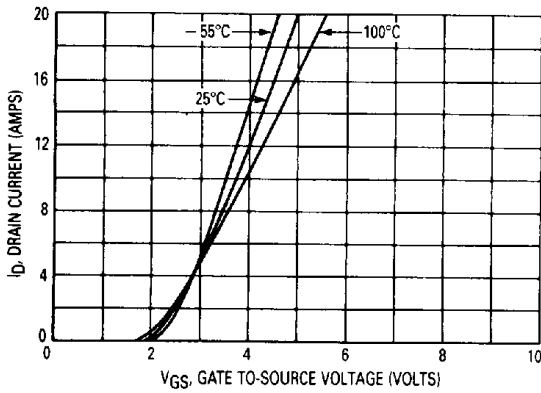

Figure 3. Transfer Characteristics

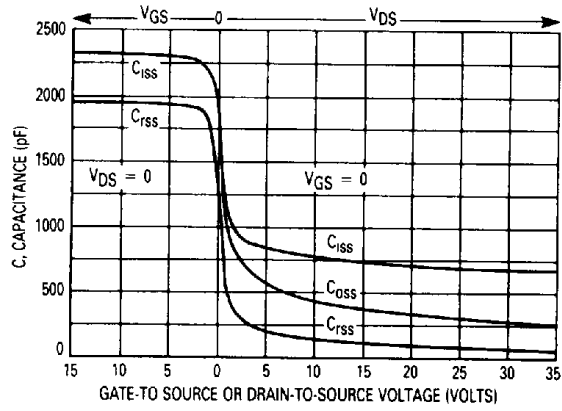

Figure 4. Capacitance Variation

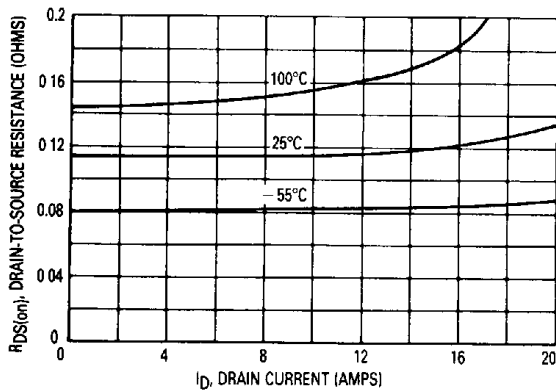

Figure 5. On-Resistance versus Drain Current

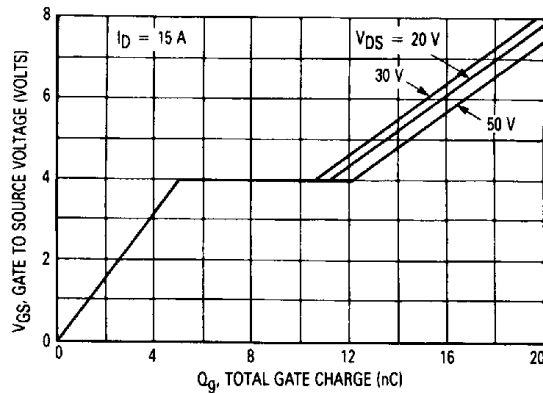

Figure 6. Gate Charge Variation

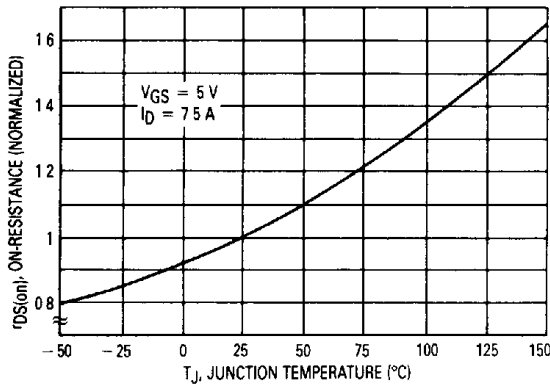

Figure 7. On-Resistance Variation with Temperature

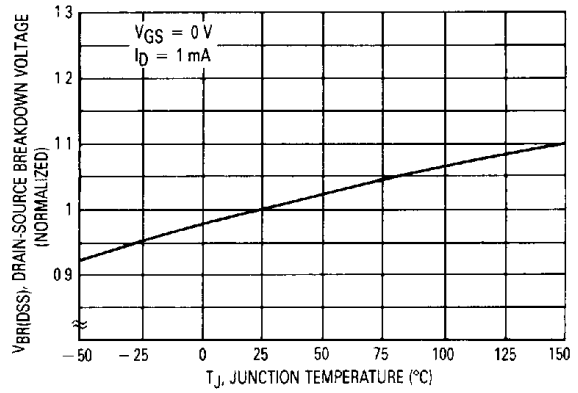

Figure 8. Drain-Source Breakdown Voltage Variation with Temperature

3

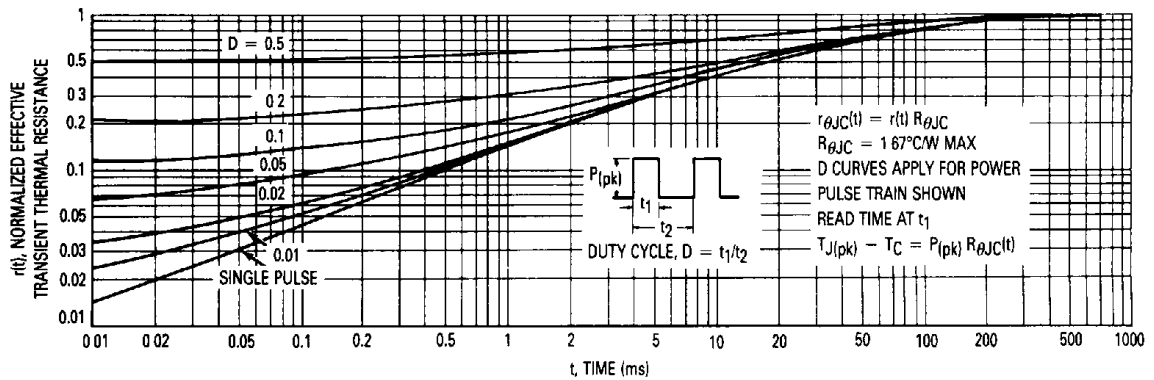
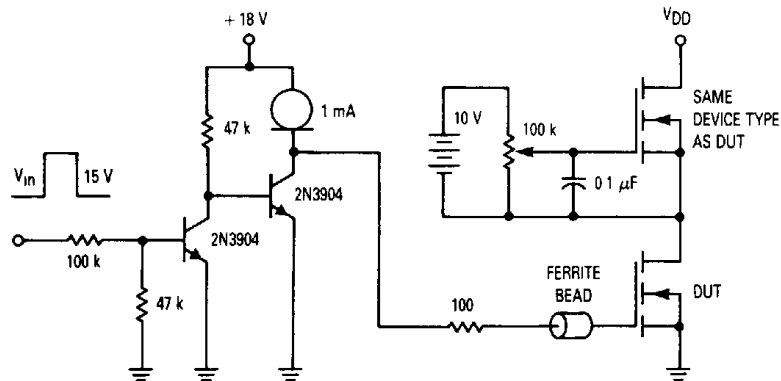

Figure 9. Thermal Response



$V_{in} = 15 V_{pk}$; PULSE WIDTH $\leq 100 \mu s$, DUTY CYCLE $\leq 10\%$

Figure 10. Gate Charge Test Circuit

SAFE OPERATING AREA INFORMATION

FORWARD BIASED SAFE OPERATING AREA

The FBSOA curves define the maximum drain-to-source voltage and drain current that a device can safely handle when it is forward biased, or when it is on, or being turned on. Because these curves include the limitations of simultaneous high voltage and high current, up to the rating of the device, they are especially useful to designers of linear systems. The curves are based on a case temperature of 25°C and a maximum junction temperature of 150°C. Limitations for repetitive pulses at various case temperatures can be determined by using the thermal response curves. Motorola Application Note, AN569, "Transient Thermal Resistance-General Data and its Use" provides detailed instructions.

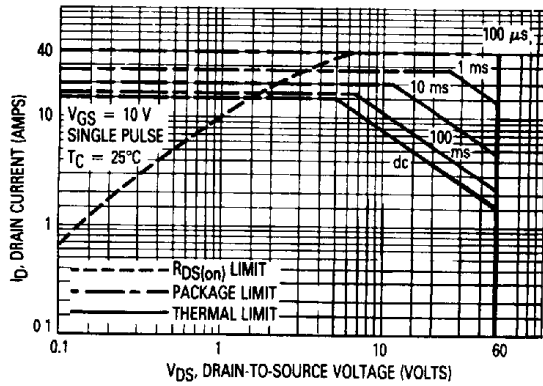

Figure 11. Maximum Rated Forward Biased Safe Operating Area

SWITCHING SAFE OPERATING AREA

The switching safe operating area (SOA) of Figure 12 is the boundary that the load line may traverse without incurring damage to the MOSFET. The fundamental limits are the peak current, IDM and the breakdown voltage, V(BR)DSS. The switching SOA shown in Figure 12 is applicable for both turn-on and turn-off of the devices for switching times less than one microsecond.

The power averaged over a complete switching cycle must be less than:

$$\frac{T_{J(max)} - T_C}{R_{\theta JC}}$$

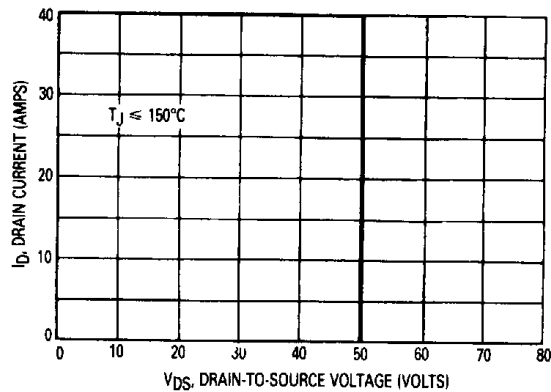

Figure 12. Maximum Rated Switching Safe Operating Area