

HiPerFAST™ IGBT with Diode Combi Pack

IXGH 24N60AU1
IXGH 24N60AU1S

$V_{CES} = 600\text{ V}$
 $I_{C25} = 48\text{ A}$
 $V_{CE(sat)} = 2.7\text{ V}$
 $t_{fi} = 275\text{ ns}$

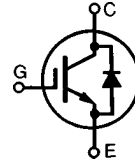

Symbol	Test Conditions	Maximum Ratings	
V_{CES}	$T_J = 25^\circ\text{C}$ to 150°C	600	V
V_{CGR}	$T_J = 25^\circ\text{C}$ to 150°C ; $R_{GE} = 1\text{ M}\Omega$	600	V
V_{GES}	Continuous	± 20	V
V_{GEM}	Transient	± 30	V
I_{C25}	$T_C = 25^\circ\text{C}$	48	A
I_{C90}	$T_C = 90^\circ\text{C}$	24	A
I_{CM}	$T_C = 25^\circ\text{C}$, 1 ms	96	A
SSOA (RBSOA)	$V_{GE} = 15\text{ V}$, $T_{VJ} = 125^\circ\text{C}$, $R_G = 22\ \Omega$ Clamped inductive load, $L = 100\ \mu\text{H}$	$I_{CM} = 48$ @ $0.8 V_{CES}$	A
P_C	$T_C = 25^\circ\text{C}$	150	W
T_J		-55 ... +150	$^\circ\text{C}$
T_{JM}		150	$^\circ\text{C}$
T_{stg}		-55 ... +150	$^\circ\text{C}$
Maximum Lead and Tab temperature for soldering 1.6 mm (0.062 in.) from case for 10 s		300	$^\circ\text{C}$
M_d	Mounting torque, TO-247 AD	1.13/10	Nm/lb.in.
Weight	TO-247 SMD	4	g
	TO-247 AD	6	g

**TO-247 SMD
(24N60AU1S)**

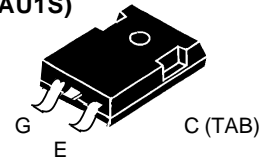

**TO-247 AD
(24N60AU1)**

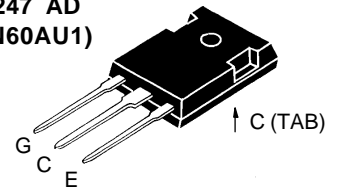

G = Gate, C = Collector,
E = Emitter, TAB = Collector

Features

- International standard packages JEDEC TO-247 SMD surface mountable and JEDEC TO-247 AD
- IGBT and anti-parallel FRED in one package
- 2nd generation HDMOS™ process
- Low $V_{CE(sat)}$
 - for minimum on-state conduction losses
- MOS Gate turn-on
 - drive simplicity
- Fast Recovery Epitaxial Diode (FRED)
 - soft recovery with low I_{RM}

Applications

- AC motor speed control
- DC servo and robot drives
- DC choppers
- Uninterruptible power supplies (UPS)
- Switch-mode and resonant-mode power supplies

Advantages

- Space savings (two devices in one package)
- Easy to mount with 1 screw, TO-247 (isolated mounting screw hole)
- Reduces assembly time and cost

Symbol	Test Conditions	Characteristic Values ($T_J = 25^\circ\text{C}$, unless otherwise specified)		
		min.	typ.	max.
BV_{CES}	$I_C = 750\ \mu\text{A}$, $V_{GE} = 0\text{ V}$	600		V
$V_{GE(th)}$	$I_C = 250\ \mu\text{A}$, $V_{CE} = V_{GE}$	2.5		5.5 V
I_{CES}	$V_{CE} = 0.8 \cdot V_{CES}$ $V_{GE} = 0\text{ V}$		$T_J = 25^\circ\text{C}$ $T_J = 125^\circ\text{C}$	500 μA 8 mA
I_{GES}	$V_{CE} = 0\text{ V}$, $V_{GE} = \pm 20\text{ V}$			$\pm 100\text{ nA}$
$V_{CE(sat)}$	$I_C = I_{C90}$, $V_{GE} = 15\text{ V}$			2.7 V

Symbol	Test Conditions	Characteristic Values ($T_J = 25^\circ\text{C}$, unless otherwise specified)		
		min.	typ.	max.
g_{fs}	$I_C = I_{C90}$; $V_{CE} = 10\text{ V}$, Pulse test, $t \leq 300\ \mu\text{s}$, duty cycle $\leq 2\%$	9	13	S
C_{ies} C_{oes} C_{res}	$V_{CE} = 25\text{ V}$, $V_{GE} = 0\text{ V}$, $f = 1\text{ MHz}$		1500	pF
			175	pF
			40	pF
Q_g Q_{ge} Q_{gc}	$I_C = I_{C90}$, $V_{GE} = 15\text{ V}$, $V_{CE} = 0.5 V_{CES}$		90	nC
			11	nC
			30	nC
$t_{d(on)}$ t_{ri} E_{on} $t_{d(off)}$ t_{fi} E_{off}	Inductive load, $T_J = 25^\circ\text{C}$ $I_C = I_{C90}$, $V_{GE} = 15\text{ V}$, $L = 100\ \mu\text{H}$, $V_{CE} = 0.8 V_{CES}$, $R_G = R_{off} = 10\ \Omega$ Remarks: Switching times may increase for $V_{CE}(\text{Clamp}) > 0.8 \cdot V_{CES}$, higher T_J or increased R_G	25 15 0.6 150 110 1.5		ns ns mJ ns ns mJ
$t_{d(on)}$ t_{ri} E_{on} $t_{d(off)}$ t_{fi} E_{off}	Inductive load, $T_J = 125^\circ\text{C}$ $I_C = I_{C90}$, $V_{GE} = 15\text{ V}$, $L = 100\ \mu\text{H}$, $V_{CE} = 0.8 V_{CES}$, $R_G = R_{off} = 10\ \Omega$ Remarks: Switching times may increase for $V_{CE}(\text{Clamp}) > 0.8 \cdot V_{CES}$, higher T_J or increased R_G	25 15 0.8 250 400 2.3		ns ns mJ ns ns mJ
R_{thJC} R_{thCK}		0.25		0.83 K/W K/W

Symbol	Test Conditions	Characteristic Values ($T_J = 25^\circ\text{C}$, unless otherwise specified)		
		min.	typ.	max.
V_F	$I_F = I_{C90}$, $V_{GE} = 0\text{ V}$, Pulse test, $t \leq 300\ \mu\text{s}$, duty cycle $d \leq 2\%$			1.6 V
I_{RM} t_{rr}	$I_F = I_{C90}$, $V_{GE} = 0\text{ V}$, $-di_F/dt = 240\text{ A}/\mu\text{s}$ $V_R = 360\text{ V}$, $T_J = 125^\circ\text{C}$ $I_F = 1\text{ A}$; $-di/dt = 100\text{ A}/\mu\text{s}$; $V_R = 30\text{ V}$, $T_J = 25^\circ\text{C}$		10 150	A ns
			35	50 ns
R_{thJC}				1 K/W

Min. Recommended Footprint (Dimensions in inches and (mm))

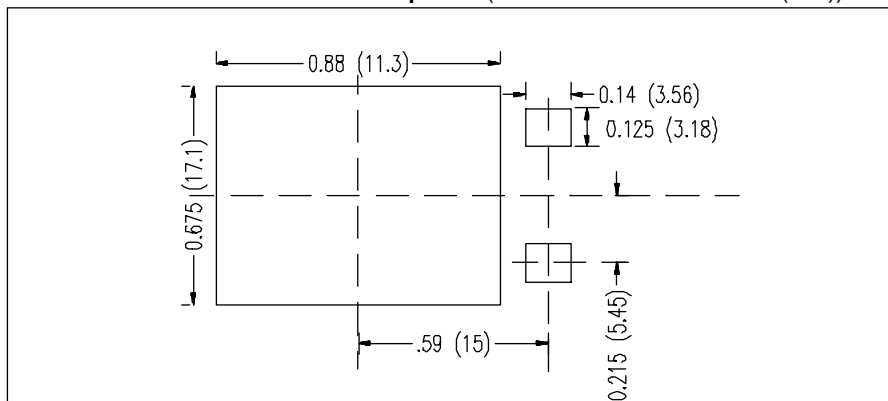

TO-247 AD Outline

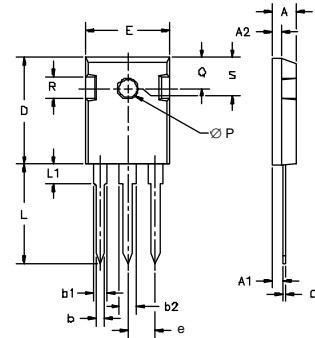

Dim.	Millimeter		Inches	
	Min.	Max.	Min.	Max.
A	4.7	5.3	.185	.209
A ₁	2.2	2.54	.087	.102
A ₂	2.2	2.6	.059	.098
b	1.0	1.4	.040	.055
b ₁	1.65	2.13	.065	.084
b ₂	2.87	3.12	.113	.123
C	.4	.8	.016	.031
D	20.80	21.46	.819	.845
E	15.75	16.26	.610	.640
e	5.20	5.72	0.205	0.225
L	19.81	20.32	.780	.800
L ₁		4.50		.177
∅P	3.55	3.65	.140	.144
Q	5.89	6.40	0.232	0.252
R	4.32	5.49	.170	.216
S	6.15	BSC	.242	BSC

TO-247 SMD Outline

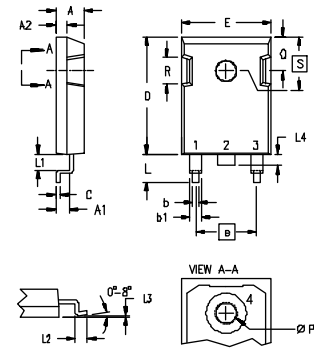

- Gate
- Collector
- Emitter
- Collector

Dim.	Millimeter		Inches	
	Min.	Max.	Min.	Max.
A	4.83	5.21	.190	.205
A ₁	2.29	2.54	.090	.100
A ₂	1.91	2.16	.075	.085
b	1.14	1.40	.045	.055
b ₁	1.91	2.13	.075	.084
C	0.61	0.80	.024	.031
D	20.80	21.34	.819	.840
E	15.75	16.13	.620	.635
e	5.45	BSC	.215	BSC
L	4.90	5.10	.193	.201
L ₁	2.70	2.90	.106	.114
L ₂	2.10	2.30	.083	.091
L ₃	0.00	0.10	.00	.004
L ₄	1.90	2.10	.075	.083
∅P	3.55	3.65	.140	.144
Q	5.59	6.20	.220	.244
R	4.32	4.83	.170	.190
S	6.15	BSC	.242	BSC

IXYS reserves the right to change limits, test conditions, and dimensions.

IXYS MOSFETS and IGBTs are covered by one or more of the following U.S. patents: 4,835,592 4,881,106 5,017,508 5,049,961 5,187,117 5,486,715
4,850,072 4,931,844 5,034,796 5,063,307 5,237,481 5,381,025

Fig. 1 Saturation Characteristics

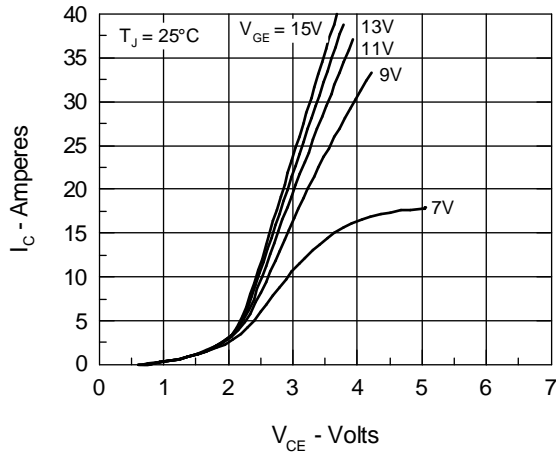

Fig. 2 Output Characteristics

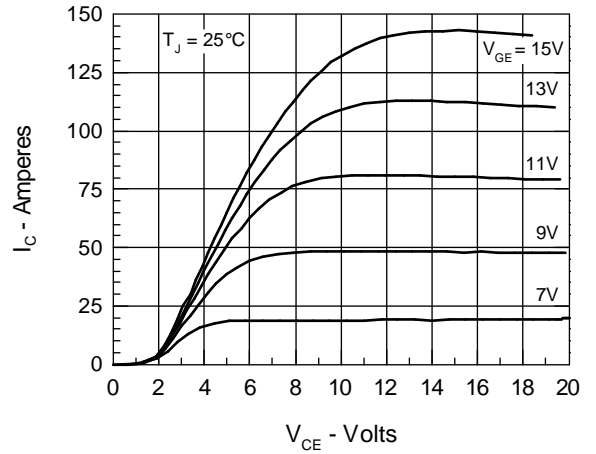

Fig. 3 Collector-Emitter Voltage vs. Gate-Emitter Voltage

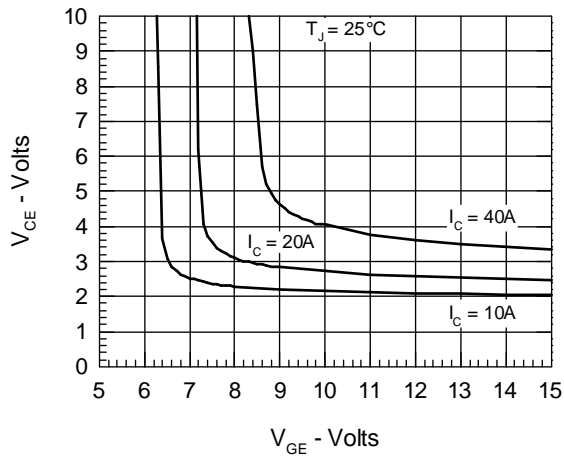

Fig. 4 Temperature Dependence of Output Saturation Voltage

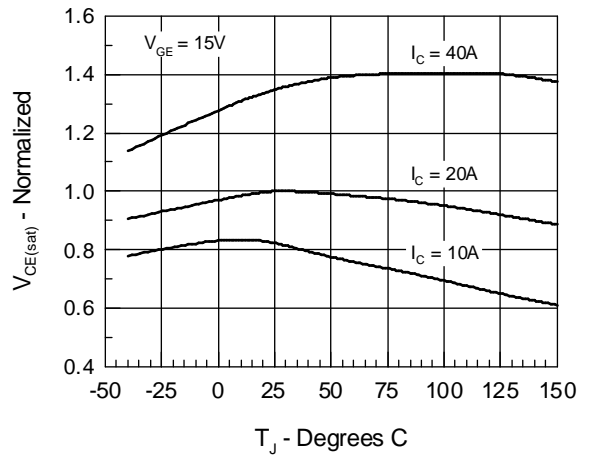

Fig. 5 Input Admittance

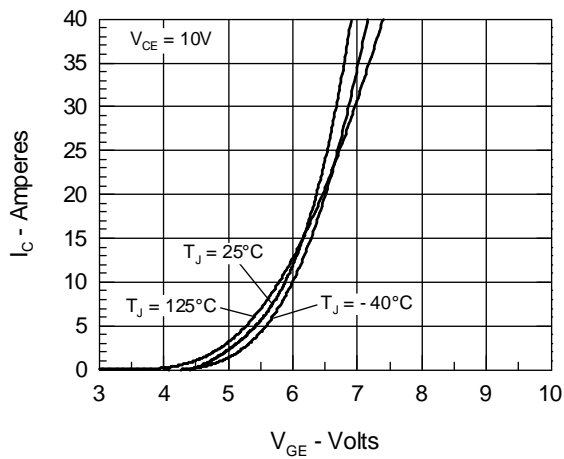
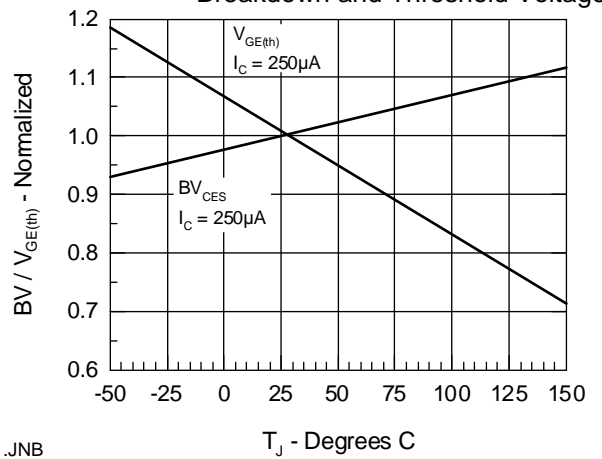

Fig. 6 Temperature Dependence of Breakdown and Threshold Voltage



G20N60p1.JNB

Fig.7 Turn-Off Energy per Pulse and Fall Time on Collector Current

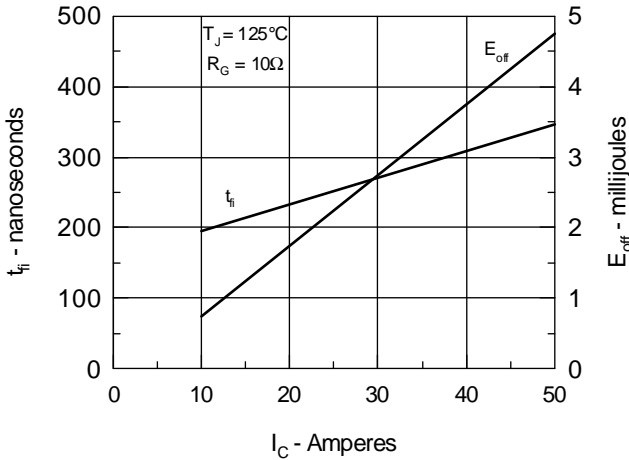

Fig.8 Dependence of Turn-Off Energy Per Pulse and Fall Time on R_G

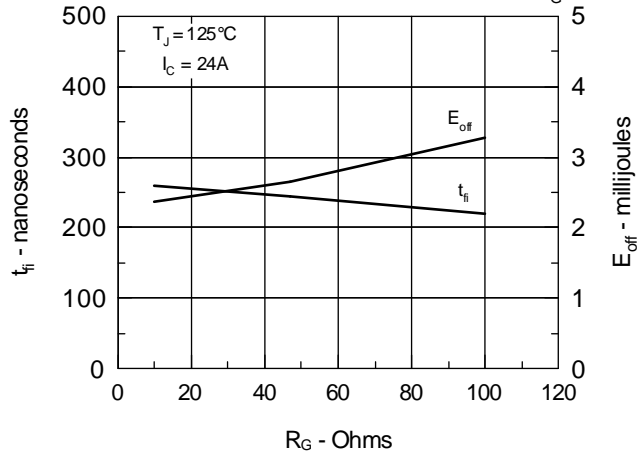

Fig.9 Gate Charge Characteristic Curve

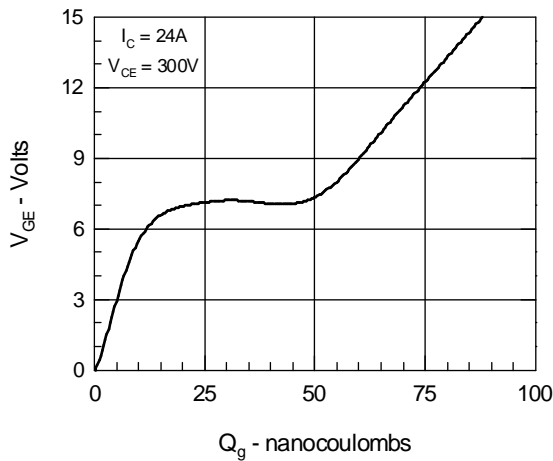

Fig.10 Turn-Off Safe Operating Area

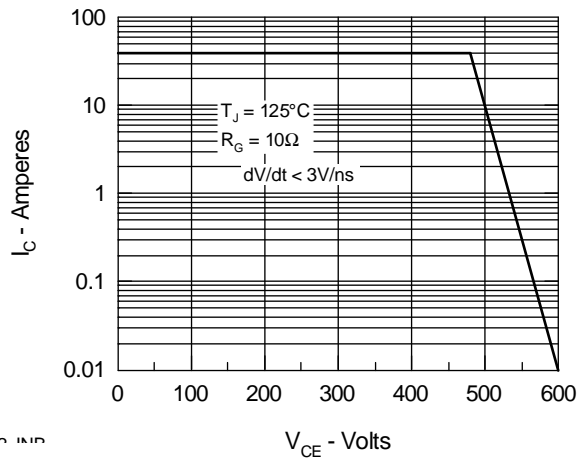
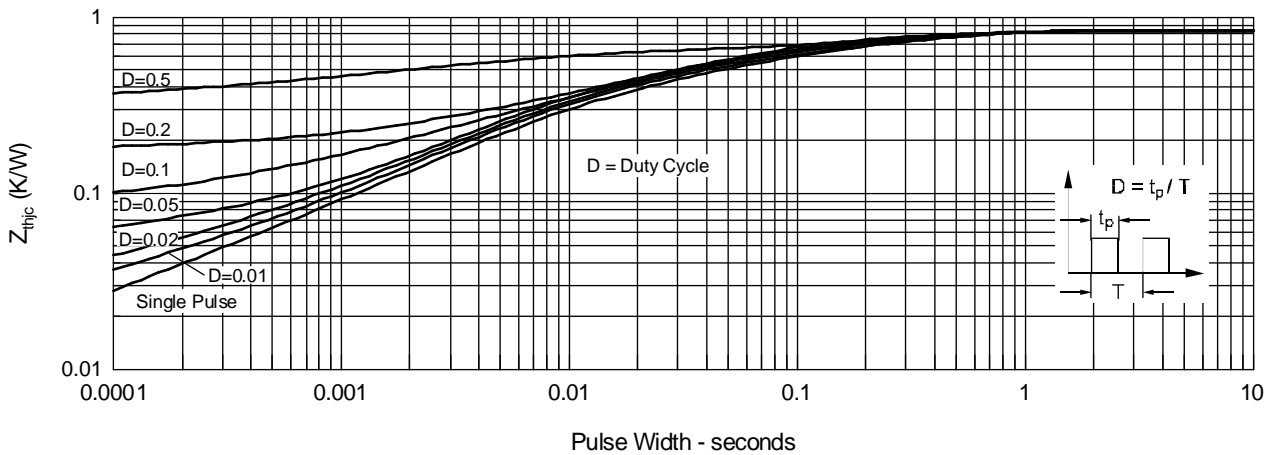

Fig.11 Transient Thermal Impedance



IXYS reserves the right to change limits, test conditions, and dimensions.

IXYS MOSFETS and IGBTs are covered by one or more of the following U.S. patents: 4,835,592 4,881,106 5,017,508 5,049,961 5,187,117 5,486,715
4,850,072 4,931,844 5,034,796 5,063,307 5,237,481 5,381,025

Fig.12 Maximum Forward Voltage Drop

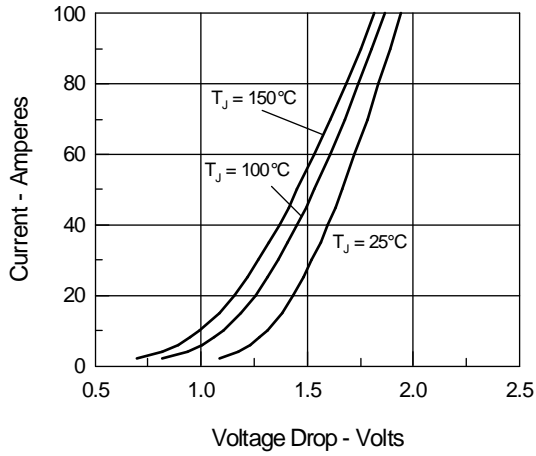

Fig.13 Peak Forward Voltage V_{FR} and Forward Recovery Time t_{FR}

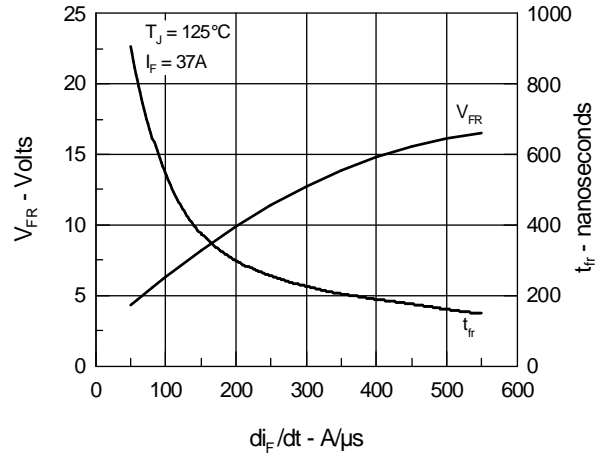

Fig.14 Junction Temperature Dependence off I_{RM} and Q_r

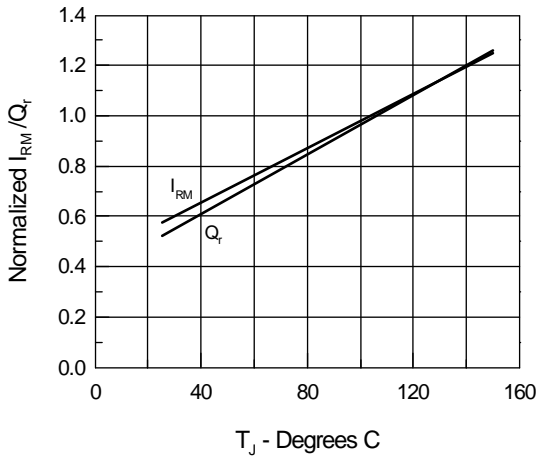

Fig.15 Reverse Recovery Charge

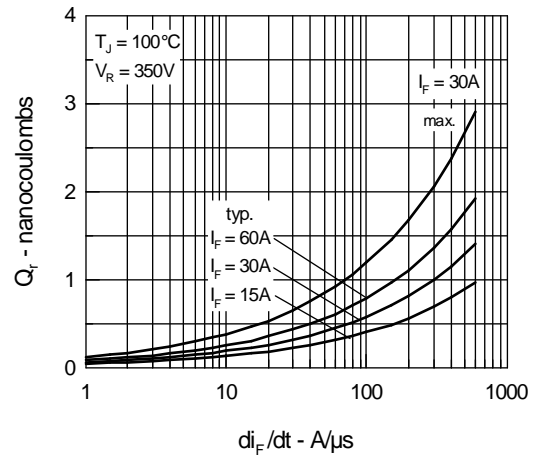

Fig.16 Peak Reverse Recovery Current

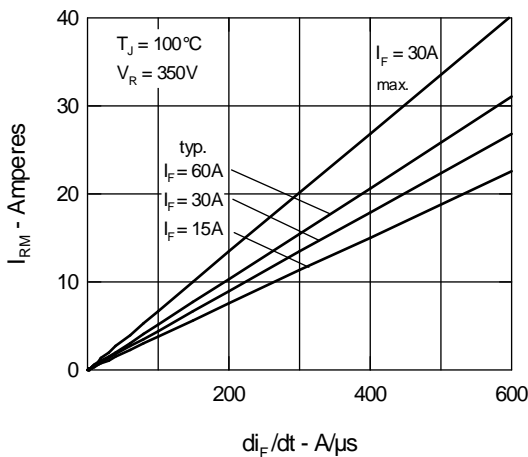

Fig.17 Reverse Recovery Time

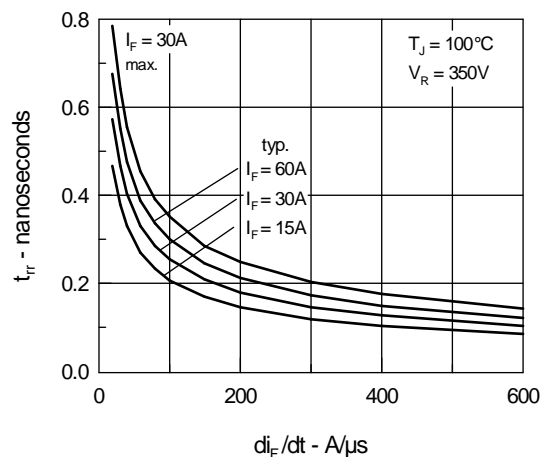
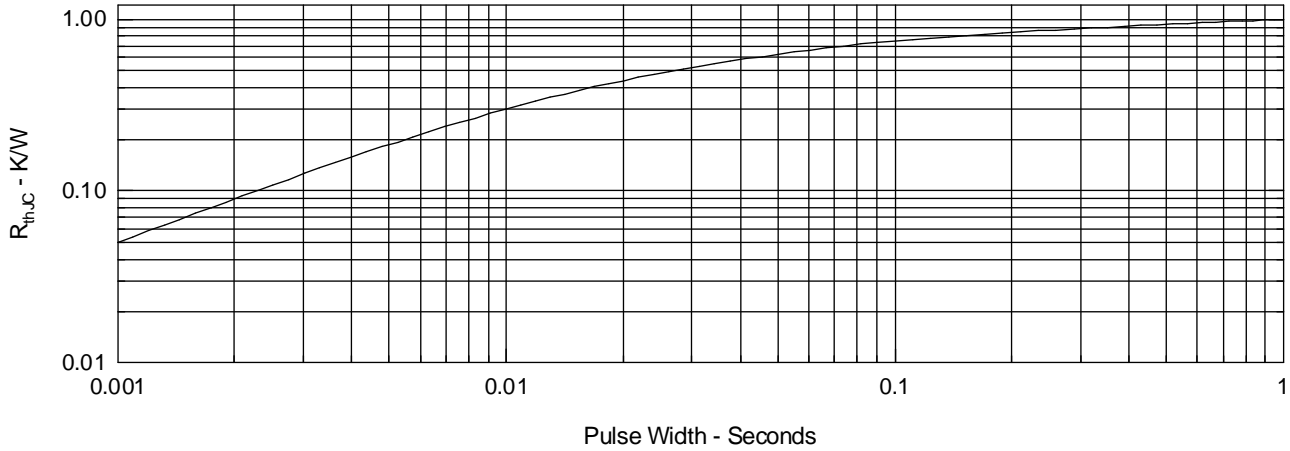

Fig.17 Diode Transient Thermal resistance junction to case



IXYS reserves the right to change limits, test conditions, and dimensions.

IXYS MOSFETS and IGBTs are covered by one or more of the following U.S. patents:

4,835,592	4,881,106	5,017,508	5,049,961	5,187,117	5,486,715
4,850,072	4,931,844	5,034,796	5,063,307	5,237,481	5,381,025