

LTR	REVISION	DATE	APPD
A		12-09-05	RM

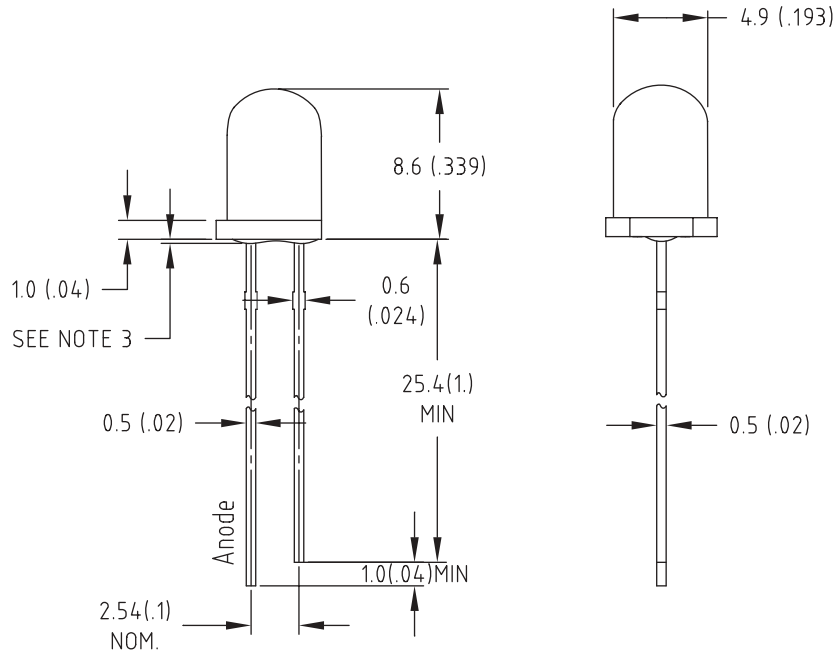
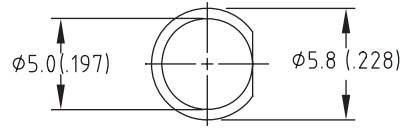

CHIP MATERIAL	LENS COLOR	EMISSION COLOR
GainN	WATER CLEAR	WARM WHITE

Notes:

1. ALL DIMS ARE IN MILLIMETERS (INCHES).
2. TOLERANCE IS $\pm 0.25\text{mm}$ ($\pm 0.010''$) UNLESS OTHERWISE SPECIFIED.
3. PROTRUDED RESIN UNDER FLANGE IS 1.0mm (.04") MAX.
4. LEAD SPACING IS MEASURED WHERE LEADS EMERGE FROM THE PACKAGE.
5. LEADS TO BE SOLDERABLE AND CAPABLE OF MEETING THE SOLDERABILITY REQUIREMENTS OF MIL-STD-202, METHOD 208.
6. MANUFACTURE DATE SHALL NOT BE OLDER THAN 26 WEEKS (6 MONTHS).

ATTENTION
OBSERVE PRECAUTIONS
FOR HANDLING-
ELECTROSTATIC
SENSITIVE
DEVICES

 23105 KASHIWA COURT TORRANCE, CA 90505	-PROPRIETARY- <small>This document contains Proprietary information of LEDTRONICS, INC. It may not be copied, used or disclosed for any purpose without the prior express written consent of LEDTRONICS, INC.</small>	TITLE L200-0WW-40D			
	<small>.XXX ± .010 TOLERANCE PER ANSI-Y14.5 .XX ± .025 (UNLESS OTHERWISE STATED) ANGLES ± 0°, 30' FRACT. ± 1/32</small>	DWG NO DSDC311	SCALE 2:1	SHEET 1 OF 3	DATE 06-16-03
		CODE IDENT NO. 8Z410	DWG BY JG	CHK BY QA	MNFG CUSTOMER

LTR	REVISION	DATE	APPD
A		12-09-05	RM

Absolute Maximum Ratings at Ta 25°C

Parameter	MAX.	Unit
Power Dissipation	120	mW
Peak Forward Current (1/10 Duty Cycle, 0.1ms Pulse Width)	100	mA
Continuous Forward Current	30	mA
Derating Linear From 50°C	0.4	mA/°C
Reverse Voltage	5	V
Electrostatic Discharge (ESD)	150	V
Operating Temperature Range	-40°C to +80°C	
Storage Temperature Range	-40°C to +100°C	
Lead Soldering Temperature [4mm (.157) From Body]	260°C for 5 Seconds	

Electrical Optical Characteristics at Ta=25°C

Parameter	Symbol	Min.	Typ.	Max.	Unit	Test Condition
Luminous Intensity	I _v	2000	2500	3000	mcd	I _f =20mA (Note 1)
Viewing Angle	2θ _{1/2}	45	50	55	Deg	(Note 2)
Forward Voltage	V _f	2.8	3.5	4.0	V	I _f =20mA
Reverse Current	I _R	---	---	100	μA	V _R =5V
SCP	---	---	---	---	---	---
Lumens	---	---	---	---	---	---
Radiant Intensity	---	---	---	---	μW/sr	---

Color Rank	Bin Limits (CIE1931x,y coordinates)							
	Lower Left		Lower Right		Upper Right		Upper Left	
	x	y	x	y	x	y	x	y
BIN C	0.27	0.29	0.30	0.27	0.28	0.24	0.25	0.26
BIN D	0.30	0.33	0.33	0.31	0.30	0.27	0.27	0.29

Notes:

- Luminous intensity is measured with a light sensor and filter combination that approximates the CIE eye-response curve.
- θ_{1/2} is the off-axis at which the luminous intensity is half the axial luminous intensity.



-PROPRIETARY-
 This document contains Proprietary information of LEDTRONICS, INC.™
 It may not be copied, used or disclosed for any purpose without the prior express written consent of LEDTRONICS, INC.™

.XXX ± .010 TOLERANCE PER ANSI-Y14.5
 .XX ± .025 (UNLESS OTHERWISE STATED)
 ANGLES ± 0°, 30'
 FRACT. ± 1/32

TITLE L200-0WW-40D					
DWG NO DSDC311-A		SCALE NTS	SHEET 2 OF 3	DATE 12-09-05	
CODE IDENT NO. 8Z410	DWG BY RM	CHK BY	QA	MNFG	CUSTOMER

Typical Electrical / Optical Characteristics Curves (25°C Ambient Temperature Unless Otherwise Noted)

LTR	REVISION	DATE	APPD
A		12-09-05	RM

CIE 1931 Chromaticity Diagram

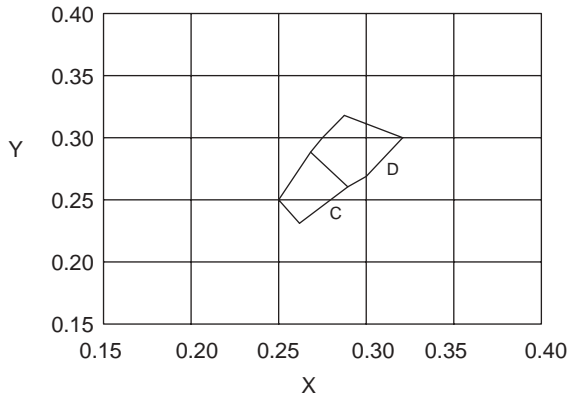

Relative Luminous Intensity vs. Forward Current

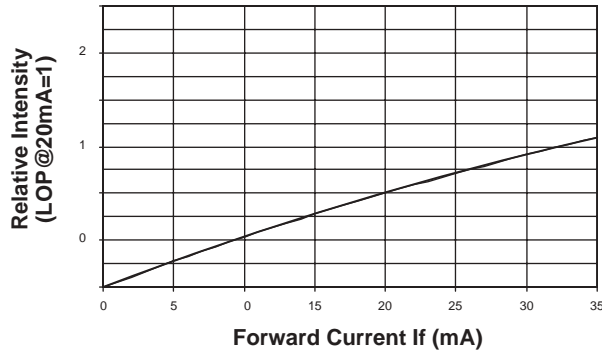

Forward Current vs. Chromaticity Coordinates

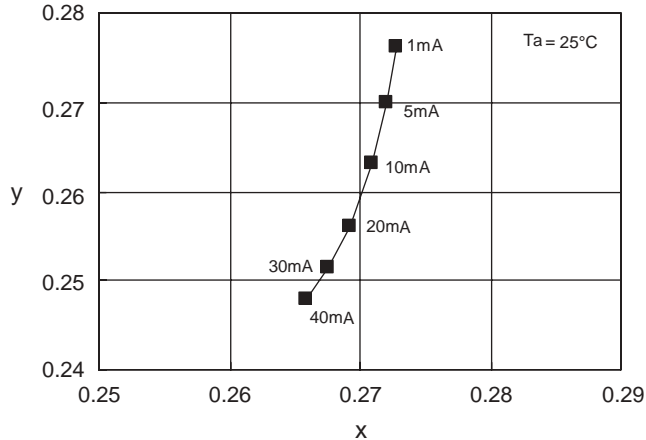

Spectral Radiance

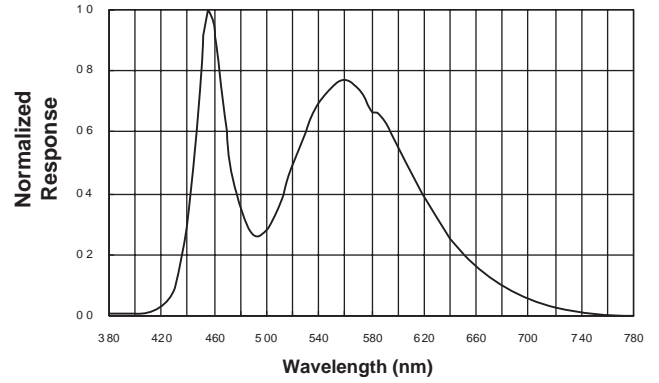

Forward Current vs. Forward voltage

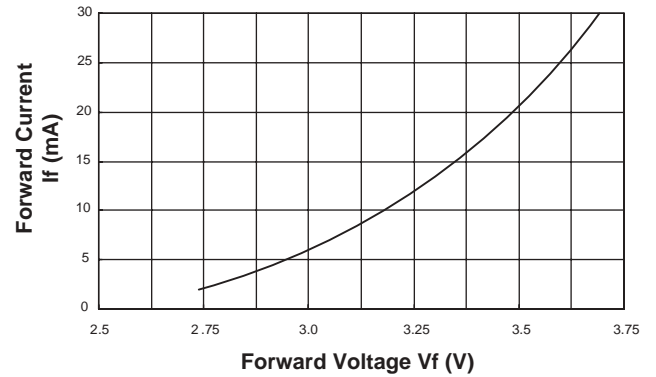

Forward Current vs. Derating curve

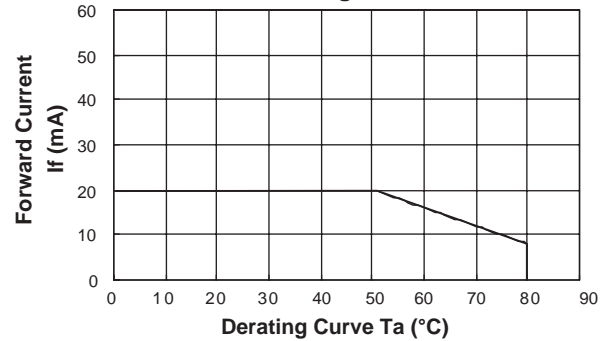

Beam Pattern

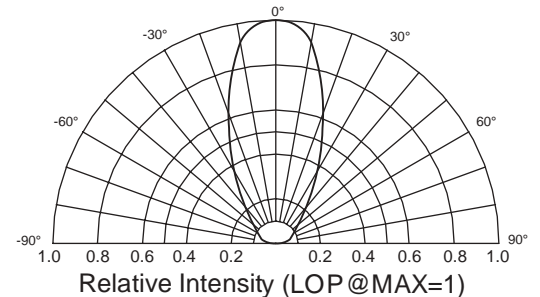

LED[®]
LEDTRONICS, INC.[™]
 23105 KASHIWA COURT
 TORRANCE, CA 90505

-PROPRIETARY-
 This document contains Proprietary information of LEDTRONICS, INC.[™] It may not be copied, used or disclosed for any purpose without the prior express written consent of LEDTRONICS, INC.[™]

.XXX ± .010 TOLERANCE PER ANSI-Y14.5
 .XX ± .025 (UNLESS OTHERWISE STATED)
 ANGLES ± 0°, 30'
 FRACT. ± 1/32

TITLE L200-0WW-40D					
DWG NO DSDC311-B		SCALE NTS		SHEET 3 OF 3	
CODE IDENT NO. 8Z410		DWG BY RM		DATE 12-09-05	
CHK BY QA		MNFG		CUSTOMER	